

**RigExpert<sup>®</sup>**

**AA-600**

**Antenna Analyzer  
0.1 to 600 MHz**

**AA-1000**

**Antenna Analyzer  
0.1 to 1000 MHz**

**User's manual**



# Table of contents

1. Description .....	4
2. Specifications .....	5
3. Precautions .....	6
4. Operation.....	7
4.1. Preparation for use .....	7
4.2. Turning the analyzer on or off.....	7
4.3. Main menu .....	8
4.4. Single- and multi-point measurement modes.....	9
4.4.1. SWR mode.....	9
4.4.2. SWR2Air mode .....	10
4.4.3. MultiSWR mode.....	11
4.4.4. Show all mode .....	12
4.5. Graph modes .....	13
4.5.1. SWR graph .....	13
4.5.2. R,X graph .....	14
4.5.3. Smith/polar chart.....	15
4.5.4. Data screen .....	15
4.5.5. Memory operation.....	16
4.5.6. Calibration .....	17
4.6. TDR (Time Domain Reflectometer) mode .....	20
4.6.1. Theory .....	20
4.6.2. Practice .....	23
4.7. Settings menu.....	24
4.8. Computer connection .....	28
5. Applications .....	29
5.1. Antennas .....	29
5.1.1. Checking the antenna.....	29
5.1.2. Adjusting the antenna .....	30
5.2. Coaxial lines .....	30
5.2.1. Open- and short-circuited cables.....	30
5.2.2. Cable length measurement .....	31
5.2.3. Velocity factor measurement .....	32
5.2.4. Cable fault location.....	33
5.2.5. Making $1/4\text{-}\lambda$ , $1/2\text{-}\lambda$ and other coaxial stubs.....	34
5.2.6. Measuring the characteristic impedance.....	35
5.3. Measurement of other elements.....	36
5.3.1. Capacitors and inductors.....	36
5.3.2. Transformers.....	38
5.3.3. Traps.....	38
5.4. RF signal generator .....	39

# 1. Description

RigExpert AA-600 and AA-1000 are powerful antenna analyzers designed for testing, checking, tuning or repairing antennas and antenna feedlines.

Graphical SWR (Standing Wave Ratio) and impedance, as well as Smith/polar chart displays are key features of these analyzers which significantly reduce the time required to adjust an antenna.

Easy-to use measurement modes, as well as additional features such as connection to a personal computer make RigExpert AA-600 and AA-1000 attractive for professionals and hobbyists.

The MultiSWR™ and SWR2Air™ modes are unique for RigExpert antenna analyzers.

The built-in TDR (Time Domain Reflectometer) mode is ideal for locating cable faults.

The following tasks are easily accomplished by using these analyzers:

- Rapid check-out of an antenna
- Tuning an antenna to resonance
- Comparing characteristics of an antenna before and after specific event (rain, hurricane, etc.)
- Making coaxial stubs or measuring their parameters
- Cable fault location
- Measuring capacitance or inductance of reactive loads

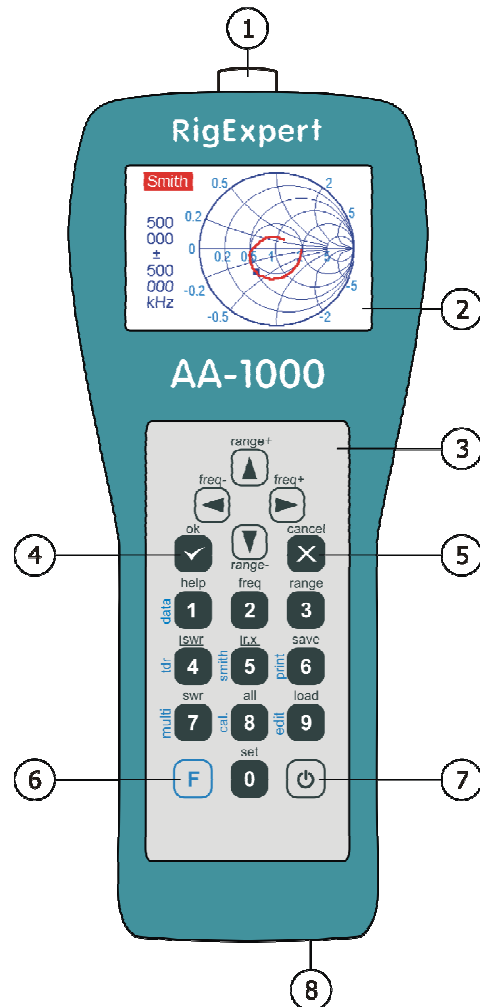

1. Antenna connector
2. LCD (Liquid Crystal Display)
3. Keypad
4. Ok button (start/stop measurement, enter)
5. Cancel button (exit to main menu, cancel)
6. Function button
7. Power on/off button
8. USB connector

## 2. Specifications

Frequency range: 0.1 to 600 MHz – AA-600

0.1 to 1000 MHz – AA-1000

Frequency entry: 1 kHz resolution

Measurement for 25, 50, 75 and 100-Ohm systems

SWR measurement range: 1 to 100 in numerical mode,  
1 to 10 in graph mode

SWR display: numerical or easily-readable bar

R and X range: 0...10000, -10000...10000 in numerical mode,  
0...1000, -1000...1000 in graph mode

Display modes:

- SWR at single or multiple frequencies
- SWR, return loss, R, X, Z, L, C at single frequency
- SWR graph, 80 points
- R, X graph, 80 points
- Smith/polar chart, 80 points
- TDR (Time Domain Reflectometer) graph

Optional open-short-load calibration in SWR, R,X or Smith/polar chart graph modes.

RF output:

- Connector type: N
- Output signal shape: rectangular, 0.1 to 200 MHz. For higher frequencies, harmonics of the main signal are used.
- Output power: -10 dBm (at 50 Ohm load)

Power:

- Three 1.5V, alkaline batteries, type AA
- Three 1.2V, 1800...3000 mA·h, Ni-MH batteries, type AA
- Max. 3 hours of continuous measurement, max. 2 days in stand-by mode when fully charged batteries are used
- When the analyzer is connected to a PC or a DC adapter with USB socket, it takes power from these sources

Interface:

- 320x240 color TFT display
- 6x3 keys on the water-proof keypad
- Multilingual menus and help screens
- USB connection to a personal computer

Dimensions: 23·10·5.5 cm (9·4·2")

Operating temperature: 0...40 °C (32...104 °F)

Weight: 650g (23 Oz)

### 3. Precautions



Never connect the analyzer to your antenna in thunderstorms. Lightning strikes as well as static discharge may kill the operator.



Never leave the analyzer connected to your antenna after you finished operating it. Occasional lightning strikes or nearby transmitters may permanently damage it.



Never inject RF signal into the analyzer. Do not connect it to your antenna if you have active transmitters nearby.



Avoid static discharge while connecting a cable to the analyzer. It is recommended to ground the cable before connecting it.



Do not leave the analyzer in active measurement mode when you are not actually using it. This may cause interference to nearby receivers.



If using a personal computer, first connect the cable to the antenna connector of the analyzer. Then plug the analyzer to the computer USB port. This will protect the analyzer from static discharges.

## 4. Operation

### *4.1. Preparation for use*

Open the cover on the bottom panel of the analyzer. Install three fully charged 1.2V Ni-MH (or three 1.5V alkaline) batteries, watching the polarity.

Do not:

- mix new and old batteries;
- use batteries of different types at the same time;
- overheat or disassemble batteries;
- short-circuit batteries;
- try to re-charge alkaline batteries.

To charge Ni-MH batteries, use charging adapters for this type of batteries. For longer battery life, it is recommended to use an adapter which charges each battery separately.

Any leaks of electrolyte from the batteries may seriously damage the analyzer.

Remove batteries if the analyzer is not being used for a long period of time. Store batteries in a dry cool place.

### *4.2. Turning the analyzer on or off*

To turn the analyzer on or off, use the  (power) button located in the bottom right corner of the keypad. When this button is pressed, firmware version number as well as battery voltage are displayed on the LCD.

The on-screen menu system of RigExpert antenna analyzers provides a simple but effective way to control the entire device.

### 4.3. Main menu

Once the analyzer is turned on, the *Main menu* appears on the LCD:

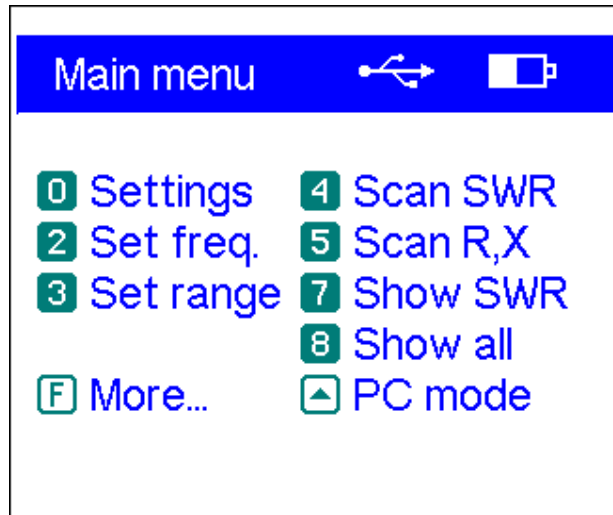

The *Main menu* contains a brief list of available commands. By pressing keys on the keypad, you may enter corresponding measurement modes, set up additional parameters, etc.

Pressing the **F** (function) key will immediately list additional commands:



There is a power indicator in the top-right corner of the *Main menu* screen:

- The *battery indicator* shows battery discharge level. When the battery voltage is too low, this indicator starts flashing.
- The *USB icon* is displayed when the analyzer is plugged to a personal computer or to a DC adapter with USB socket.

RigExpert AA-600 and AA-1000 antenna analyzers are self-documenting: pressing the **1** (help) key will open a help screen with a list of available keys for the current mode.



## 4.4. Single- and multi-point measurement modes

In single-point measurement modes, various parameters of antenna or other load are measured at a given frequency. In multi-point modes, several different frequencies are used.

### 4.4.1. SWR mode

The *SWR mode* (press the **7** key in the *Main menu*) displays the SWR bar as well as the numerical value of this parameter:

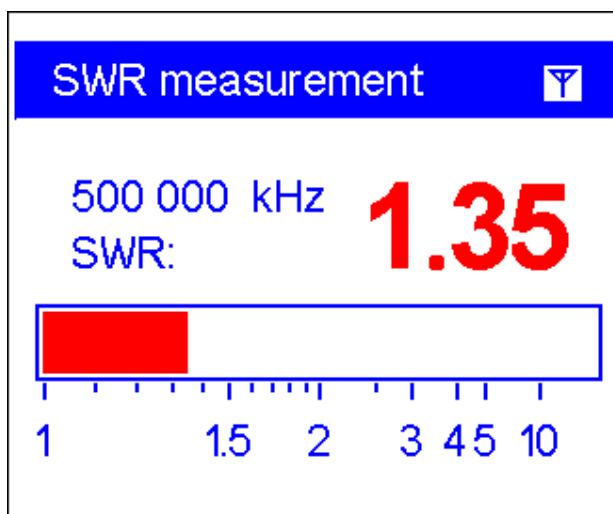

Set the desired frequency (the **2** key) or change it with left or right arrow keys.

Press the **✓** (ok) key to start or stop measurement. The flashing antenna icon in the top-right corner indicates when the measurement is started. Pressing the **1** (help) key will show a list of all available commands for this mode:

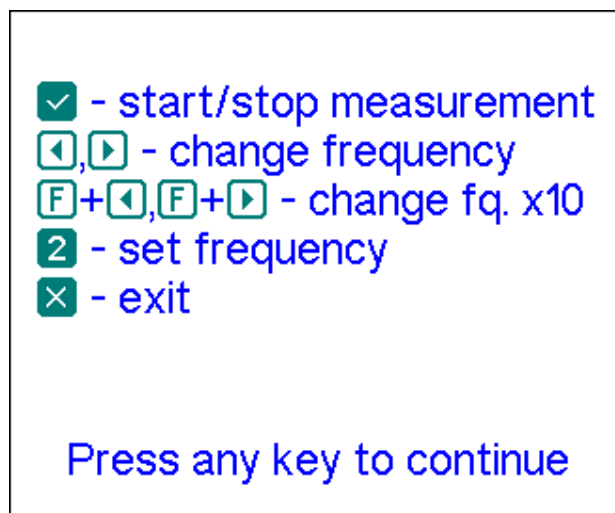

## 4.4.2. *SWR2Air mode*

RigExpert AA-600 and AA-1000 present a new *SWR2Air* mode which is designed to help in adjusting antennas connected via long cables.

This task usually involves two persons; one adjusting the antenna and the other shouting out the SWR value as it changes at the far end of the feedline.

There is an easier way to do the same job by using the *SWR2Air* mode. The result of SWR measurement is transmitted on a user specified frequency where it can be heard with a portable HF or VHF FM radio. The length of audio signal coming from the loudspeaker of the portable radio depends on the value of measured SWR.

The *SWR2Air* mode is activated by pressing **F** + **✓** key combination in the *SWR measurement* screen. **F** + **2** allows setting the frequency to tune the receiver to.

### 4.4.3. MultiSWR mode

RigExpert AA-600 and AA-1000 have an ability to display SWR for up to five different frequencies at a time. This mode is activated by pressing **F** + **7** key combination in the *Main menu*:

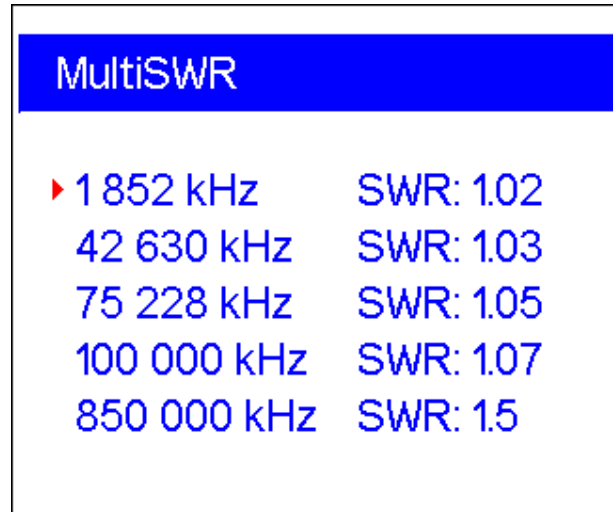

You may use this feature to tune multi-band antennas. Use **▲** (up) and **▼** (down) cursor keys to select a frequency to be set or changed. Press the **0** key to switch between SWR bars and numerical representation of this parameter:

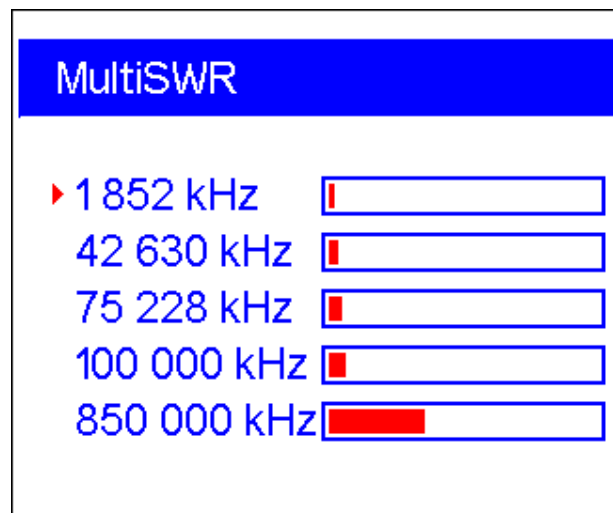

Pressing the **1** (help) key will show a list of other commands.

#### 4.4.4. Show all mode

The *Show all* mode (the **8** key) will show various parameters of a load on a single screen. Particularly, SWR, return loss (RL),  $|Z|$  (magnitude of impedance) as well as its active (R) and reactive (X) components are shown. Additionally, corresponding values of inductance (L) or capacitance (C) are displayed:

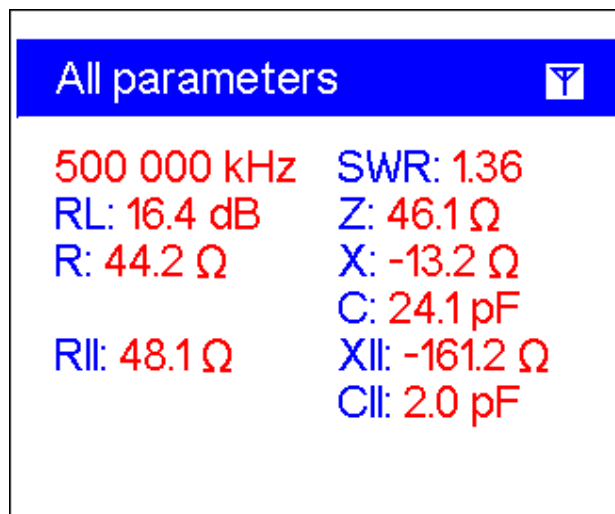

This screen displays values for *series* as well as *parallel* models of impedance of a load:

- In the series model, impedance is expressed as resistance and reactance connected in series:

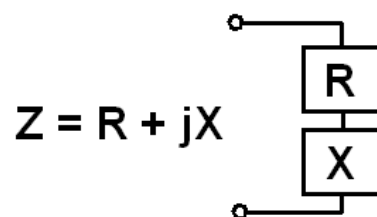

- In the parallel model, impedance is expressed as resistance and reactance connected in parallel:

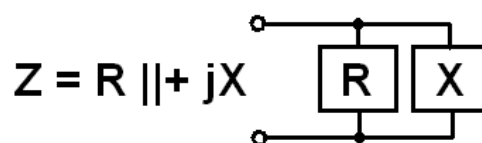

## 4.5. Graph modes

A key feature of RigExpert antenna analyzers is ability to display various parameters of a load graphically. Graphs are especially useful to view the behavior of these parameters over the specified frequency range.

### 4.5.1. SWR graph

In the *SWR graph* mode (press the **4** key in the *Main menu*), values of the Standing Wave Ratio are plotted over the specified frequency range:

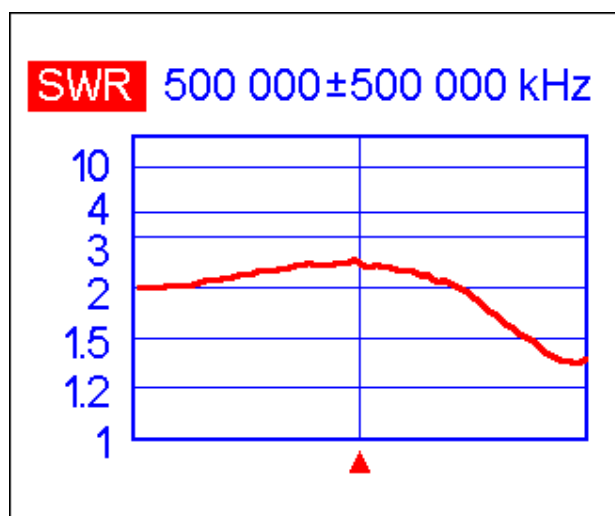

You may set the center frequency (the **2** key) or scanning range (the **3** key). By using arrow keys (**◀ ▶ ▲ ▼**), these parameters may be increased or decreased. Watch the triangle cursor below the graph.

Press the **✓** (ok) key to start measurement or refresh the graph.

The **0** key opens a list of radio amateur bands to set the required center frequency and scanning range quickly. Also, you may use this function to set the whole frequency range supported by the analyzer.

Press the **1** key to access a list of additional commands for this mode.

## 4.5.2. *R,X graph*

In the *R,X graph* mode (press the **5** key in the *Main menu*), values of R (active part of the impedance) and X (reactive part) are plotted in different colors.

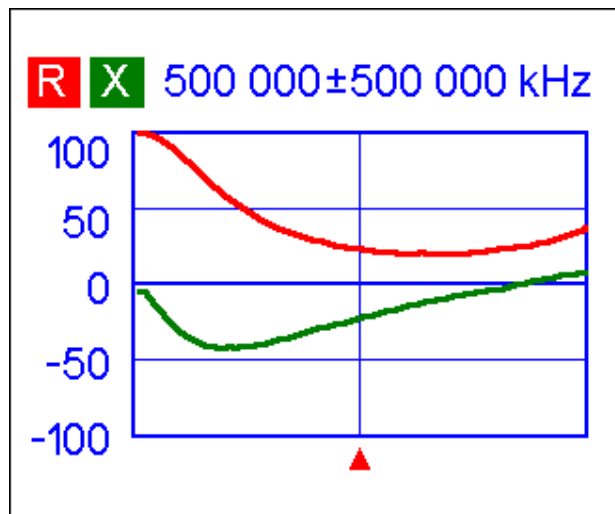

In these graphs, positive values of reactance (X) correspond to inductive load, while negative values correspond to capacitive load. Please notice the difference in the plots when series or parallel model of impedance is selected through the *Settings* menu:

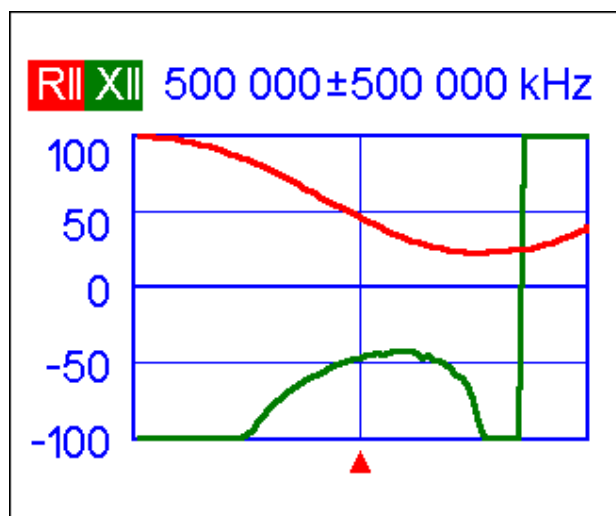

### 4.5.3. Smith/polar chart

The *Smith/polar chart* (press the **F** + **5** key combination in the *Main menu*) is a good way to display reflection coefficient over the specified frequency range:

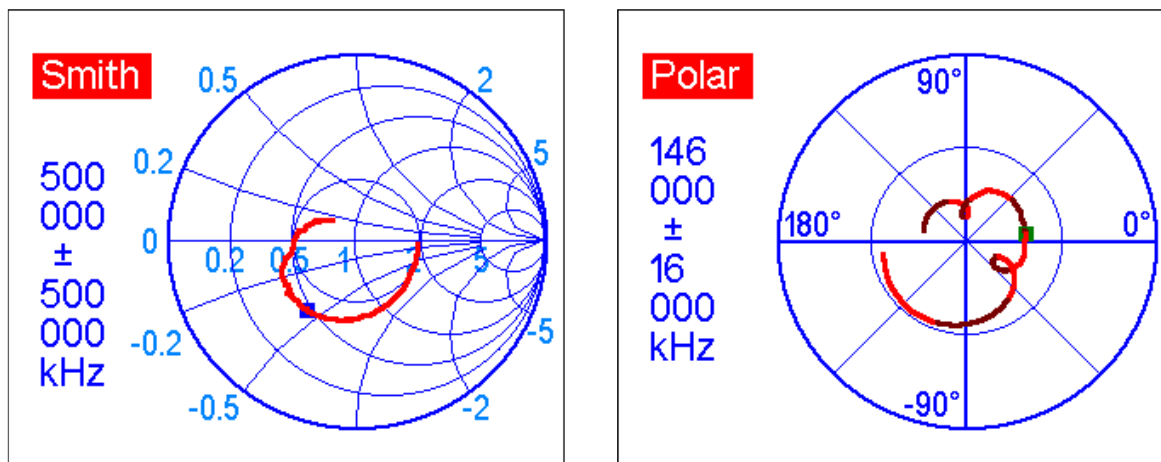

As usual, press the **1** key for a help screen.

*Please notice: Non-US version of analyzers will display Smith chart; a polar chart is displayed instead on US version.*

### 4.5.4. Data screen

In all graph modes, press **F** + **1** key combination to display various parameters at cursor:

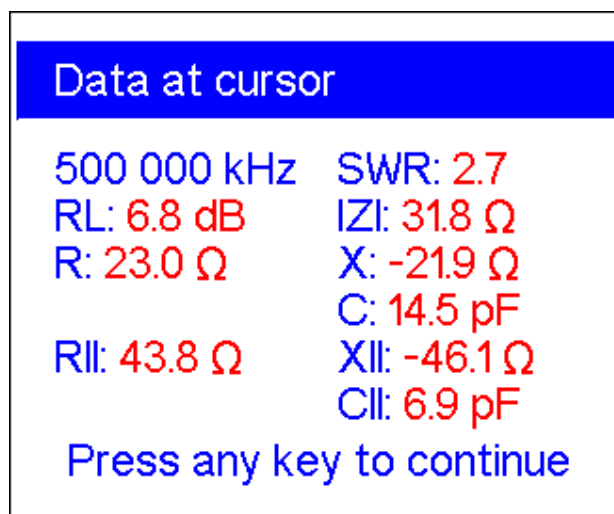

### 4.5.5. Memory operation

In all graph modes, you may choose to scan to memory (the **6** key):

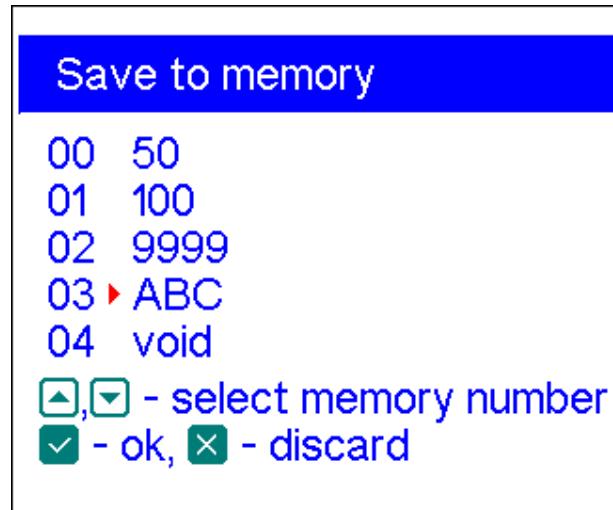

There are 90 independent memory slots. Later, you may recall (the **9** key) the plots from the specified memory.

Additionally, the **F** + **9** combination opens the editor of memory slot names:

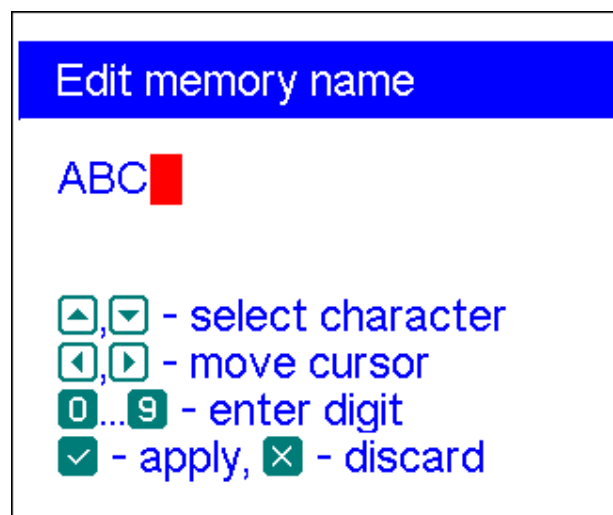



## 4.5.6. Calibration

Although RigExpert AA-600 and AA-1000 are designed for high performance without any calibration, an open-short-load calibration may be applied for better precision.

The standards used for calibration should be of high quality. This requirement is especially important for high frequencies (100 MHz and upper). Three different calibration standards should be used: an “open”, a “short” and a “load” (usually, a 50-Ohm resistor). A place where these standards are connected during calibration is called a *reference plane*. If the calibration is done at the far end of a transmission line, parameters of this line will be subtracted from measurement results and the analyzer will display “true” parameters of a load.

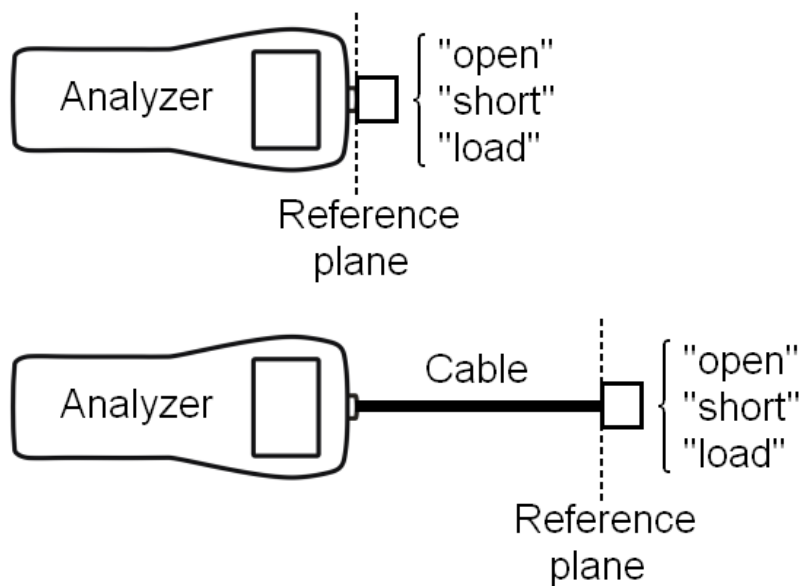

To perform calibration,

1. Enter the *SWR graph* (the **4** key), the *R,X graph* (the **5** key) or the *Smith/polar chart* (the **F** + **5** key combination) mode.
2. Select the desired center frequency and the sweep range.

3. By pressing the **F** + **8** key combination, open the *Calibration screen*:

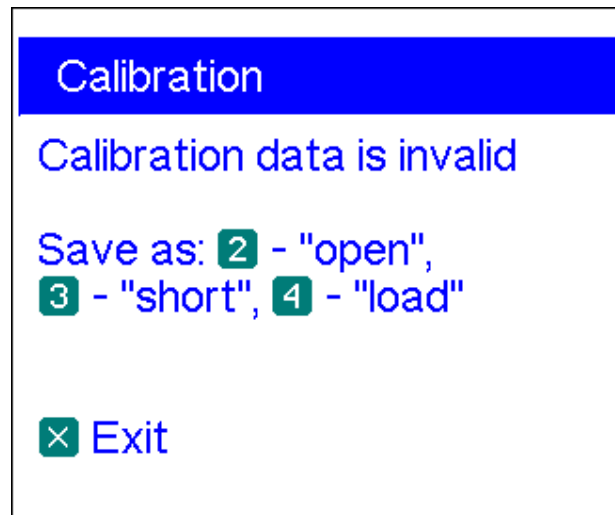

4. Connect an “open” to the analyzer and press the **2** key. The analyzer will rescan the specified frequency range and save calibration data to its memory.

5. Connect a “short” and press the **3** key.

6. Connect a “load” and press the **4** key. Please notice that for displaying the *SWR graph* and the *Smith/polar chart* correctly, the *System impedance* parameter in the *Settings menu* (see page 24) should be same as the actual resistance of the “load”.

After the parameters of all three loads are measures, a “cal” indicator appears at the bottom of the display:

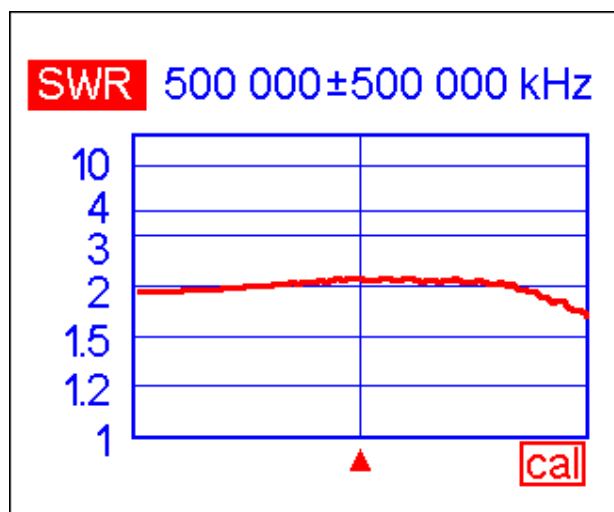

Changing the center frequency or the sweep range will invalidate calibration.

Additionally, pressing the **5** key in the *Calibration screen* will invalidate the current calibration, and pressing the **6** key will return the analyzer to the center frequency and the sweep range used during the last calibration:

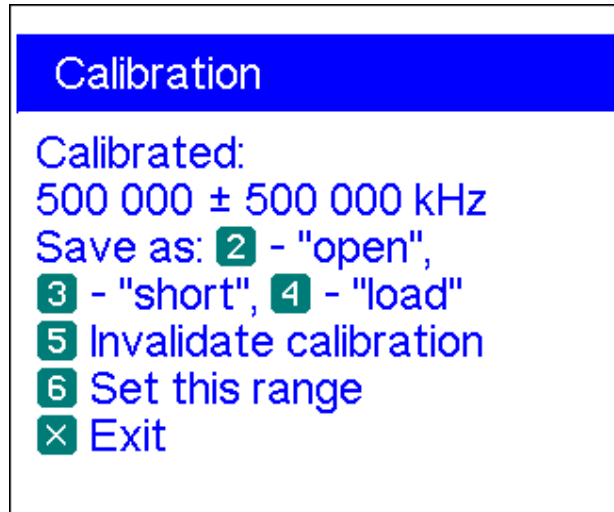

## 4.6. TDR (Time Domain Reflectometer) mode

### 4.6.1. Theory

Time domain reflectometers are electronic instruments used for locating faults in transmission lines.

A short electrical pulse is sent over the line, and then a reflected pulse is observed. By knowing the delay between two pulses, the speed of light and the cable velocity factor, the DTF (distance-to-fault) is calculated. The amplitude and the shape of the reflected pulse give the operator idea about the nature of the fault.

Impulse response:

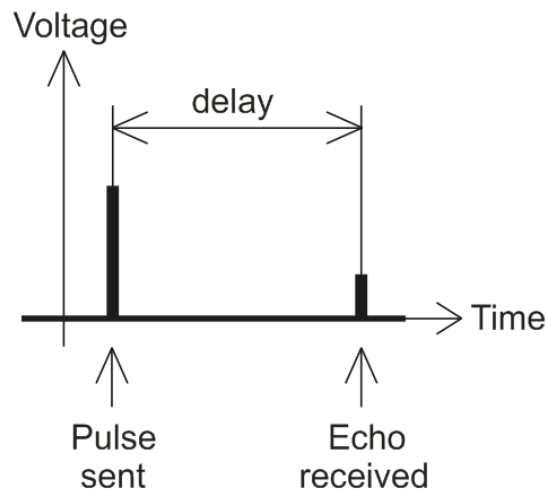

Instead of a short pulse, a “step” function may be sent over the cable.

Step response:

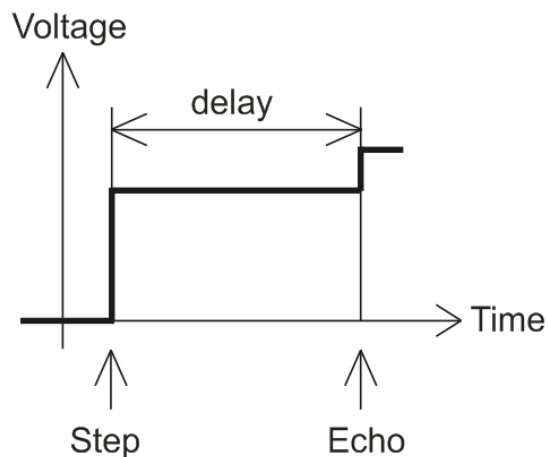

Unlike many other commercially-available reflectometers, RigExpert AA-600 and AA-1000 do not send pulses into the cable. Instead, another technique is used. First, R and X (the real and the imaginary part of the impedance) are measured over the whole frequency range (up to 600 or 1000 MHz). Then, the IFFT (Inverse Fast Fourier Transform) is applied to the data. As a result, impulse response and step response are calculated.

(This method is often called a “Frequency Domain Reflectometry”, but the “TDR” term is used in this document since all calculations are made internally and the user can only see the final result.)

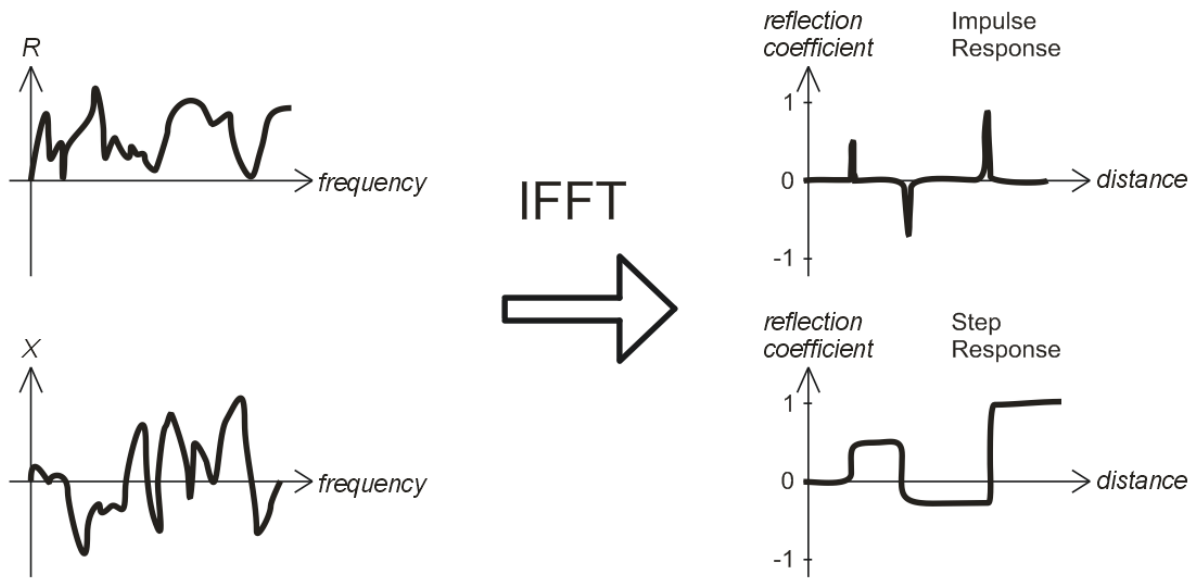

The vertical axis of the resulting graphs displays the reflection coefficient:  $\Gamma = -1$  for short load, 0 for matched impedance load ( $Z_{Load} = Z_0$ ), or  $+1$  for open load. By knowing the cable velocity factor, the horizontal axis is shown in the units of length.

Single or multiple discontinuities can be displayed on these graphs. While the Impulse Response graph is suitable for measuring distance, the Step Response graph helps in finding the cause of a fault.

See the examples of typical Step Response graphs on the next page.

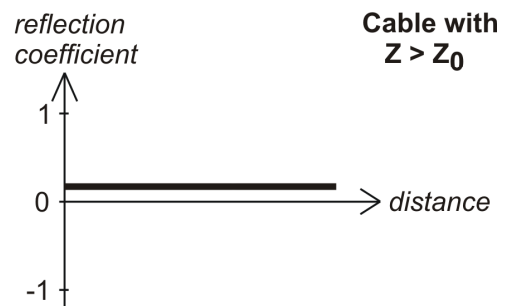
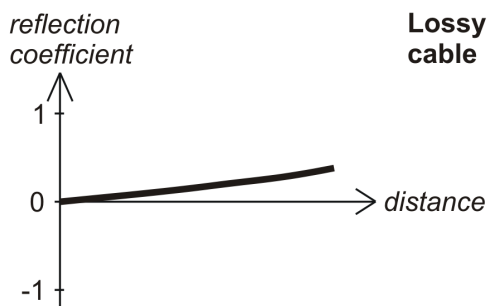
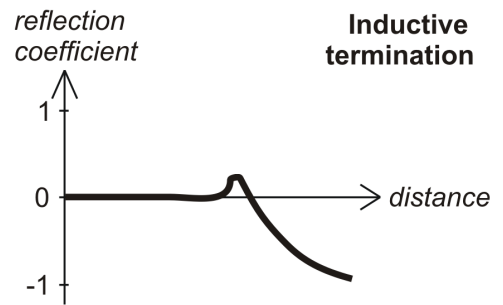
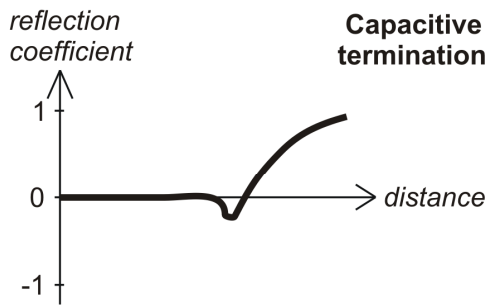
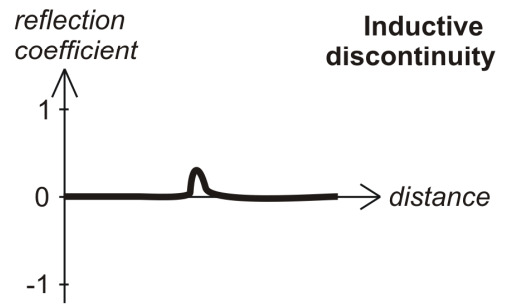
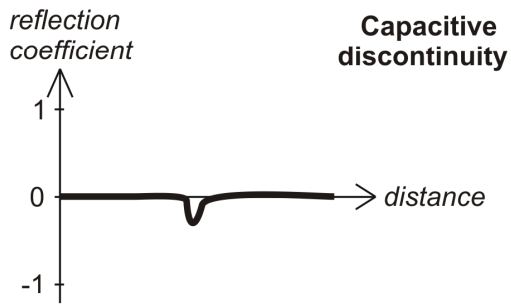
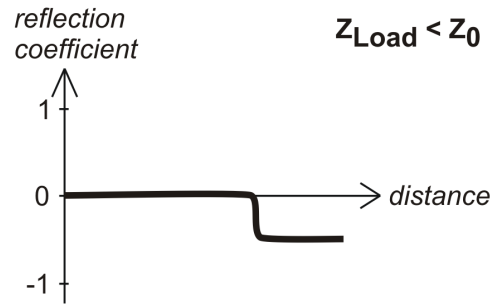
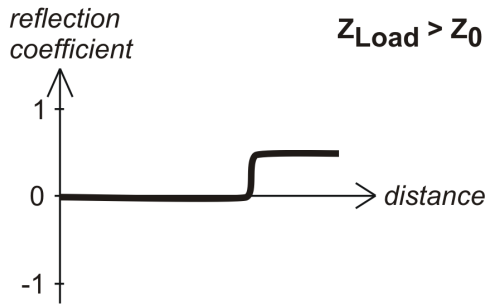
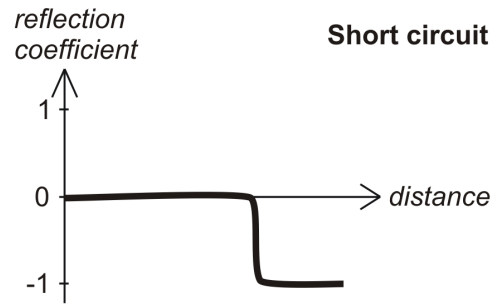
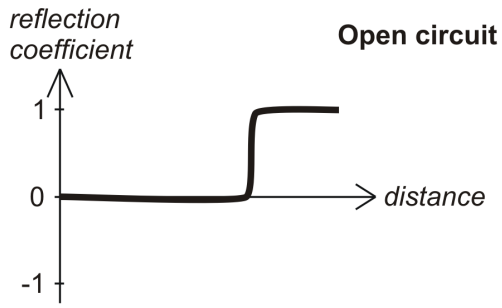

## 4.6.2. Practice

Press **F** + **4** to open Impulse Response (IR) and Step Response (SR) graphs:

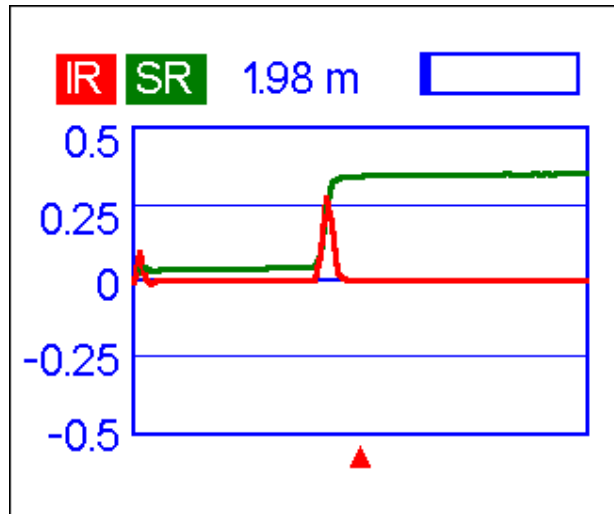

The characteristic impedance and the velocity factor of the cable, as well as display units (meters or feet) may be changed in the *Settings menu*.

The **✓** (ok) key starts a new measurement, which will take about a minute. You may disconnect your antenna or leave it connected to the far end of the cable. This will only affect the part of the graph located behind the far end of the cable.

Use the arrow keys to move the cursor or to change the display range. Watch the navigation bar at the top-right corner of the screen to see the current position of the displayed part of the graph.

The **6** key will start a new measurement, saving results in one of 10 memory slots. The **9** key will retrieve saved data. Use the **F** + **9** combination to edit memory names, if needed.

Pressing **F** + **1** opens a data screen which displays numerical values of impulse and step response coefficients, as well as Z (estimated impedance) at cursor.

The **1** key will display the help screen, as usual.

## 4.7. Settings menu

The *Settings menu* (press the **0** key in the *Main menu*) contains various settings for the analyzer. The first page contains the following commands:

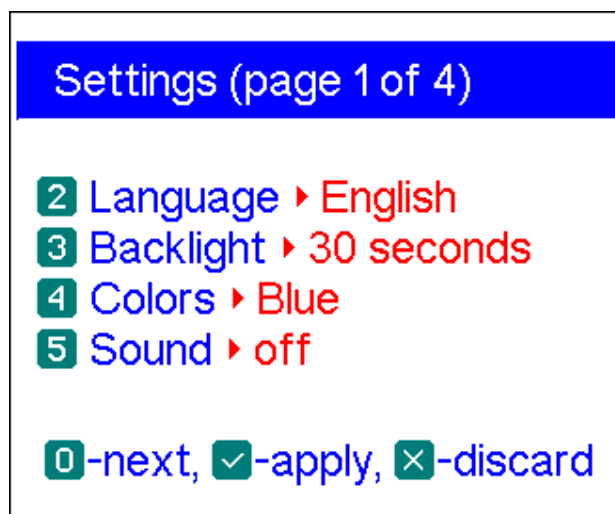

- 2** – language selection
- 3** – backlight brightness and timer
- 4** – colour scheme selection
- 5** – sound on or off
- 0** – go to the second page which contains additional settings

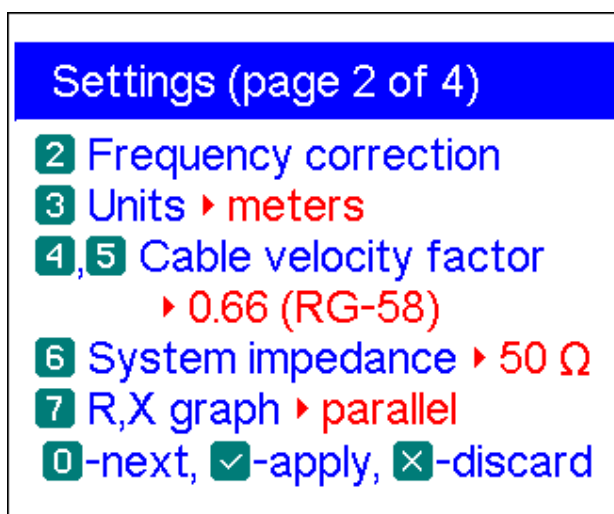

- 2** – opens a frequency correction screen, so the output frequency of the analyzer may be set precisely
- 3** – select metric or U.S. units for the TDR display



- 4 and 5 – select cable velocity factor for the TDR display
- 6 – select system impedance for SWR, Smith/polar chart and TDR displays
- 7 – select series or parallel representation (see page 12) for the R,X graph
- 0 – go to the third page which contains analyzer self-test options

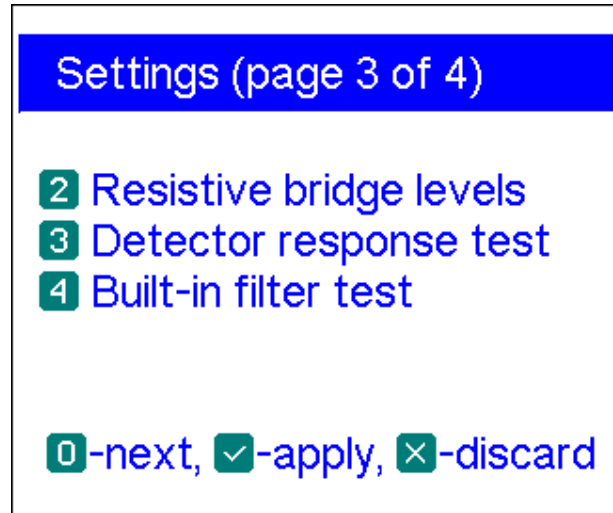

2 – RF bridge test. Two filled bars display signal levels at the left and at the right legs of the resistive bridge. With no load at the antenna connector, the screen should look like shown on the picture:

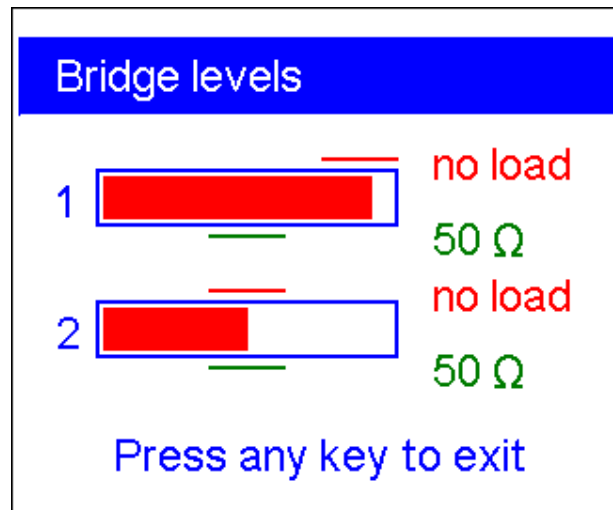

For the 50-Ohm load, the filled bars should stand at corresponding positions (notice the “no load” and “50 Ω” marks):

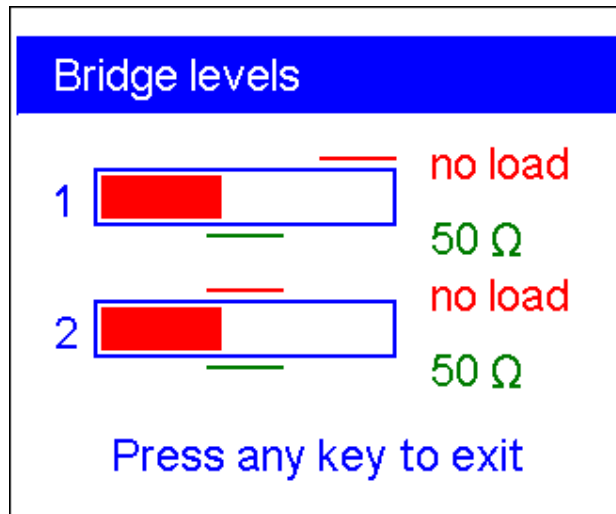

If the bars are not filled at all, the RF output stage or/and the detector are not working properly in the analyzer.

3 – detector output voltage vs. frequency graph. With no load at the antenna connector, the display should look like shown on the picture:

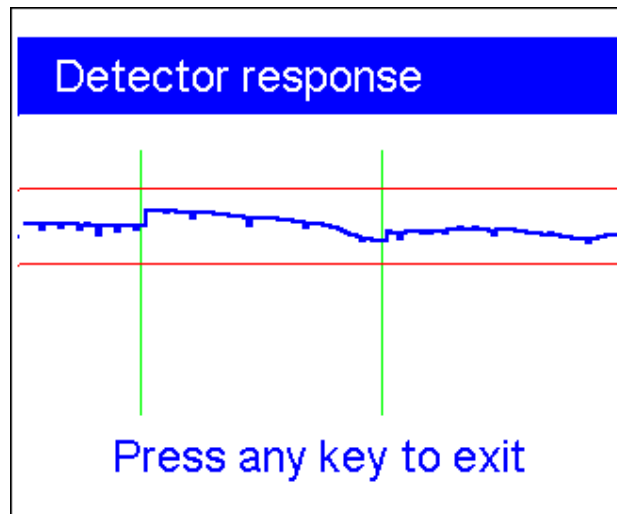

The voltage curve should stay between horizontal lines. The vertical lines are the bounds of analyzer's subbands.

**4** – bandpass filter frequency response graph. With no load at the antenna connector, the display should look like shown on the picture:

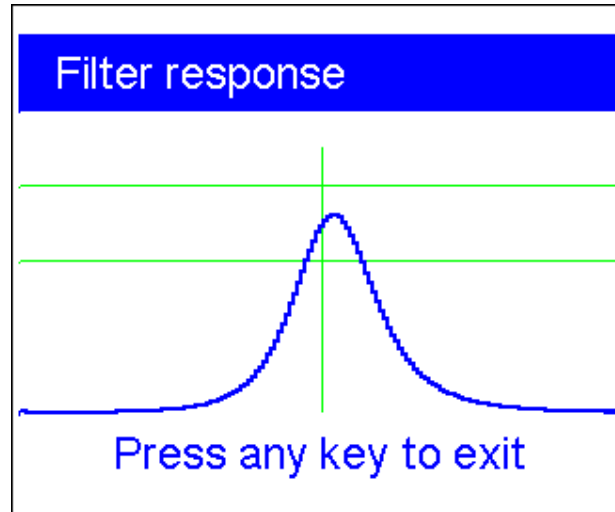

The top of the curve should be located in the middle of the screen, between two horizontal lines. A small horizontal shift of the curve is allowed.

**0** – go to the last page which contains reset commands

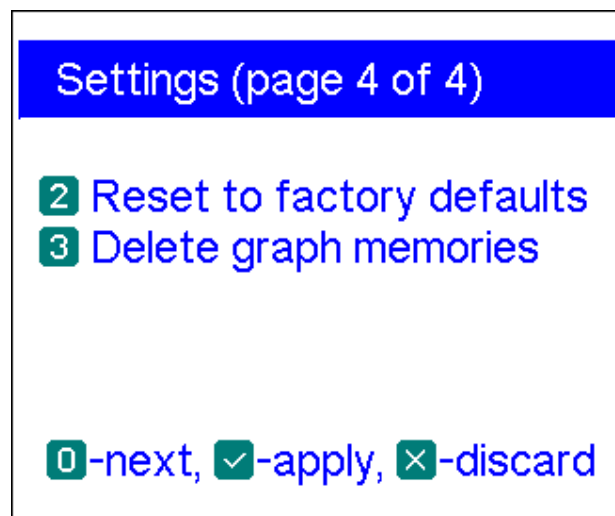

**2** – reset the entire analyzer to factory defaults

**3** – delete all graph memories

**0** – go to the last page of the settings menu

## ***4.8. Computer connection***

RigExpert AA-600 and AA-1000 antenna analyzers may be connected to a personal computer for displaying measurement results on its screen, taking screen shots of the LCD, as well as for updating the firmware.

A conventional USB cable may be used for this purpose. The supporting software is located on the supplied CD or may be downloaded from the [www.rigexpert.com](http://www.rigexpert.com) website. Please see the *Software Manual* for details.

## 5. Applications

### 5.1. Antennas

#### 5.1.1. Checking the antenna

It is a good idea to check an antenna before connecting it to the receiving or transmitting equipment. The *SWR graph* mode is good for this purpose:

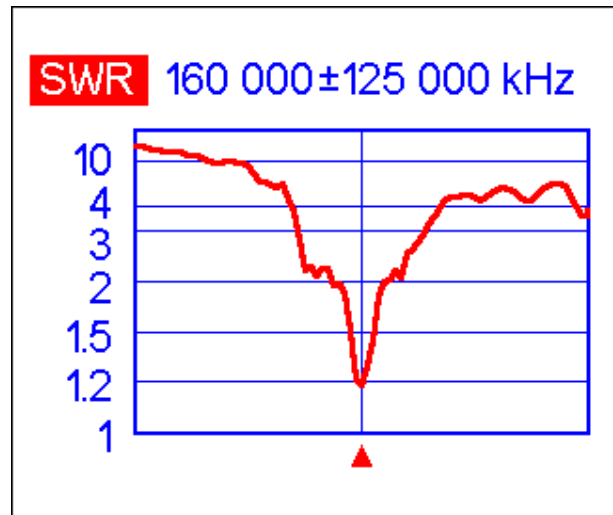

The above picture shows SWR graph of a car VHF antenna. The operating frequency is 160 MHz. The SWR at this frequency is about 1.2, which is acceptable.

The next screen shot shows SWR graph of another car antenna:

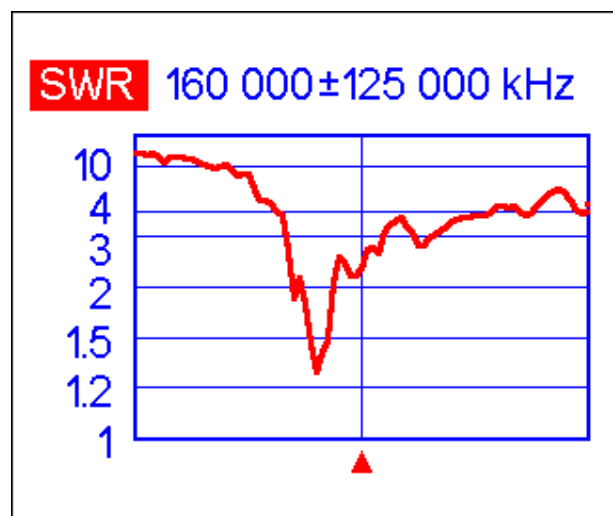

The actual resonant frequency is about 135 MHz, which is too far from the desired one. The SWR at 160 MHz is 2.7, which is not acceptable in most cases.

## 5.1.2. Adjusting the antenna

When the measurement diagnoses that the antenna is off the desired frequency, the analyzer can help in adjusting it.

Physical dimensions of a simple antenna (such as a dipole) can be adjusted knowing the actual resonant frequency and the desired one.

Other types of antennas may contain more than one element to adjust (including coils, filters, etc.), so this method will not work. Instead, you may use the *SWR mode*, the *Show all mode* or the *Smith/polar chart mode* to continuously see the results while adjusting various parameters of the antenna.

For multi-band antennas, use the *Multi SWR mode*. You can easily see how changing one of the adjustment elements (trimming capacitor, coil, or physical length of an aerial) affects SWR at up to five different frequencies.

## 5.2. Coaxial lines

### 5.2.1. Open- and short-circuited cables

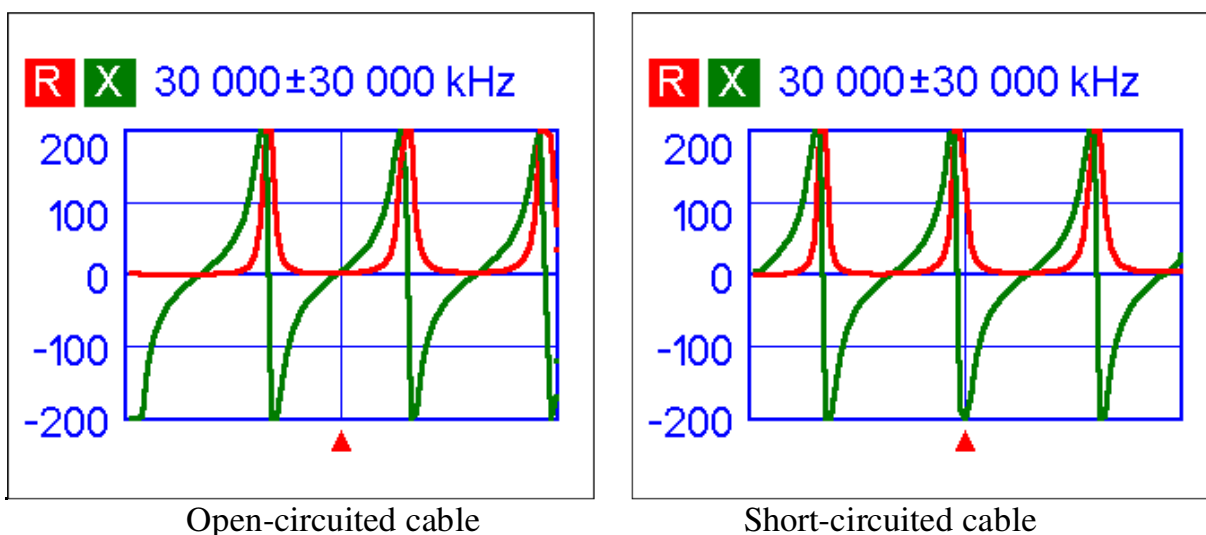

The above pictures show R and X graphs for a piece of cable with open- and short-circuited far end. A *resonant frequency* is a point at which X (reactance) equals to zero:

- In the open-circuited case, resonant frequencies correspond to (left to right)  $1/4$ ,  $3/4$ ,  $5/4$ , etc. of the wavelength in this cable;
- For the short-circuited cable, these points are located at  $1/2$ ,  $1$ ,  $3/2$ , etc. of the wavelength.

## 5.2.2. Cable length measurement

Resonant frequencies of a cable depend on its length as well as on the velocity factor.

A *velocity factor* is a parameter which characterizes the slowdown of the speed of the wave in the cable compared to vacuum. The speed of wave (or light) in vacuum is known as *the electromagnetic constant*:  $c=299,792,458$  meters per second or 983,571,056 feet per second.

Each type of cable has different velocity factor: for instance, for RG-58 it is 0.66. Notice that this parameter may vary depending on the manufacturing process and materials the cable is made of.

To measure the physical length of a cable,

1. Locate a resonant frequency by using single-point measurement mode or R,X graph.

Example:

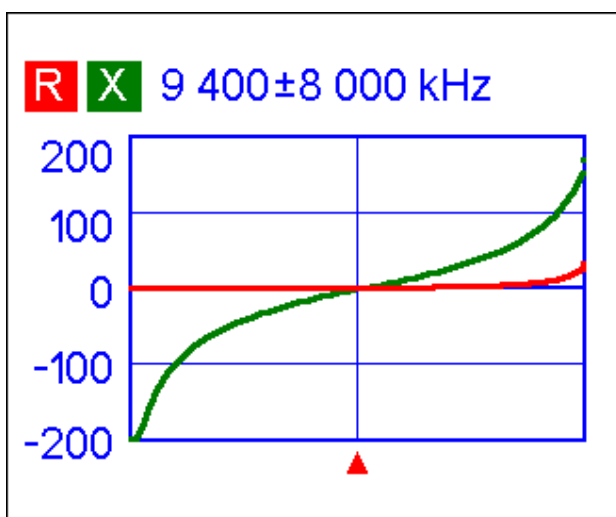

The 1/4-wave resonant frequency of the piece of open-circuited RG-58 cable is 9400 kHz

2. Knowing the electromagnetic constant and the velocity factor of the particular type of cable, find the speed of electromagnetic wave in this cable.

Example:

$$299,792,458 \cdot 0.66 = 197,863,022 \text{ meters per second}$$

- or -

$$983,571,056 \cdot 0.66 = 649,156,897 \text{ feet per second}$$

3. Calculate the physical length of the cable by dividing the above speed by the resonant frequency (in Hz) and multiplying the result by the number which corresponds to the location of this resonant frequency (1/4, 1/2, 3/4, 1, 5/4, etc.)

Example:

$$197,863,022 / 9,400,000 \cdot (1/4) = 5.26 \text{ meters}$$

- or -

$$649,156,897 / 9,400,000 \cdot (1/4) = 17.26 \text{ feet}$$

### ***5.2.3. Velocity factor measurement***

For a known resonant frequency and physical length of a cable, the actual value of the velocity factor can be easily measured:

1. Locate a resonant frequency as described above.

Example:

5 meters (16.4 feet) of open-circuited cable.

Resonant frequency is 9400 kHz at the 1/4-wave point.

2. Calculate the speed of electromagnetic wave in this cable. Divide the length by 1/4, 1/2, 3/4, etc. (depending on the location of the resonant frequency), then multiply by the resonant frequency (in Hz).

Example:

$$5 / (1/4) \cdot 9,400,000 = 188,000,000 \text{ meters per second}$$

- or -

$$16.4 / (1/4) \cdot 9,400,000 = 616,640,000 \text{ feet per second}$$

3. Finally, find the velocity factor. Just divide the above speed by the electromagnetic constant.

Example:

$$188,000,000 / 299,792,458 = 0.63$$

- or -

$$616,640,000 / 983,571,056 = 0.63$$



## 5.2.4. Cable fault location

To locate the position of the probable fault in the cable, just use the same method as when measuring its length. Watch the behavior of the reactive component (X) near the zero frequency:

- If the value of X is moving from  $-\infty$  to 0, the cable is open-circuited.
- If the value of X is moving from 0 to  $+\infty$ , the cable is short-circuited.

By using a TDR (Time Domain Reflectometer) mode, even minor discontinuities may be located in the transmission line.

Example:

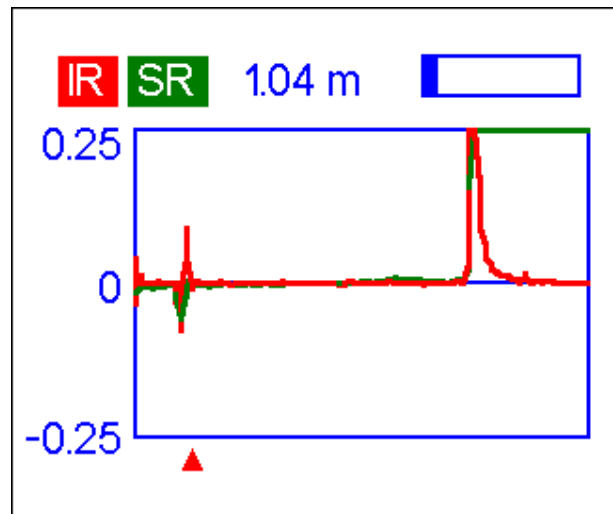

The TDR mode shows a visible peak at 1.04 meters, where two 50-Ohm cables are joined. A peak at 6 meters indicates open-circuit at the end of the cable.

### 5.2.5. Making 1/4-λ, 1/2-λ and other coaxial stubs

Pieces of cable of certain electrical length are often used as components of baluns (balancing units), transmission line transformers or delay lines.

To make a stub of the predetermined electrical length,

1. Calculate the physical length. Divide the electromagnetic constant by the required frequency (in Hz). Multiply the result by the velocity factor of the cable, then multiply by the desired ratio (in respect to λ).

Example:

1/4- λ stub for 28.2 MHz, cable is RG-58 (velocity factor is 0.66)

$$299,792,458 / 28,200,000 \cdot 0.66 \cdot (1/4) = 1.75 \text{ meters}$$

- or -

$$983,571,056 / 28,200,000 \cdot 0.66 \cdot (1/4) = 5.75 \text{ feet}$$

2. Cut a piece of cable slightly longer than this value. Connect it to the analyzer. The cable must be open-circuited at the far end for 1/4-λ, 3/4-λ, etc. stubs, and short-circuited for 1/2-λ, λ, 3/2-λ, etc. ones.

Example:

A piece of 1.85 m (6.07 ft) was cut. The margin is 10 cm (0.33 ft). The cable is open-circuited at the far end.

3. Switch the analyzer to the *Show all* measurement mode. Set the frequency the stub is designed for.

Example:

28,200 kHz was set.

4. Cut little pieces (1/10 to 1/5 of the margin) from the far end of the cable until the X value falls to zero (or changes its sign). Do not forget to restore the open-circuit, if needed.

Example:

11 cm (0.36 ft) were cut off.

## 5.2.6. Measuring the characteristic impedance

The *characteristic impedance* is one of the main parameters of any coaxial cable. Usually, its value is printed on the cable by the manufacturer. However, in certain cases the exact value of the characteristic impedance is unknown or is in question.

To measure the characteristic impedance of a cable,

1. Connect a non-inductive resistor to the far end of the cable. The exact value of this resistor is not important. However, it is recommended to use 50 to 100 Ohm resistors.

Example 1: 50-Ohm cable with 100 Ohm resistor at the far end.

Example 2: Unknown cable with 50 Ohm resistor at the far end.

2. Enter the *R,X graph* mode and make measurement in a reasonably large frequency range (for instance, 0 to 50 MHz).

Example 1: 50-Ohm cable

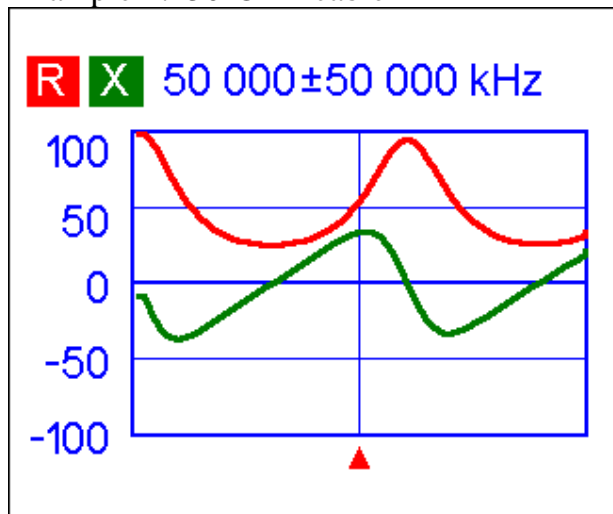

Example 2: Unknown cable

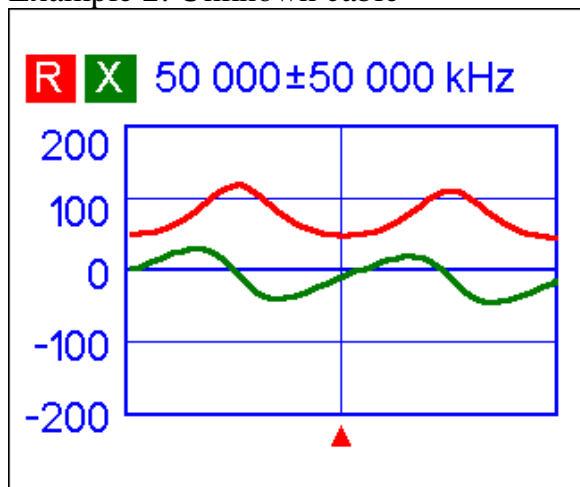

3. Changing the display range and performing additional scans, find a frequency where R (resistance) reaches its maximum, and another frequency with minimum. At these points, X (reactance) will cross the zero line.

Example 1: 28.75 MHz – min., 60.00 MHz – max.

Example 2: 25.00 MHz – max., 50.00 MHz – min.

4. Switch the *Data at cursor* screen by pressing **F** + **1** and find values of R at previously found frequencies.

Example 1: 25.9 Ohm – min., 95.3 Ohm – max.

Example 2: 120.6 Ohm – max, 49.7 Ohm – min.

5. Calculate the square root of the product of these two values.

Example 1: square root of  $(25.9 \cdot 95.3) = 49.7$  Ohm

Example 2: square root of  $(120.6 \cdot 49.7) = 77.4$  Ohm

### ***5.3. Measurement of other elements***

Although RigExpert antenna analyzers are designed for use with antennas and antenna-feeder paths, they may be successfully used to measure parameters of other RF elements.

#### ***5.3.1. Capacitors and inductors***

Analyzers can measure capacitance from a few pF to about 0.1  $\mu$ F as well as inductance from a few nH to about 100  $\mu$ H.

Be sure to place the capacitor or the inductor as close as possible to the RF connector of the analyzer.

1. Enter the R,X graph mode and select a reasonably large scanning range. Perform a scan.

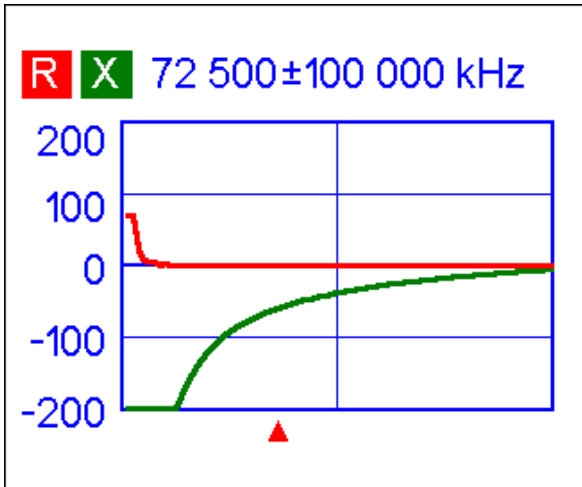

Example 1:  
Unknown capacitor

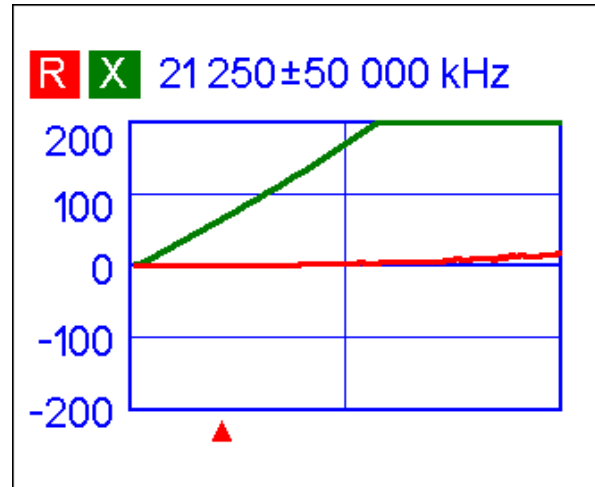

Example 2:  
Unknown inductor

2. By using left and right arrow keys, scroll to the frequency where X is -25...-100 Ohm for capacitors or 25...100 Ohm for inductors. Change the scanning range and perform additional scans, if needed.
3. Switch to the *Data at cursor* mode by pressing **F** + **1** and read the value of capacitance or inductance.

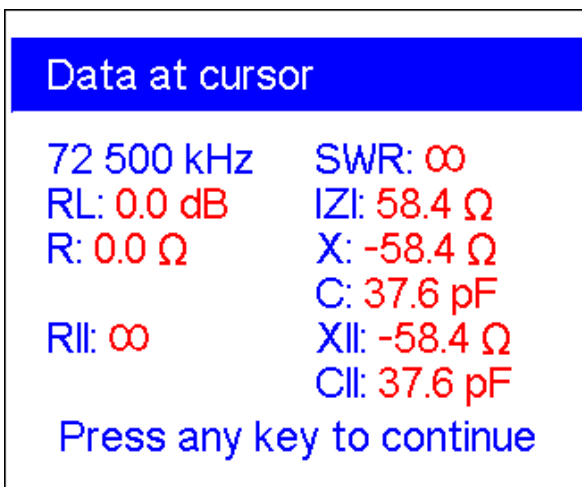

Example 1:  
Unknown capacitor

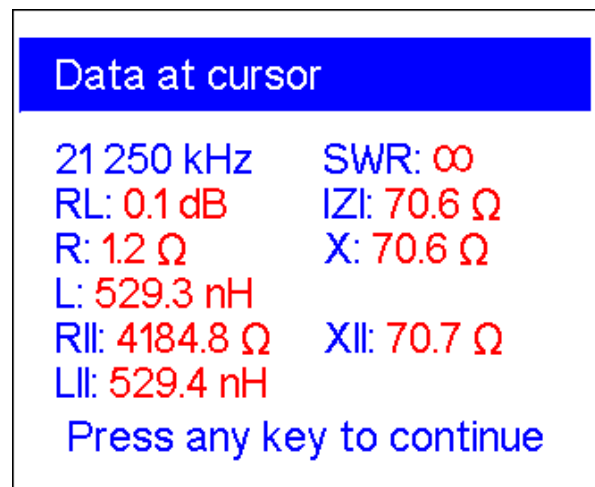

Example 2:  
Unknown inductor

### 5.3.2. Transformers

RigExpert analyzers can also be used for checking RF transformers. Connect a 50 Ohm resistor to the secondary coil (for 1:1 transformers) and use *SWR graph*, *R,X graph* or *Smith/polar chart* modes to check the frequency response of the transformer. Similarly, use resistors with other values for non-1:1 transformers.

### 5.3.3. Traps

A *trap* is usually a resonant L-C network used in multi-band antennas. By using a simple one-turn wire coil a resonant frequency of a trap may be measured.

Example:

A coaxial trap constructed of 5 turns of TV cable (coil diameter is 60 mm) was measured:

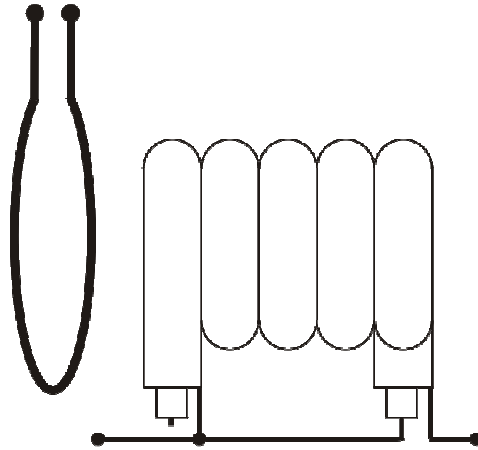

A one-turn coil connected to the analyzer was placed a few centimeters away from the measured trap. The SWR graph shows a visible dip near 17.4 MHz, which is a resonant frequency of the trap.

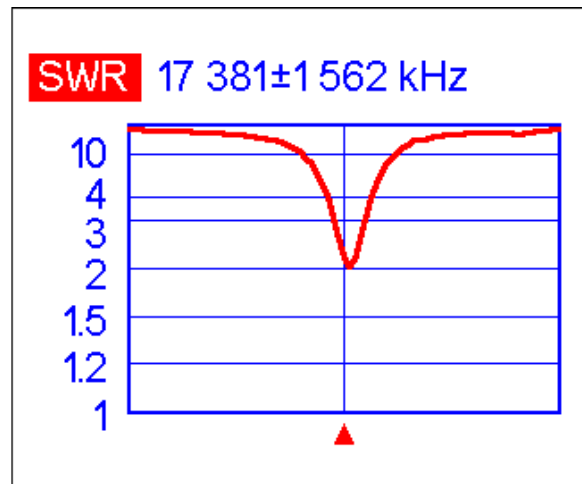

## ***5.4. RF signal generator***

The output signal of RigExpert AA-600 and AA-1000 has rectangular waveform and level of about -10 dBm (at the 50 Ohm load). Therefore these analyzers can be used as sources of RF signal for various purposes.

For frequencies up to 200 MHz, first harmonic of output signal can be used; in the range of 200 to 600 MHz – third harmonic; in the range of 600 to 1000 MHz – fifth harmonic.

Enter the *SWR mode* or the *Show all mode*, and press the  (ok) key to start the RF output.

If needed, use the frequency correction option in the *Settings menu* (see page 24).

Copyright © 2011-2012 Rig Expert Ukraine Ltd.

<http://www.rigexpert.com>

*RigExpert* is a registered trademark of Rig Expert Ukraine Ltd.



Printed in Ukraine

08-Aug-2012