

icom

IDAS
icom DIGITAL ADVANCED SYSTEM

INSTRUCTION MANUAL

VHF dPMR HANDHELD TRANSCEIVER

IC-F3102D

IC-F3103D

UHF dPMR HANDHELD TRANSCEIVER

IC-F4102D

IC-F4103D



The photo shows the VHF transceiver.

icom Inc.

FOREWORD



Thank you for choosing this Icom product. This product is designed and built with Icom's state of the art technology and craftsmanship. With proper care this product should provide you with years of trouble-free operation.

READ ALL INSTRUCTIONS carefully and completely before using the transceiver.

SAVE THIS INSTRUCTION MANUAL— This instruction manual contains important operating instructions for the **IC-F3102D, IC-F3103D VHF dPMR HANDHELD TRANSCEIVERS** and the **IC-F4102D, IC-F4103D UHF dPMR HANDHELD TRANSCEIVERS**.

 This instruction manual includes some functions which are usable only when they are preset by your dealer. Ask your dealer for details.

EXPLICIT DEFINITIONS

WORD	DEFINITION
 DANGER!	Personal death, serious injury or an explosion may occur.
 WARNING!	Personal injury, fire hazard or electric shock may occur.
CAUTION	Equipment damage may occur.
NOTE	If disregarded, inconvenience only. No risk of personal injury, fire or electric shock.

VOICE CODING TECHNOLOGY

The AMBE+2™ voice coding Technology embodied in this product is protected by intellectual property rights including patent rights, copyrights and trade secrets of Digital Voice Systems, Inc. This voice coding Technology is licensed solely for use within this Communications Equipment. The user of this Technology is explicitly prohibited from attempting to extract, remove, decompile, reverse engineer, or disassemble the Object Code, or in any other way convert the Object Code into a human-readable form. U.S. Patent Nos.

#5,870,405, #5,826,222, #5,754,974, #5,701,390, #5,715,365, #5,649,050, #5,630,011, #5,581,656, #5,517,511, #5,491,772, #5,247,579, #5,226,084 and #5,195,166.

Icom is not responsible for the destruction or damage to the Icom transceiver, if the malfunction is because of:

- Force majeure, including, but not limited to, fires, earthquakes, storms, floods, lightnings, or other natural disasters, disturbances, riots, war, or radioactive contamination.
- The use of Icom transceiver with any equipment that is not manufactured or approved by Icom.

Icom, Icom Inc. and Icom logo are registered trademarks of Icom Incorporated (Japan) in Japan, the United States, the United Kingdom, Germany, France, Spain, Russia, Australia, New Zealand, and/or other countries.

IDAS is trademark of Icom Incorporated (Japan).

dPMR and the dPMR logo are trademarks of the dPMR MoU Association.

All other products or brands are registered trademarks or trademarks of their respective holders.

PRECAUTIONS

⚠ **DANGER! NEVER** short terminals of the battery pack. Also, current may flow into nearby metal objects such as a necklace, so be careful when placing battery packs (or the transceiver) in handbags, etc. Simply carrying with or placing near metal objects such as a necklace, etc. may cause shorting. This may damage not only the battery pack, but also the transceiver.

⚠ **DANGER!** Use and charge only specified Icom battery packs with Icom transceivers or Icom chargers. Only Icom battery packs are tested and approved for use with Icom transceivers or charged with Icom chargers. Using third-party or counterfeit battery packs or chargers may cause smoke, fire, or cause the battery to burst.

⚠ **WARNING! NEVER** hold the transceiver so that the antenna is very close to, or touching exposed parts of the body, especially the face or eyes, while transmitting. The transceiver will perform best if the microphone is 5 to 10 cm away from the lips and the transceiver is vertical.

⚠ **WARNING! NEVER** operate the transceiver with a headset or other audio accessories at high volume levels. The continuous high volume operation may cause a ringing in your ears. If you experience the ringing, reduce the volume level or discontinue use.

⚠ **WARNING! NEVER** operate the transceiver while driving a vehicle. Safe driving requires your full attention—anything less may result in an accident.

CAUTION: MAKE SURE the flexible antenna, battery pack, and jack cover are securely attached to the transceiver, and that the antenna and battery pack are dry before attachment. Exposing the inside of the transceiver to dust or water will result in serious damage to the transceiver.

DO NOT operate the transceiver near unshielded electrical blasting caps or in an explosive atmosphere.

DO NOT push [PTT] when you do not actually intend to transmit.

DO NOT operate or place the transceiver in direct sunlight or in areas with temperatures below -25°C or above $+55^{\circ}\text{C}$.

DO NOT modify the transceiver. The specifications may change and then not comply with the requirements of a corresponded regulation. The transceiver warranty does not cover any problems caused by unauthorized modification.

DO NOT use harsh solvents such as benzine or alcohol when cleaning, as they will damage the transceiver surfaces.

BE CAREFUL! The transceiver will become hot when operating it continuously for long periods of time.

KEEP the transceiver away from heavy rain, and never immerse it in the water. The transceiver meets IP54* requirements for dust-protection and splash resistance. However, once the transceiver has been dropped, dust-protection and splash resistance cannot be guaranteed because of possible damage to the transceiver's case or the waterproof seal.

* Only when the battery pack/case and jack cover are attached.

MAKE SURE to turn OFF the transceiver before connecting or disconnecting the supplied or optional accessory.

TABLE OF CONTENTS

FOREWORD	i
EXPLICIT DEFINITIONS	i
VOICE CODING TECHNOLOGY	ii
PRECAUTIONS	iii, iv
1 ACCESSORIES	1–4
■ Supplied accessories	1
■ Accessory attachments	1
2 PANEL DESCRIPTION	5–13
■ Front, top and side panels	5
■ LED indicator	7
■ Programmable function keys	10
3 BASIC OPERATION	14–26
■ Turning ON the power	14
■ Channel selection	15
■ Call procedure	16
■ Receiving and transmitting	17
■ Setting the microphone gain	20
■ Setting the squelch level	21
■ Setting the Beep level	22
■ Setting the Ringer level	23
■ Output power level selection	24
■ Priority A channel selection	24
■ Lone Worker Emergency Call	25
■ Emergency Call	26

4	dPMR OPERATION	27–32
■	dPMR operation	27
■	Receiving a call	28
■	Transmitting a call	30
■	Position data transmission	32
■	Status message transmission	32
■	Scrambler function	32
5	BATTERY CHARGING	33–43
■	Caution (for the BP-264 Ni-MH BATTERY)	33
■	Caution (for the BP-265 Li-ion BATTERY)	35
■	Battery chargers	38
6	BATTERY CASE	44
■	Optional battery case (BP-263)	44
7	OPTIONS	45–50
■	VOX function	48
8	INFORMATION	51
■	Country code list	51
■	Disposal	52

1 ACCESSORIES

■ Supplied accessories

The following accessories are supplied with the transceiver.

Battery pack*

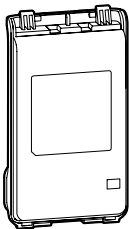

Flexible antenna
(This illustration is for the VHF type.)

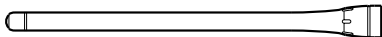

Battery charger*

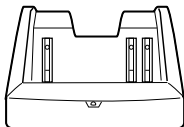

Power adapter*

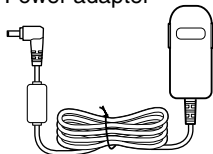

Belt clip*



Jack cover
(with screws)

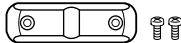

* Not supplied, or the shape is different, depending on the version.

■ Accessory attachments

◇ Flexible antenna

Connect the flexible antenna to the antenna connector.

CAUTION:

- **NEVER** carry the transceiver by holding the antenna.
- **DO NOT** connect the antenna other than listed above.
- Transmitting without an antenna will damage the transceiver.

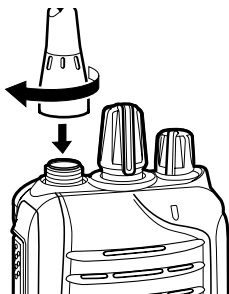

◇ Belt clip

To attach the belt clip:

- ➔ Slide the belt clip in the direction of the arrow until the belt clip locks in place, and makes a 'click' sound.

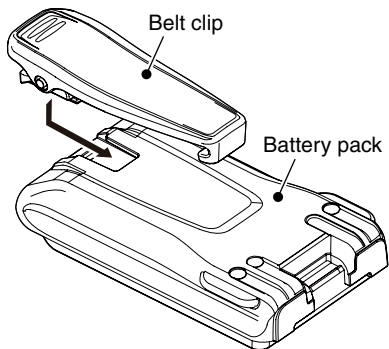

To detach the belt clip:

- ① Remove the battery pack from the transceiver, if it is attached. (p. 3)
- ② Lift the tab up (①), and slide the belt clip in the direction of the arrow (②).

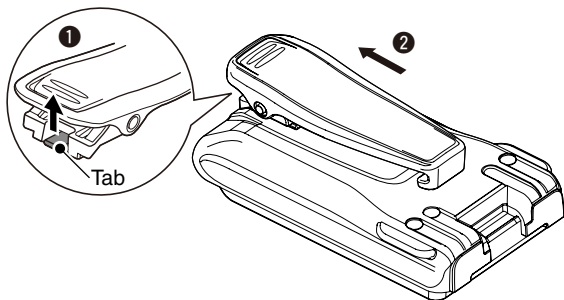

1 ACCESSORIES

◇ Battery pack or case

To attach the battery pack or case:

- ① Fit the battery pack/case in the direction of the arrow, then close it.
- ② Hook the latch until it makes a 'click' sound.

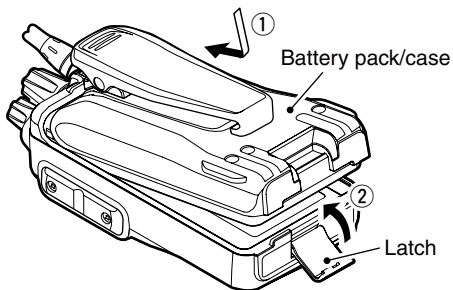

To remove the battery pack/case:

/// **Be careful!** The latch is tightly locked, so use caution when releasing it. **DO NOT** use your finger nail. Use the edge of a coin or screwdriver tip to carefully release it.

- ① Unhook the latch.
- ② Lift up the battery pack/case in the direction of the arrow.

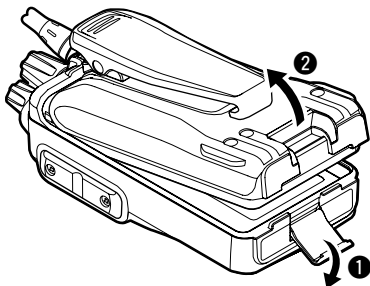

NEVER remove or attach the battery pack/case when the transceiver is wet or soiled. This may result in water or dust getting into the transceiver, battery pack/case, and may result in them being damaged.

NOTE: Keep the battery pack terminals clean. It's a good idea to occasionally clean them.

◇ Jack cover

Attach the jack cover when the optional equipment is not used.

To attach the jack cover:

- ① Attach the jack cover to the [SP MIC] jack.
- ② Tighten the screws.

To detach the jack cover:

- ① Remove the screws with a phillips screwdriver.
- ② Detach the jack cover to connect the optional equipment.

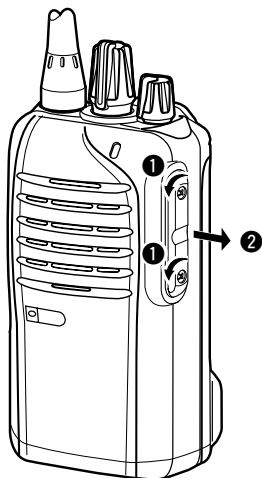
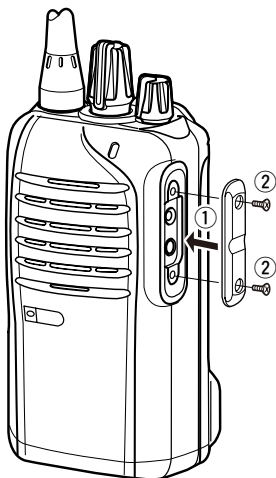

2 PANEL DESCRIPTION

■ Front, top and side panels

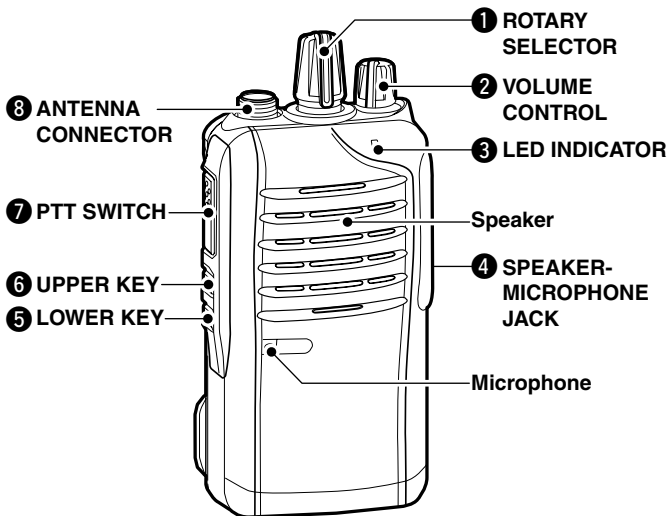

1 ROTARY SELECTOR

Rotate to select the pre-programmed memory channels or scan lists, depending on the pre-programming.

2 VOLUME CONTROL [VOL]

Rotate to turn the power ON or OFF, and adjust the audio level.

3 LED INDICATOR (pp. 7–9)

- ➔ Lights red* while transmitting.

*When the optional battery case is attached, the LED indicator lights orange.

- ➔ Lights green while receiving a signal, or when the squelch is open.
- ➔ Lights/blinks orange when the matched 2/5-tone code is received, depending on the presetting.

See pages 7–9 for details.

4 SPEAKER-MICROPHONE JACK [SP MIC]

Connect the optional speaker-microphone or VOX adapter cable.



Jack cover

NOTE: Attach the jack cover when the optional equipment is not used. (p. 4)

5 LOWER KEY [Lower]**6 UPPER KEY [Upper]**

The desired function can be assigned by your dealer. (p. 10)

7 PTT SWITCH [PTT]

Hold down to transmit; release to receive.

8 ANTENNA CONNECTOR

Connect the antenna.

■ LED indicator

The LED indicator indicates the status of various parameters of the transceiver as follows;
(Reference: R=Red, G=Green, O=Orange)



- TX: Lights Red while transmitting a signal.

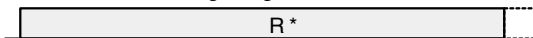

- RX busy: In the Analog CH, lights Green while in the noise squelch opens. In the Digital CH or Mixed CH, lights Green while detecting a frame synchronization.

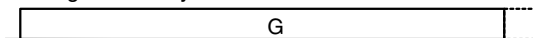

- Call LED: Turns ON while receiving a matched 2/5-tone, or receiving Status or SDM call.



- Call LED: Blinks while receiving a matched 2/5-tone, or receiving Status or SDM call.



- Call LED: Blinks while waiting an acknowledgement.



- Success: Blinks slowly when your call was successful.

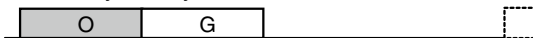

- Call error: Blinks slowly when your call failed, or it was refused.



* Lights (or blinks) orange when the optional battery case is attached.

- Audible: Blinks slowly while in the audible mode after an acknowledgement is received.



- Fast/Slow scan or voting: Blinks when the Fast/Slow scan or voting is activated.

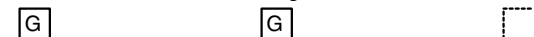

- Low Battery 1: You should charge the battery. (Slowly blinks.)

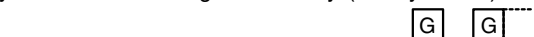

- Low Battery 2: You must charge the battery. (Fast blinks.)



- TX low Battery 1: Low Battery was detected during TX mode.



- TX low Battery 2: Very Low Battery was detected during TX mode.



- Channel Error: Blinks when a non-programmed channel is selected.



- Power ON: Blinks at the transceiver starts up.



- TX inhibit: While in the TX inhibit mode such as the TOT or Lock-out function is activated.



* Lights (or blinks) orange when the optional battery case is attached.

2 PANEL DESCRIPTION

■ LED indicator (Continued)

- Emergency: Blinks when an Emergency call was received (Status or SDM call).

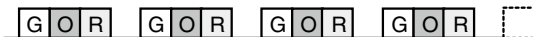

- Emergency Locator Ringer Siren:
Blinks while in the Emergency locator, Ringer or Siren is activated.



■ Programmable function keys

The following functions can be assigned to the [Upper] and [Lower] programmable function keys.

Consult your Icom dealer or system operator for details concerning your transceiver's programming.

SCAN

Push to start and cancel the scanning operation.

- When the scan started with the Power ON Scan or Auto Scan function, push to pause the scanning operation. The paused scan resumes after the specified time period has passed.

PRIORITY A CHANNEL, PRIORITY B CHANNEL

Push to select the Priority A or Priority B channel.

PRIORITY A CHANNEL (REWRITE),

PRIORITY B CHANNEL (REWRITE)

- Push to select the Priority A or Priority B channel.
- Hold down [Prio A (Rewrite)] or [Prio B (Rewrite)] for 1 second to assign the operating channel to Priority A or Priority B channel, respectively.

MEMORY CHANNELS 1, 2, 3, 4

Push to directly select memory channel 1, 2, 3 or 4, if programmed. Consult your dealer for details.

LONE WORKER (p. 25)

- Hold down to turn ON the Lone Worker function.
- Push to turn OFF the Lone Worker function.
 - When the Lone Worker function is turned ON, and no operation is performed for the specified time period, the Emergency function is automatically turned ON.

2 PANEL DESCRIPTION

■ Programmed function keys (Continued)

MONITOR, MONITOR (AUDIBLE)

- Push to turn the CTCSS (DTCS) or 2/5-tone squelch Mute ON or OFF.
 - Only during LMR operation, push to open any squelch functions, or deactivate any mute functions.
 - Only during PMR operation, push to activate one or two of the following functions* on each channel.
 - Hold down to un-mute the channel (Audible mode).
 - Push to mute the channel (Inaudible mode).
 - Push to send a 'reset code' after the communication is finished.
- *Ask your dealer for details.

 **NOTE:** The un-mute condition may automatically return to the mute condition, after a specified time period.

- Depending on the presetting, holding down this key for 1 second cancels a scan.

LOCK

Hold down to electronically lock all programmable keys except [Moni(Audi)], [Call] (including Call A and Call B), [Emergency], [Surveillance] and [Lone Worker].

HIGH/LOW (p. 24)

Select the transmit output power level temporarily or permanently, depending on the presetting.

- Ask your dealer for the output power level for each selection.

TALK AROUND

- Hold down to turn ON the Talk Around function.
- Push to turn OFF the Talk Around function.
 - The Talk Around function equalizes the transmit frequency to the receive frequency for transceiver-to-transceiver communication.

DTMF AUTODIAL

Push to transmit a programmed DTMF code.

WIDE/NARROW

Push to toggle the IF bandwidth between Wide, Mid* or Narrow.

* Depending on the presetting, Mid channel width may not be selectable. Ask your dealer for details.

CALL, CALL A, CALL B

Push to transmit a 2/5-tone code.

- Tone call transmission may be necessary before you call another station, depending on your signalling system.
- [Call A] and/or [Call B] keys may be available when your system employs selective 'Individual/Group' calls. Ask your dealer which call is assigned to each key.

EMERGENCY

Hold down for specified time period to transmit an emergency call.

- The emergency call transmits with beeps, and the LED lights red.
- The transceiver can transmit an emergency call without the beep sounding and the LED indicator lighting. Ask your dealer for details.
- If you want to cancel the emergency call, hold down the key again before transmitting the call.
- The emergency call is transmitted one time only, or repeatedly until receiving an acknowledgement signal, or until the power is turned OFF. When a matched 5-tone code signal is received, the emergency function can be cancelled depending on the presetting. (PMR operation only)

SURVEILLANCE

- ➡ Hold down to turn ON the Surveillance function.
- ➡ Push to turn OFF the Surveillance function.
 - When this function is turned ON, the beep is not heard and the LED does not light when a signal is received, or a key is pushed.

2 PANEL DESCRIPTION

■ LED indicator (Continued)

SIREN

Hold down for 1 second to emit a siren sound.

This function can be used for situations other than an emergency alert, such as a security alarm for example.

The transceiver emits the siren sound until the power is turned OFF.

SCRAMBLER

- Hold down to turn ON the Voice Scrambler function while operating in the digital mode.
- Push to turn OFF the Voice Scrambler function.

ANNOUNCE

Push to turn the Channel Announce function ON or OFF.

- When this function is turned ON, the transceiver announces the position of [ROTARY SELECTOR] between 1 and 16 when rotating [ROTARY SELECTOR] to a desired scale.

BASIC OPERATION 3

■ Turning ON the power

▨ Prior to using the transceiver for the first time, the battery pack must be fully charged for optimum life and operation. (p. 33)

➔ Rotate [VOL] to turn ON the power.

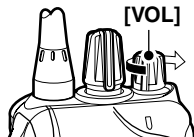

◇ Battery type selection

The battery type must be selected according to the battery pack or case when it is changed, but only the first time it is used.

Check the battery type before you begin the selection procedure.

One to three beep(s) sound in sequence, so you must repeat the steps until the number of beeps matches your battery type.

For example, if your battery type is a Li-ion battery pack, you must repeat the procedure until one beep is heard.

- ① Set [ROTARY SELECTOR] to any channel other than Channel 16.
- ② Rotate [VOL] to turn OFF the transceiver's power.
- ③ While holding down [PTT], rotate [VOL] to turn ON the power.
 - You should hold [PTT] until the beep sounds. (It takes approximately 5 second.)
 - One beep sounds when the Li-ion battery is selected.
 - Two beeps sound when the battery case is selected.
 - Three beeps sound when the Ni-MH battery is selected.
- ④ After the beep sounds, release [PTT].
- ⑤ Repeat steps ② to ④ until you select the attached battery type.

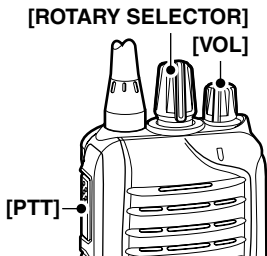

▨ **NOTE:** This operation may not be available, depending on the presetting. Ask your dealer for details.

■ Channel selection

Several types of channel selections are available. Methods may differ, depending on the presetting.

To select a desired operating channel, do one of the following.

- Rotate [ROTARY SELECTOR].
- Push one of memory channel keys, [MR-CH 1] to [MR-CH 4].
- Push one of these keys, [Prio A], [Prio B], [Prio A (Rewrite)] and [Prio B (Rewrite)].

AUTOMATIC SCAN TYPE:

Selecting a channel is not necessary for this type. When turning ON the power, the transceiver automatically starts scanning. Scanning stops when a signal is detected.

/// **NOTE:** If the Move to Priority A channel at Power ON function (p. 24) is turned ON, the transceiver does not start scanning at power ON.

◇ **Voting Operation**

The transceiver automatically starts scanning when a zone, specified for the voting operation, is selected.

The voting scan detects the signal of the repeater and automatically selects the strongest station.

■ Call procedure

When your system employs tone signalling (excluding CTCSS and DTCS), the tone call procedure may be necessary prior to voice transmission. The tone signalling that is employed in the transceiver may be a selective calling system, which allows you to call only specific station(s), and prevent unwanted stations from contacting you.

- ① Select a desired TX code channel or 2/5-tone code, according to your System Operator's instructions.
 - This may not be necessary, depending on programming.
- ② Push [Call] (assigned to one of the dealer programmable keys.) (p. 12)
- ③ After transmitting a 2/5-tone code, the remainder of your communication can be carried out normally.

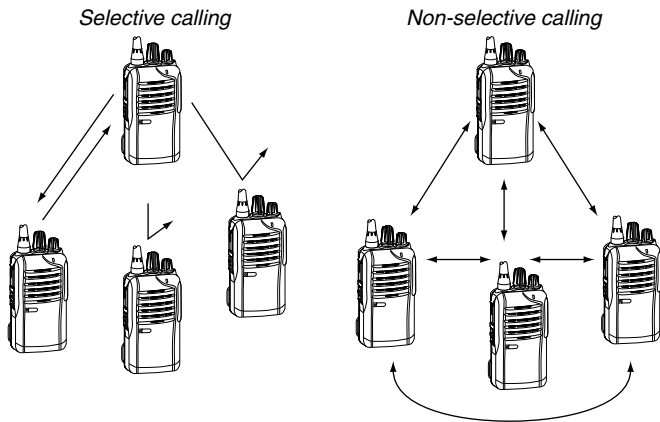

■ Receiving and transmitting

 **CAUTION:** Transmitting without an antenna will damage the transceiver. See page 1 for antenna attachment.

Receiving:

- ① Rotate [VOL] to turn ON the power.
- ② Rotate [ROTARY SELECTOR], or push one of the memory channel keys, [MR-CH 1] to [MR-CH 4], to select a channel.
- ③ When receiving a call, adjust the audio output to a comfortable listening level.

 **NOTE:** When a matched RX code signal is received, audio from the microphone is automatically transmitted for a specified time period.*

 * Depending on the presetting. Ask your dealer for details.

Transmitting:

Wait for the channel to become clear to avoid interference.

- ① While holding down [PTT], speak into the microphone at a normal voice level.
- ② Release [PTT] to return to receive.

 **IMPORTANT:** To maximize the readability of your signal;

1. Pause briefly after pushing [PTT].
2. Hold the microphone 5 to 10 cm (2 to 4 inches) from your mouth, then speak into the microphone at a normal voice level.

◇ Transmitting notes

• Transmit inhibit function

The transceiver has several inhibit functions, which restrict transmission under the following conditions:

- The channel is muted. (PMR operation only)
- The channel is busy.
- A signal with the un-matched (or matched) CTCSS (or DTCS) tone is received.
- The selected channel is a 'receive only' channel.

• Time-out timer

After continuously transmitting longer than the pre-programmed time period, the time-out timer activates, and stops further transmitting.

• Penalty timer

Once the time-out timer activates, transmitting is further inhibited for a time period determined by the penalty timer.

• PTTID call

The transceiver automatically sends the ID code (5-tone, DTMF, BIIS or dPMR operations) when [PTT] is pushed (beginning of the transmission) and/or released (end of transmission), depending on the presetting.

3 BASIC OPERATION

◇ **DTMF transmission**

If the transceiver has [DTMF Autodial] assigned to it, the automatic DTMF transmission function is usable.

➡ Push [DTMF Autodial] to transmit the DTMF code.

◇ **Receiving a Stun, Kill and Revive command**

The dispatcher can send a signal that will stun, kill or revive your transceiver.

When the Stun command is received, a beep sounds*, and the transceiver becomes unusable. Receiving a Revive command is necessary to operate the transceiver again in this case.

When the Kill command is received, a beep sounds*, and the transceiver becomes unusable (the transceiver switches to the cloning required condition). Cloning the transceiver is necessary to operate the transceiver again in this case.

* Depending on the presetting. Ask your dealer for details.

■ Setting the microphone gain

Adjusts the microphone gain.

- ① Rotate [VOL] to turn the transceiver power OFF.
- ② Set [ROTARY SELECTOR] to Channel 16.
- ③ While holding down [Upper], rotate [VOL] to turn ON the power and enter the microphone gain adjustment mode.
- ④ Push [Upper] to increase, or push [Lower] to decrease the microphone gain.

- The adjustable range is 1 (minimum) to 4 (maximum).
- A beep sounds after pushing [Upper] or [Lower].

An error beep sounds if you try to decrease more than 1 or try to increase more than 4.

Therefore, you can determine the current level setting by the type of beep that sounds.

- ⑤ Rotate [VOL] to turn the power OFF, then ON again to exit the microphone gain adjustment mode.

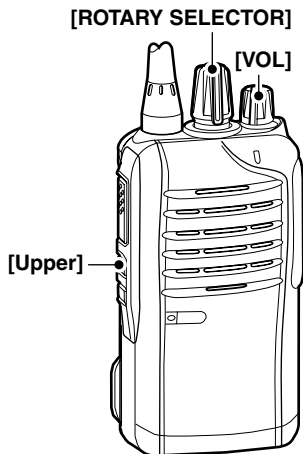

NOTE:

- This operation may not be available, depending on the presetting. Ask your dealer for details.
- When using the VOX function, we recommend setting the microphone gain to 3. However, you can adjust it to suit your operating environment (including your headset performance).

■ Setting the squelch level

The squelch circuit mutes the received audio signal, depending on the signal strength.

- ① Rotate [VOL] to turn the transceiver power OFF.
- ② Set [ROTARY SELECTOR] to any channel other than Channel 16.
- ③ While holding down [Upper], rotate [VOL] to turn ON the power and enter the squelch level adjustment mode.
- ④ Push [Upper] to increase the squelch level (tight squelch), or push [Lower] to decrease the squelch level (loose squelch).
 - The adjustable range is 0 (loose squelch) to 9 (tight squelch).
 - A beep sounds after pushing [Upper] or [Lower].

An error beep sounds if you try to decrease more than 0 or try to increase more than 9.

Therefore, you can determine the current level setting by the type of beep that sounds.

- ⑤ Rotate [VOL] to turn the power OFF, then ON again to exit the squelch level adjustment mode.

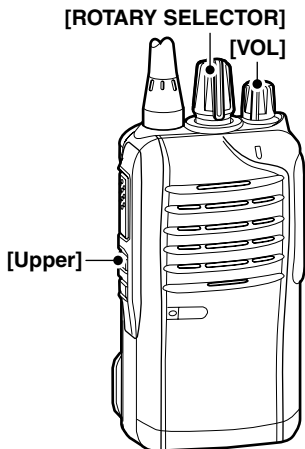

NOTE: This operation may not be available, depending on the presetting. Ask your dealer for details.

■ Setting the Beep level

The beep function can be turned ON or OFF, and its level can be adjusted between 1 and 5, or 1 (linked) and 5 (linked). When a Linked option is selected, the beep level is adjustable with [VOL].

- ① Rotate [VOL] to turn the transceiver power OFF.
- ② Set [ROTARY SELECTOR] to any channel other than Channel 16.
- ③ While holding down [Lower], rotate [VOL] to turn ON the power and enter the beep level adjustment mode.
- ④ Push [Upper] to change the beep level, or push [Lower] to turn the beep function ON or OFF.
 - The adjustable range is 1 to 5 or 1 (Linked) to 5 (Linked).
 - If the level is set on 1 to 4 or 1 (Linked) to 4 (Linked), pushing [Upper] increases the level.
 - If the level is 5 or 5 (Linked), 1 (Linked) or 1 is selected after pushing [Upper], respectively.
 - A beep sounds after pushing [Upper]. Therefore, you can determine the current level setting by the type of beep that sounds.
 - One beep sounds when the beep function is turned ON after pushing [Lower].
- ⑤ Rotate [VOL] to turn the power OFF, then ON again to exit the beep level adjustment mode.

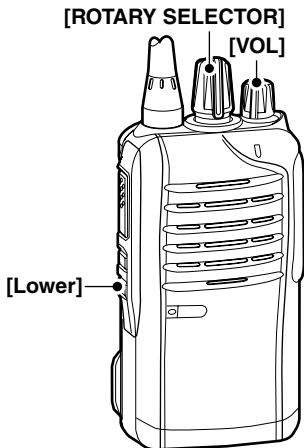

NOTE: This operation may not be available, depending on the presetting. Ask your dealer for details.

■ Setting the Ringer level

The Ringer level can be adjusted between 1 and 5, or 1 (Linked) and 5 (Linked). When a Linked option is selected, the Ringer level is adjustable with [VOL].

- ① Rotate [VOL] to turn the transceiver power OFF.
- ② Set [ROTARY SELECTOR] to Channel 16.
- ③ While holding down [Lower], rotate [VOL] to turn ON the power and enter the Ringer level adjustment mode.
- ④ Push [Upper] to increase, or push [Lower] to decrease the Ringer level.
 - The adjustable range is 1 to 5 or 1 (Linked) to 5 (Linked).
 - If the level is set on 5 or 5 (Linked), pushing [Upper] selects 1 (Linked) or 1, respectively. If the level is 1 or 1 (Linked), pushing [Lower] selects 5 (Linked) or 5, respectively.
 - A beep sounds after pushing [Upper] or [Lower]. Therefore, you can determine the current level setting by the type of beep that sounds.
- ⑤ Rotate [VOL] to turn the power OFF, then ON again to exit the beep level adjustment mode.

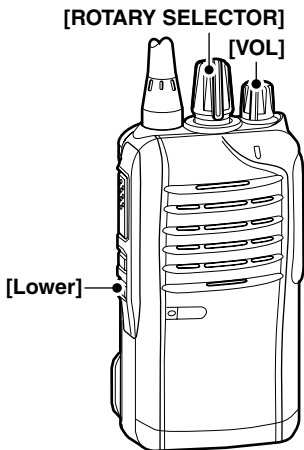

NOTE: This operation may not be available, depending on the presetting. Ask your dealer for details.

■ Output power level selection

If the transceiver has [High/Low] assigned to it, the transmit output power level can be selected, depending on the presetting.

When the battery case is selected as the battery type, or the battery voltage drops to a low power level and the LED indicator status is “Low Battery 2,” the output power automatically switches to “Low 1.” (pp. 8, 14)

- Push [High/Low] to select the transmit output power level.
 - One beep sounds when “Low 1” is selected.
 - Two beeps sound when “Low 2” is selected.
 - Three beeps sound when “High” is selected.

■ Priority A channel selection

When one of the following operations is performed, the transceiver automatically selects the Priority A channel.

- Turning the power ON
The Priority A channel is selected each time the transceiver power is turned ON.
- Auto reset
The Priority A channel is selected when the Auto Reset timer ends.

■ Lone Worker Emergency Call

When the Lone Worker function is turned ON, and no operation is performed for the specified time period*, the transceiver enters the emergency mode, and then the countdown for the emergency call transmission starts.

After the specified time period* has passed, an emergency call is automatically transmitted once, or repeatedly*.

If someone operates the transceiver before the call is transmitted, the transceiver exits the emergency mode, and the emergency call is cancelled.

* Depending on the presetting. Ask your dealer for details.

- ① Hold down [Lone Worker] to turn ON the Lone Worker function.
- ② Push [Lone Worker] to turn OFF the Lone Worker function.

■ Emergency Call

When [Emergency] is held down for the specified time period*, the emergency signal is transmitted once, or repeatedly, on the specified emergency channel.

A repeat emergency signal is automatically transmitted until you turn the power OFF.

Depending on the pre-programmed settings, receiving a matching 5-tone code cancels the transmission.

When no emergency channel is specified, the signal is transmitted on the previously selected channel.

If you want to cancel the emergency call, hold down [Emergency] again before transmitting the call.

If your transceiver is programmed for Silent operation, you can transmit an Emergency call without the beep sounding and the LED indicator lighting.

 **IMPORTANT:** It is recommended to set an emergency channel individually to provide the certain emergency call operation.

◇ NOTES

Depending on the presetting, the following functions are automatically activated. Ask your dealer for details.

• Auto TX function

After the emergency call transmission, audio from the microphone is automatically transmitted for a specified time period.*

• Auto RX function

After the emergency call transmission, the transceiver stands by in the audible mode for the specified time period.*

* Depending on the presetting. Ask your dealer for details.

4 dPMR OPERATION

■ dPMR operation

The transceiver provides digital Private Mobile Radio (dPMR) operation that meets the 6.25 kHz bandwidth requirements for narrow band operation. This increases the efficiency of channel allocation and use of the spectrum.

/// NOTE: During dPMR operation, BIIS 1200 operation is disabled.

■ Receiving a call

◇ Receiving an Individual call

- ① When an Individual call is received:
 - The transceiver will automatically transmit the acknowledgment.
 - The LED indicator blinks orange.
 - Beeps sound and the mute is released.
- ② Hold down [PTT], then speak into the microphone.
- ③ Release [PTT] to receive a response.
- ④ After the communication is finished, push [Clear] to send a 'Disconnect' signal to terminate the connection.

/// NOTE: The LED indicator or Beeps may differ, depending on the presetting. Ask your dealer for details.

◇ Receiving a Group call

- ① When a Group call is received:
 - The LED indicator blinks orange.
 - Beeps sound and the mute is released.
- ② Hold down [PTT], then speak into the microphone.
 **NOTE:** Only one station is allowed to speak at the same time.
- ③ Release [PTT] to receive a response.
- ④ After the communication is finished, push [Clear] to send a 'Disconnect' signal to terminate the connection.

 **NOTE:** The LED indicator or Beeps may differ, depending on the presetting. Ask your dealer for details.

◇ Receiving a Stun, Kill or Revive

If an individual call with Stun or Kill command is received, the transceiver will automatically transmit the acknowledgement, and then you cannot receive* or transmit.

* Depending on the received Stun command setting.

- When a Stun command is received;
 - The transceiver cannot be operated until the individual call with Revive command is received or until the data cloning is performed.
 - Even if [ROTARY SELECTOR] is changed, the transceiver will keep the same channel as the Stun command is received.
- When a Kill command is received;
 - The LED indicator alternately blinks red and green.
 - The transceiver cannot be operated until the data cloning is performed. Ask your dealer for details.

 **NOTE:** Depending on the presetting, the transceiver ignores the Stun, Revive and Kill commands, which are from a non-specified station.

■ Receiving a call (Continued)

◇ Receiving a Status Polling call

If a Status Polling call is received, the transceiver will automatically transmit its current status.

◇ Receiving an Ambience Listening call

If an Individual call with an Ambience Listening command is received from a specified station, the transceiver will automatically transmit its microphone audio.

 **NOTE:** If the transceiver receives an Ambience Listening command from a station other than the specified one, the call will be ignored, and the transceiver will not transmit its microphone audio.

◇ Receiving an Emergency call

- ① When an Emergency call is received:
 - The transceiver will automatically transmit the acknowledgment.
 - The LED indicator blinks orange.
 - Beeps sound and the mute is released.
- ② Push [Clear] to return to the stand-by mode.

◇ Talk back function

The Talk Back function allows you to select the same call mode (Analog or Digital) as the received call.

 **NOTE:** When this function is not activated, the transceiver always transmits analog signals on “Mixed-Analog” channels, and digital signals on “Mixed-Digital” channels.

- On these channels, the transceiver can receive both analog and digital signals, regardless of the Talk Back function.

■ Transmitting a call

dPMR operation allows you to make a call to a specific station (Individual call) or to a particular group (Talkgroup call). Other digital mode transceivers on the channel will not receive a call that does not match their individual or talkgroup ID and/or CC.

4

◇ Transmitting a Voice call

- ① Rotate [ROTARY SELECTOR], or push one of the memory channel keys, [MR-CH 1] to [MR-CH 4], to select a desired channel, Individual ID or Talkgroup ID, depending on the presetting.
- ② Push [PTT] or [Call] to make a Voice call.
 - The LED indicator lights red while transmitting.
 - The LED indicator fast blinks orange.
 - After an acknowledgement is received, the LED indicator slowly blinks orange in the audible mode.
Or it goes OFF when no acknowledgement is received.
- ③ Hold down [PTT], then speak into the microphone.
 - The LED indicator lights red while transmitting.
- ④ Release [PTT] to receive a response.
- ⑤ After the communication is finished, push [Clear] to send a 'Disconnect' signal to terminate the connection.

■ Transmitting a call (Continued)

◇ **Transmitting an Emergency call**

When [Emergency] is held down for the specified time period, the emergency signal (digital command) is transmitted once or repeatedly* on the specified emergency channel. When no emergency channel is specified, the signal is transmitted on the operating channel.

* When the Repeat Cancel function is ON, the transceiver cancels repeating after receiving an acknowledgement.

When the Repeat Cancel function is OFF, the transceiver repeats calling according to the number of repeat cycles, even after receiving an acknowledgement.

Individual or Talkgroup call types of emergency calls can be pre-fixed. If the call type is not pre-fixed, the default or selected call type is used.

If you want to cancel the emergency call, hold down [Emergency] again before transmitting the call.

If your transceiver is programmed for Silent operation, you can transmit an Emergency call without the beep sounding and the LED indicator lighting.

The transceiver can also be programmed to keep the microphone open during an emergency call, allowing monitoring of the situation.

Ask your dealer for details.

/// IMPORTANT: It is recommended to set an emergency channel individually to provide the certain emergency call operation.

/// NOTE: The Digital Request Ack function is activated, the transceiver transmits the emergency call with the request to send back an acknowledgment.

■ Position data transmission

When an optional HM-171GP or any other GPS receiver is connected to the transceiver, the position (longitude and latitude) data can automatically be transmitted when:

- When [PTT] is released.
 - Set the 'Send with Logoff' item as 'Enable.'
- After sending a Status Call.
 - Set the 'Send with Status Call' item as 'Enable.'
- After sending an SDM.
 - Set the 'Send with SDM Call' item as 'Enable.'
- After sending an Emergency Call.
 - Set the 'Send with Emergency' item as 'Enable.'

Ask your dealer or system operator for connection details.

■ Status message transmission

The status message can automatically be transmitted.

The status message is transmitted when the transceiver is turned ON or OFF.

- Select a status message to be transmitted in 'Power ON Status' or 'Power OFF Status' item, respectively.
- Select a target station ID in 'Power Status ID'.

■ Scrambler function

The voice scrambler function provides private communication between stations while operating in the digital mode.

Hold down [Scrambler] to turn ON the Scrambler function.

- Push [Scrambler] to turn OFF the Scrambler function.

5 BATTERY CHARGING

■ Caution (for the BP-264 Ni-MH BATTERY)

⚠ **DANGER! KEEP** battery packs away from fire. Fire or heat may cause them to rupture or explode. Dispose of an used battery pack in accordance with local regulations.

⚠ **DANGER! NEVER** immerse the battery pack in water. If the battery pack becomes wet, be sure to wipe it dry **BEFORE** attaching it to the transceiver.

⚠ **WARNING! NEVER** charge the transceiver during a lightning storm. It may result in an electric shock, cause a fire or damage the transceiver. Always disconnect the power adapter before a storm.

CAUTION: Always use the battery within the specified temperature range, -5°C to $+55^{\circ}\text{C}$. Using the battery out of its specified temperature range will reduce the battery's performance and battery life.

CAUTION: Shorter battery life could occur if the battery is left completely discharged, or in an excessive temperature environment (above $+60^{\circ}\text{C}$) for an extended period of time. If the battery must be left unused for a long time, it must be detached from the transceiver after charging. Keep it safely in a cool dry place at the following temperature range:

-20°C to $+45^{\circ}\text{C}$ (up to a month)

-20°C to $+35^{\circ}\text{C}$ (up to six months)

-20°C to $+25^{\circ}\text{C}$ (up to a year*)

* We recommend charging the battery pack every 6 months.

Clean the battery terminals to avoid rust or misscontact.

Keep the battery terminals clean. It's a good idea to clean the battery terminals once a week.

If your Ni-MH battery pack seems to have no capacity, even after being charged, completely discharge it by leaving the power ON overnight. Then, fully charge the battery pack again. If the battery pack still does not retain a charge (or only very little charge), a new battery pack must be purchased. (p. 45)

Prior to using the transceiver for the first time, the battery pack must be fully charged for optimum life and operation.

- Recommended temperature range for charging:
between +10°C and +40°C (rapid charge: with BC-191) or
between 0°C and +45°C (regular charge: with BC-192)
- Use the supplied charger or optional charger (BC-191 for rapid charging, BC-192 for regular charging) only. **NEVER** use other manufacturers' chargers.

The battery pack contains a rechargeable battery.

Charge the battery pack before first operating the transceiver, or when the battery pack becomes exhausted.

If you want to prolong the battery life, the following points should be observed:

- Avoid over charging. The charging time period by the BC-192 should be less than 48 hours.
- Use the battery pack until it becomes almost completely exhausted, under normal conditions. We recommend battery charging after transmitting becomes impossible.

■ **Caution** (for the BP-265 Li-ion BATTERY)

Misuse of Li-ion batteries may result in the following hazards: smoke, fire, or the battery may rupture. Misuse can also cause damage to the battery or degradation of battery performance.

◇ **Battery caution**

⚠ **DANGER! DO NOT** hammer or otherwise impact the battery. Do not use the battery if it has been severely impacted or dropped, or if the battery has been subjected to heavy pressure. Battery damage may not be visible on the outside of the case. Even if the surface of the battery does not show cracks or any other damage, the cells inside the battery may rupture or catch fire.

⚠ **DANGER! NEVER** use or leave battery packs in areas with temperatures above +60°C. High temperature buildup in the battery, such as could occur near fires or stoves, inside a sun-heated vehicle, or in direct sunlight for long periods of time may cause the battery to rupture or catch fire. Excessive temperatures may also degrade battery performance or shorten battery life.

⚠ **DANGER! DO NOT** expose the battery to rain, snow, seawater, or any other liquids. Do not charge or use a wet battery. If the battery gets wet, be sure to wipe it dry before using. The battery is not waterproof.

⚠ **DANGER! KEEP** battery packs away from fire. Fire or heat may cause them to rupture or explode. Dispose of an used battery pack in accordance with local regulations.

⚠ **DANGER! NEVER** solder the battery terminals or NEVER modify the battery pack. This may generate heat in the battery, and the battery pack may burst, emit smoke or catch fire.

⚠ **DANGER!** Use the battery only with the transceiver for which it is specified. Never use a battery with any other equipment, or for any purpose that is not specified in this instruction manual.

⚠ **DANGER!** If fluid from inside the battery gets in your eyes, blindness can result. Rinse your eyes with clean water, without rubbing them, and see a doctor immediately.

⚠ **WARNING!** Immediately stop using the battery if it emits an abnormal odor, heats up, or is discolored or deformed. If any of these conditions occur, contact your Icom dealer or distributor.

⚠ **WARNING!** Immediately wash, using clean water, any part of the body that comes into contact with fluid from inside the battery.

⚠ **WARNING! NEVER** put the battery in a microwave oven, high-pressure container, or in an induction heating cooker. This could cause a fire, overheating, or cause the battery to rupture.

CAUTION: Always use the battery within the specified temperature range, -20°C to $+55^{\circ}\text{C}$. Using the battery out of its specified temperature range will reduce the battery's performance and battery life.

CAUTION: Shorter battery life could occur if the battery is left fully charged, completely discharged, or in an excessive temperature environment (above $+50^{\circ}\text{C}$) for an extended period of time. If the battery must be left unused for a long time, it must be detached from the transceiver after discharging.

You may use the battery until the remaining capacity is about half, then keep it safely in a cool dry place within the temperature range as shown below:

- 20°C to $+50^{\circ}\text{C}$ (up to a month)
- 20°C to $+35^{\circ}\text{C}$ (up to three months)
- 20°C to $+20^{\circ}\text{C}$ (up to a year)

5 BATTERY CHARGING

BE SURE to replace the battery pack with a new one approximately five years after manufacturing, even if it still holds a charge. The inside battery material will become weak after a period of time, even with little use. The estimated number of times you can charge the battery is between 300 and 500.

Even when the battery appears to be fully charged, the operating time of the transceiver may become short when:

- Approximately five years have passed since the battery was manufactured.
- The battery has been repeatedly charged.

◇ Charging caution

⚠ **DANGER! NEVER** charge the battery pack in areas with extremely high temperatures, such as near fires or stoves, inside a sun heated car, or in direct sunlight. In such environments, the safety/protection circuit in the battery will activate, causing the battery to stop charging.

⚠ **WARNING! NEVER** charge the transceiver during a lightning storm. It may result in an electric shock, cause a fire or damage the transceiver. Always disconnect the power adapter before a storm.

⚠ **WARNING! DO NOT** charge or leave the battery in the battery charger beyond the specified time for charging. If the battery is not completely charged by the specified time, stop charging and remove the battery from the battery charger. Continuing to charge the battery beyond the specified time limit may cause a fire, overheating, or the battery may rupture.

⚠ **WARNING! NEVER** insert the transceiver (battery attached to the transceiver) into the charger if it is wet or soiled. This could corrode the battery charger terminals or damage the charger. The charger is not waterproof.

CAUTION: DO NOT charge the battery outside of the specified temperature range: BC-193 (+10°C to +40°C). Icom recommends charging the battery at +20°C. The battery may heat up or rupture if charged out of the specified temperature range. Additionally, battery performance or battery life may be reduced.

Battery chargers

◇ Using the BC-191 to rapid charge the BP-264

The BC-191 provides rapid charging of the Ni-MH battery pack (BP-264 only). Never use for any other battery pack.

Charging time period: Approximately 2 hours (for the BP-264)

The following item is additionally required:

- A power adapter (not supplied with some versions) or the DC power cable (OPC-515L/CP-23L).

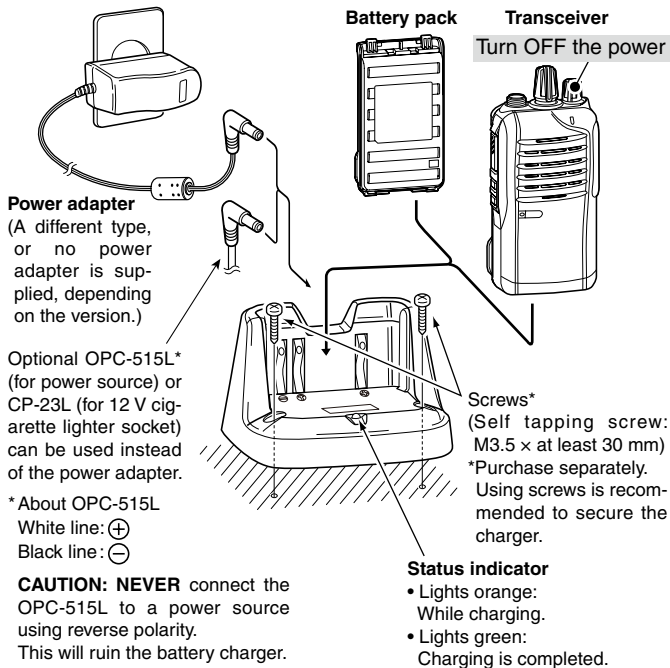

5 BATTERY CHARGING

◇ Using the BC-192 to regular charge the BP-264

The BC-192 provides regular charging of the Ni-MH battery pack (BP-264 only). Never use for any other battery pack.

Charging time period (with BC-147S): Approximately 16 hours (for the BP-264)

The following item is additionally required:

- A power adapter (not supplied with some versions) or the DC power cable (OPC-515L).

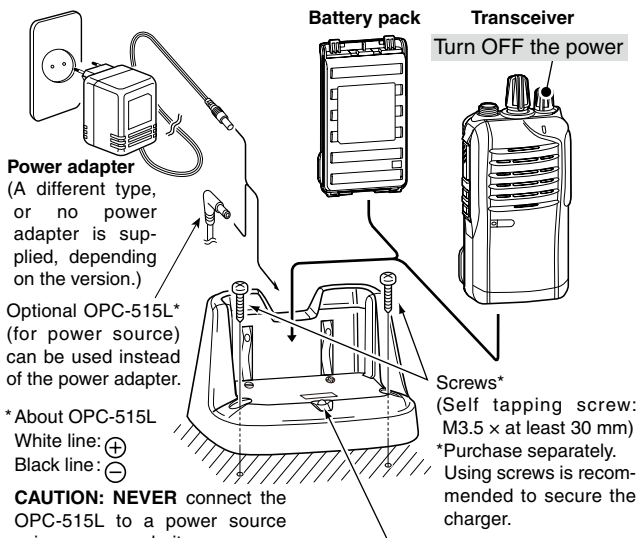

Charging time period differs depending on the input voltage.

12 V	: Approx. 36 hours
13.8 V	: Approx. 21 hours
16 V	: Approx. 16 hours

Status indicator

Lights green while charging.

NOTE:

The status indicator will not go out even after a battery pack is fully charged.

◇ Using the BC-193 to rapid charge the BP-265

The BC-193 provides rapid charging of the Li-ion battery pack (BP-265 only). Never use for any other battery pack.

Charging time period: Approximately 2.5 hours (for the BP-265)

The following item is additionally required:

- A power adapter (not supplied with some versions) or the DC power cable (OPC-515L/CP-23L).

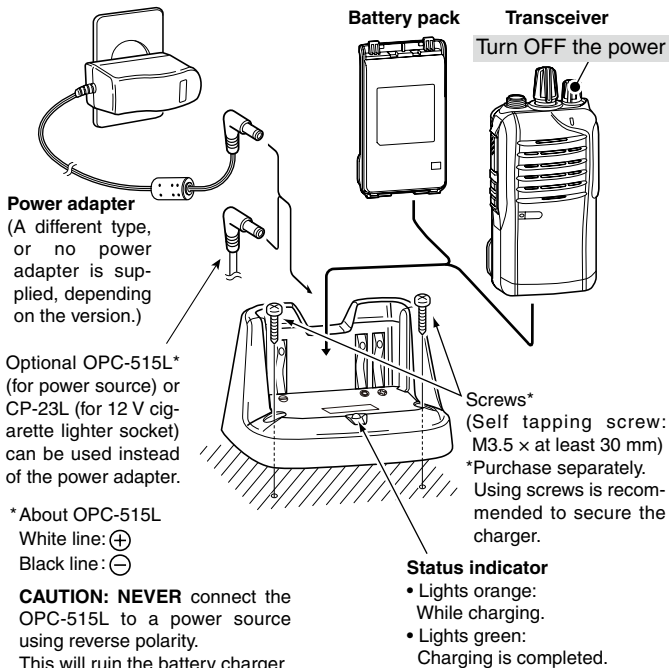

5 BATTERY CHARGING

◇ Using the BC-197 to rapid charge the BP-264 or BP-265

The BC-197 rapidly charges up to six battery packs.

Charging time for BP-264: Approximately 2 hours

Charging time for BP-265: Approximately 2.5 hours

The following additional item is required:

- A power adapter (not supplied with some versions) or the DC power cable (OPC-656)

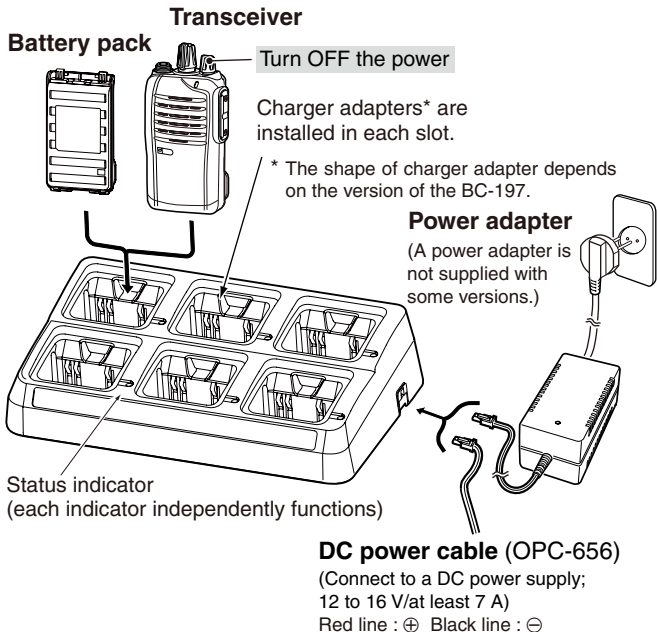

There are two types of BC-197 chargers for the IC-F3102D, IC-F3103D, IC-F4102D or IC-F4103D; one is for Ni-MH batteries, and the other is for Li-ion batteries.

Before you purchase a BC-197, check the type of battery you are using, and then be sure to choose the suitable charger.

5

BC-197 Charger Type	Chargeable Battery
With AD-120* charger adapters	BP-264 Ni-MH battery
With AD-121* charger adapters	BP-265 Li-ion battery

* The type of the charger adapter, AD-120 or AD-121 is printed on the inside bottom of the charger adapter, and the type of battery it holds is printed on the top right corner of the adapter.

5 BATTERY CHARGING

IMPORTANT:

Ensure the tabs on the battery pack are correctly aligned with the guide rails inside the charger.

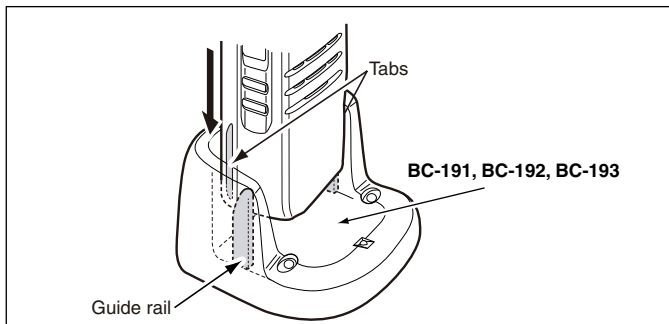

■ Optional battery case (BP-263)

When using the optional battery case, install 6 × AA (LR6) size alkaline batteries, as illustrated below.

- ① Remove the battery case, if it is attached. (pp. 3, 4)
- ② Install 6 × AA (LR6) size alkaline batteries.
 - Install only alkaline batteries.
 - Be sure to observe the correct polarity.

5

6

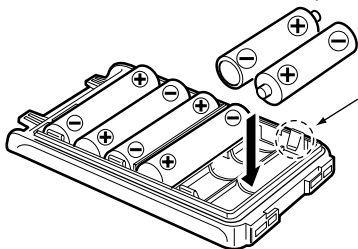

Be careful! The negative terminals of the battery case protrude from the body, so pay attention not to injure your fingers when inserting the batteries.

- ③ Attach the battery case. (pp. 3, 4)

CAUTION:

- When installing batteries, make sure they are all the same brand, type and capacity. Also, do not mix new and old batteries together.
- Keep the battery terminals clean. It's a good idea to clean the battery terminals once a week.
- Never incinerate used battery cells since internal battery gas may cause them to rupture.
- Never expose a detached battery case to water. If the battery case gets wet, be sure to wipe it dry before using it.
- Never use batteries whose insulated cover is damaged.

NOTE: When the optional battery case is attached, the battery type must be selected as “Battery case operation” when turning the transceiver ON. Ask your dealer for details. (p. 14)

7 OPTIONS

◇ BATTERY PACK

Battery pack	Voltage	Capacity	Battery life*1	
BP-263	Battery case for AA (LR6) × 6 alkaline		__*2	
BP-264	7.2 V	1400 mAh (typ.)	VHF	12 hrs.
			UHF	11.3 hrs.
BP-265	7.4 V	1900 mAh (min.) 2000 mAh (typ.)	VHF	17.5 hrs.
			UHF	16.1 hrs.

*1 When the power save function is turned ON, and the operating time is calculated under the following conditions;

TX : RX : standby = 5 : 5 : 90

*2 The average operating time depends on the alkaline cells used.

◇ BELT CLIPS

• **MB-124** BELT CLIP

Exclusive alligator-type belt clip.

◇ CHARGERS

• **BC-191** DESKTOP CHARGER + **BC-123S** AC ADAPTER

For rapid charging of the Ni-MH battery pack. A power adapter is supplied with the charger, depending on the version.

Charging time period: approximately 2 hours for the BP-264.

• **BC-192** DESKTOP CHARGER + **BC-147S** AC ADAPTER

For regular charging of the Ni-MH battery pack. A power adapter is supplied with the charger, depending on the version.

Charging time period: approximately 16 hours for the BP-264.

• **BC-193** DESKTOP CHARGER + **BC-123S** AC ADAPTER

For rapid charging of the Li-ion battery pack. A power adapter is supplied with the charger, depending on the version.

Charging time period: approximately 2.5 hours for the BP-265.

• **BC-197** MULTI-CHARGER

For rapid simultaneously charging of up to six battery packs. A power adapter may be supplied with the charger, depending on the version. There are two types of BC-197 chargers for the IC-F3102D/IC-F3103D/IC-F4102D/IC-F4103D.

BC-197 Charger Type	Chargeable Battery	Charging time
With AD-120*	BP-264 Ni-MH battery	Approx. 2 hrs.
With AD-121*	BP-265 Li-ion battery	Approx. 2.5 hrs.

*Either AD-120 or AD-121 charger adapters are installed in the BC-197, depending on the chargeable battery pack.

◇ **DC POWER CABLES**

• **CP-23L** CIGARETTE LIGHTER CABLE

Allows charging of the battery pack through a 12 V cigarette lighter socket. (For BC-191/BC-193)

• **OPC-515L/OPC-656** DC POWER CABLE

For charging of the battery packs using a 12 V DC power source instead of the power adapter.
(OPC-515L for BC-191/BC-192/BC-193: OPC-656 for BC-197)

◇ **ANTENNAS**

• **FA-SC73US/FA-SC56VS/FA-SC57VS** STUBBY ANTENNAS

FA-SC73US : 450–490 MHz FA-SC56VS : 150–162 MHz
FA-SC57VS : 160–174 MHz

• **FA-SC25U/FA-SC57U/FA-SC72U/**

FA-SC25V/FA-SC55V ANTENNAS

FA-SC25U : 400–430 MHz FA-SC57U : 430–470 MHz
FA-SC72U : 470–520 MHz FA-SC25V : 136–155 MHz
FA-SC55V : 146–174 MHz

• **FA-SC61VC/FA-SC61UC** CUT ANTENNAS

FA-SC61VC : 136–174 MHz FA-SC61UC : 380–520 MHz

• **FA-SC62V/FA-SC63V** HIGH GAIN ANTENNAS

FA-SC62V : 150–160 MHz FA-SC63V : 155–165 MHz

◇ OTHER OPTIONS

- **AD-98FSC** ANTENNA CONNECTOR CONVERTER
Allows you to connect an external antenna with a BNC connector.
- **HM-158L/HM-159L** SPEAKER-MICROPHONE
Combination speaker-microphone that provides convenient operation while hanging the transceiver on your belt.
- **HM-171GP** SPEAKER-MICROPHONE
GPS speaker-microphone for BISS and Digital modes operation.
- **HS-94/HS-95/HS-97** HEADSET + **OPC-2004** PLUG ADAPTER CABLE
HS-94 : Ear hook type
HS-95 : Neck-arm type
HS-97 : Throat microphone
OPC-2004 : Allows you to connect the HS-94/HS-95/HS-97 to the transceiver. After connection, the VOX function can be used.
- **SP-27** TUBE EARPHONE
Provides clear audio in noisy environments.

Some options may not be available in some countries. Please ask your dealer for details.

■ VOX function

The transceiver has a VOX function, which allows you hands-free operation.

An optional headset (HS-94/HS-95/HS-97) and a plug adapter cable (OPC-2004) are additionally required for operation.

- The VOX (voice operated transmission) function starts transmitting when you speak into the microphone, without needing to push the PTT switch; then, automatically returns to receive when you stop speaking.

◇ Optional unit connection

- ① Rotate [VOL] to turn the transceiver power OFF.
- ② Remove the jack cover. (p. 4)
- ③ Connect the optional headset (HS-94, HS-95 or HS-97) and OPC-2004 as described below.

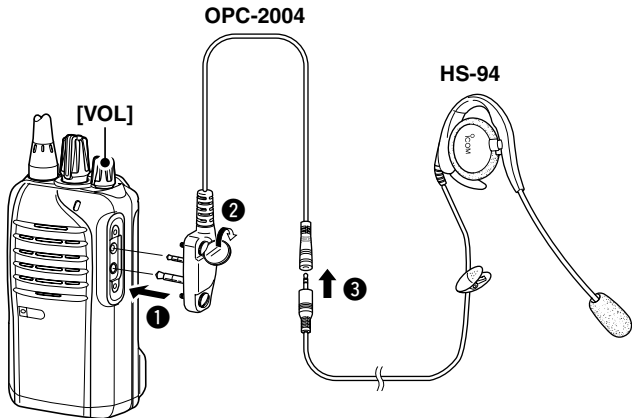

7 OPTIONS

◇ Turning the VOX function ON or OFF

The VOX function can be turned ON or OFF when turning the transceiver power ON.

- ① Rotate [VOL] to turn the transceiver power OFF.
- ② Set [ROTARY SELECTOR] to any channel other than Channel 16.
- ③ While holding down [PTT] and [Upper], rotate [VOL] to turn ON the power to switch the VOX function ON or OFF.
 - One beep sounds when the VOX function is turned OFF.
 - Two beeps sound when the VOX function is turned ON.

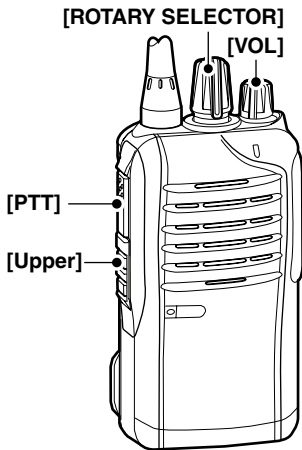

NOTE: This operation may not be available, depending on the presetting. Ask your dealer for details.

◇ Setting the VOX gain

The VOX sensitivity level can be adjusted from 1 (minimum) to 10 (maximum).

- ① Connect the optional headset (HS-94, HS-95 or HS-97) and OPC-2004. (p. 48)
- ② Rotate [VOL] to turn the transceiver power OFF.
- ③ Set [ROTARY SELECTOR] to Channel 16.
- ④ While holding down [PTT] and [Upper], rotate [VOL] to turn ON the power and enter the VOX gain adjustment mode.
- ⑤ Push [Upper] to increase, or push [Lower] to decrease the VOX gain while speaking into the optional headset.
 - The adjustable range is 1 (minimum) to 10 (maximum).
 - A beep sounds after pushing [Upper] or [Lower].
If the level is set on 1 or 10, an error beep sounds after pushing. Therefore, you can determine the current level setting by the type of beep that sounds.
- ⑥ Rotate [VOL] to turn the power OFF, then ON to exit the VOX gain adjustment mode.

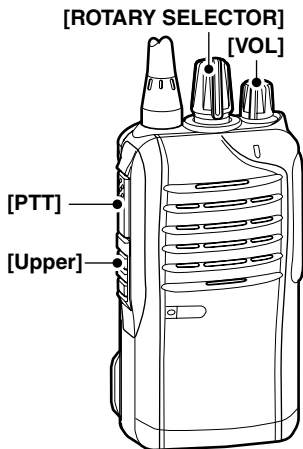

NOTE:

- This operation may not be available, depending on the presetting. Ask your dealer for details.
- Set the microphone gain before setting the VOX gain. (p. 20)

8 INFORMATION

■ Country code list

• ISO 3166-1

	Country	Codes		Country	Codes
1	Austria	AT	18	Liechtenstein	LI
2	Belgium	BE	19	Lithuania	LT
3	Bulgaria	BG	20	Luxembourg	LU
4	Croatia	HR	21	Malta	MT
5	Czech Republic	CZ	22	Netherlands	NL
6	Cyprus	CY	23	Norway	NO
7	Denmark	DK	24	Poland	PL
8	Estonia	EE	25	Portugal	PT
9	Finland	FI	26	Romania	RO
10	France	FR	27	Slovakia	SK
11	Germany	DE	28	Slovenia	SI
12	Greece	GR	29	Spain	ES
13	Hungary	HU	30	Sweden	SE
14	Iceland	IS	31	Switzerland	CH
15	Ireland	IE	32	Turkey	TR
16	Italy	IT	33	United Kingdom	GB
17	Latvia	LV			

■ Disposal



The crossed-out wheeled-bin symbol on your product, literature, or packaging reminds you that in the European Union, all electrical and electronic products, batteries, and **■** accumulators (rechargeable batteries) must be taken to designated collection locations at the end of their working life. Do not dispose of these products as unsorted municipal waste. Dispose of them according to the laws in your area.

Count on us!

< Intended Country of Use >

AT BE CY CZ DK EE
FI FR DE GR HU IE
IT LV LT LU MT NL
PL PT SK SI ES SE
GB IS LI NO CH BG
RO TR HR

A-7061D-1EU-②

Printed in Japan

© 2012–2016 Icom Inc.

Printed on recycled paper with soy ink.

Icom Inc.

1-1-32 Kamiminami, Hirano-ku, Osaka 547-0003, Japan