



INSTRUCTION MANUAL

VHF TRANSCEIVERS

IC-F3032T

IC-F3032S

UHF TRANSCEIVERS

IC-F4032T

IC-F4032S

**MDC 1200
Compatible**

Icom Inc.



The photo shows the
VHF transceiver (S type)

IMPORTANT

READ ALL INSTRUCTIONS carefully and completely before using the transceiver.

SAVE THIS INSTRUCTION MANUAL — This instruction manual contains important operating instructions for the **IC-F3032T/IC-F3032S VHF TRANSCEIVERS** and the **IC-F4032T/IC-F4032S UHF TRANSCEIVERS**.

This instruction manual includes some functions which are usable only when they are pre-programmed by your dealer. Ask your dealer for details.

EXPLICIT DEFINITIONS

WORD	DEFINITION
⚠ DANGER!	Personal death, serious injury or an explosion may occur.
⚠ WARNING!	Personal injury, fire hazard or electric shock may occur.
CAUTION	Equipment damage may occur.
NOTE	If disregarded, inconvenience only. No risk of personal injury, fire or electric shock.

DISPOSAL



The crossed-out wheeled-bin symbol on your product, literature, or packaging reminds you that in the European Union, all electrical and electronic products, batteries, and accumulators (rechargeable batteries) must be taken to designated collection locations at the end of their working life. Do not dispose of these products as unsorted municipal waste. Dispose of them according to the laws in your area.

PRECAUTIONS

⚠ **DANGER! NEVER** short the terminals of the battery pack. Also, current may flow into nearby metal objects such as a key, so be careful when placing the battery packs (or the transceiver) in handbags, etc. Simply carrying with or placing near metal objects such as a key, etc. may cause shorting. This may damage not only the battery pack, but also the transceiver.

⚠ **DANGER!** Use and charge only specified Icom battery packs with Icom transceivers or Icom chargers. Only Icom battery packs are tested and approved for use with Icom transceivers or charged with Icom chargers. Using third-party or counterfeit battery packs or chargers may cause smoke, fire, or cause the battery to burst.

⚠ **WARNING! NEVER** hold the transceiver so that the antenna is very close to, or touching exposed parts of the body, especially the face or eyes, while transmitting. The transceiver will perform best if the microphone is 5 to 10 cm away from the lips and the transceiver is vertical.

⚠ **WARNING! NEVER** operate the transceiver with a headset or other audio accessories at high volume levels. The continuous high volume operation may cause a ringing in your ears. If you experience the ringing, reduce the volume level or discontinue use.

⚠ **WARNING! NEVER** operate the transceiver while driving a vehicle. Safe driving requires your full attention—anything less may result in an accident.

CAUTION: MAKE SURE the flexible antenna, battery pack and jack cover are securely attached to the transceiver, and that the antenna and battery pack are dry before attachment. Exposing the inside of the transceiver to dust or water will result in serious damage to the transceiver.

DO NOT operate the transceiver near unshielded electrical blasting caps or in an explosive atmosphere.

DO NOT push [PTT] when not actually intending to transmit.

DO NOT operate or place the transceiver in direct sunlight or in areas with temperatures below -25°C or above $+55^{\circ}\text{C}$.

DO NOT modify the transceiver. The specifications may change and then not comply with the requirements of a corresponded regulation. The transceiver warranty does not cover any problems caused by unauthorized modification.

DO NOT use harsh solvents such as benzine or alcohol when cleaning, as they will damage the transceiver surfaces.

BE CAREFUL! The transceiver will become hot when operating it continuously for long periods of time.

PRECAUTIONS (Continued)

BE CAREFUL! The transceiver meets IP67* requirements for dust-tight and waterproof protection. However, once the transceiver has been dropped, dust-tight and waterproof protection cannot be guaranteed because of possible damage to the transceiver's case or the waterproof seal.

* Only when the jack cover or the optional HM-168LWP is attached.

Even when the transceiver power is OFF, a slight current still flows in the circuits. Remove the battery pack or batteries from the transceiver when not using it for a long time. Otherwise, the installed battery pack or batteries will become exhausted, and will need to be recharged or replaced.

MAKE SURE to turn OFF the transceiver power before connecting the supplied/optional equipment.

TABLE OF CONTENTS

IMPORTANT	i	4 BATTERY CHARGING	15–19
EXPLICIT DEFINITIONS	i	■ Caution	15
PRECAUTIONS	ii	■ Optional battery chargers	17
FCC INFORMATION	iii	5 OPTIONAL SWIVEL BELT CLIP	20–21
TABLE OF CONTENTS	iv	■ MB-93 contents	20
1 ACCESSORIES	1–2	■ Attaching	20
■ Supplied accessories	1	■ Detaching	21
■ Accessory attachments	1	6 SPEAKER MICROPHONE	22
2 PANEL DESCRIPTION	3–7	■ Optional HM-168LWP description	22
■ Front panel	3	■ Attachment	22
■ Function display	4	7 OPTIONS	23–24
■ Programmable function keys	5	8 COUNTRY CODE LIST	25
3 BASIC OPERATION	8–14		
■ Turning power ON	8		
■ Channel selection	9		
■ Call procedure	9		
■ Receiving and transmitting	10		
■ User set mode	12		
■ Emergency Call	12		
■ Priority A channel selection	13		
■ Man Down Emergency Call	13		
■ Stun function	13		
■ Scrambler function	13		
■ MDC 1200 system operation	14		

■ Supplied accessories

/// **NOTE:** Some accessories are not supplied with depending on versions.

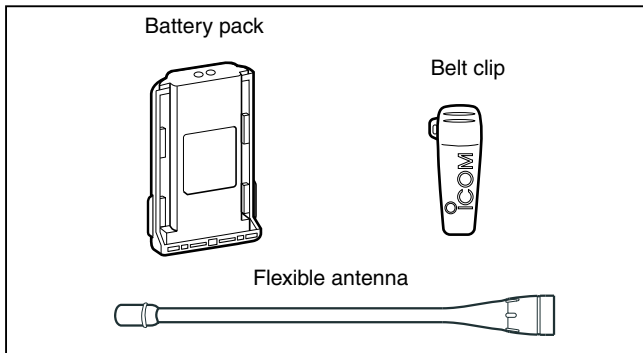

■ Accessory attachments

◇ Flexible antenna

Connect the supplied flexible antenna to the antenna connector.

/// **CAUTION:**

- **NEVER** carry the transceiver by holding the antenna.
- **DO NOT** connect the antenna other than listed on page 24.
- Transmitting without an antenna may damage the transceiver.

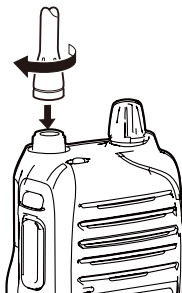

◇ Battery pack

To attach the battery pack:

Slide the battery pack in the direction of the arrow (1) until the battery release button makes a 'click' sound.

/// **NOTE:** Push on the bottom of the pack to make sure the release button is firmly locked.

To release the battery pack:

Slide the battery release button in the direction of the arrow (2) as shown below. The battery pack is then released.

/// **NEVER** release or attach the battery pack when the transceiver is wet or soiled. This may result water or dust getting into the transceiver/battery pack and may result in the transceiver being damaged.

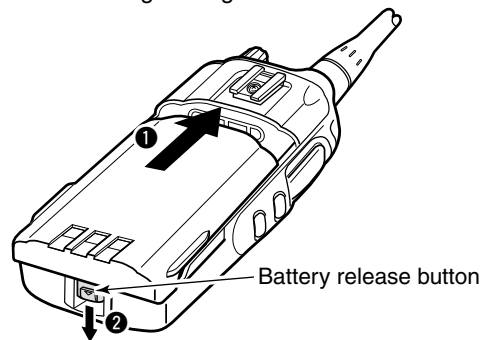

/// **NOTE:** Keep the battery terminals clean. It's a good idea to occasionally clean them.

◇ Belt clip

To attach the belt clip:

- ① Release the battery pack if it is attached.
- ② Slide the belt clip in the direction of the arrow until the belt clip is locked and makes a 'click' sound.

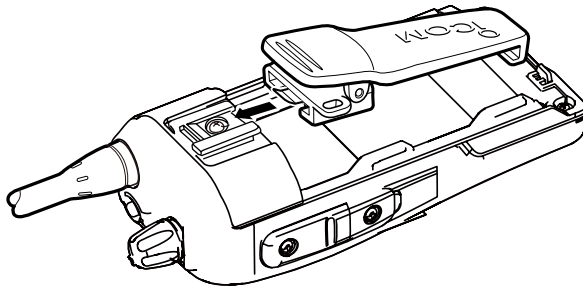

To detach the belt clip:

- ① Release the battery pack if it is attached.
- ② Pinch the clip (1), and slide the belt clip in the direction of the arrow (2).

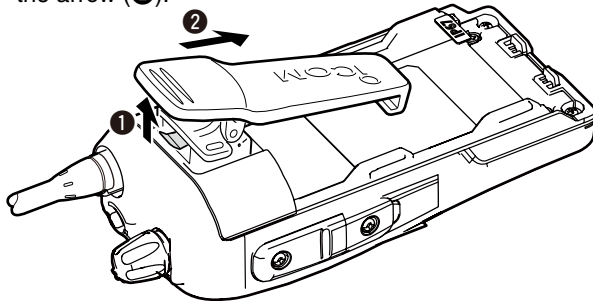

◇ Jack cover

To attach the jack cover:

- ① Attach the jack cover to the [MIC/SP] jack.
- ② Tighten the screws.

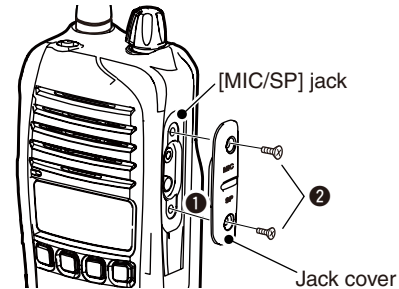

CAUTION:

- Attach the jack cover when the optional speaker-microphone is not used.
- Use the supplied screws only.

To detach the jack cover:

- ① Unscrew the screws using a phillips screwdriver.
- ② Detach the jack cover for the speaker-microphone or headset connection.

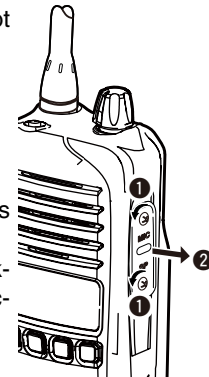

■ Front panel

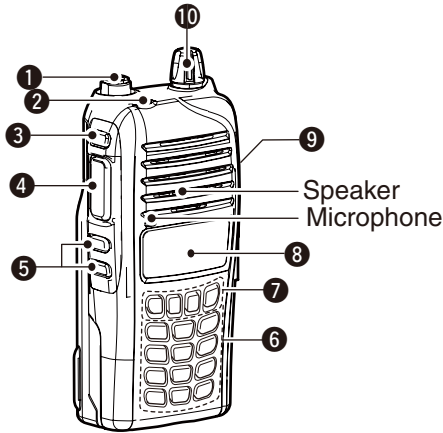

1 ANTENNA CONNECTOR

Connects the supplied antenna.

2 DEALER-PROGRAMMABLE KEY [Emer]

Desired function can be programmed by your dealer. (p. 7)

3 DEALER-PROGRAMMABLE KEY [Side1]

Desired function can be programmed by your dealer. (p. 5)

4 PTT SWITCH [PTT]

Push and hold to transmit; release to receive.

5 DEALER-PROGRAMMABLE KEYS [Side2]/[Side3]

Desired functions can be programmed independently by your dealer. (p. 5)

6 10-KEYPAD (Depending on version)

The keypad allows you to enter digits to:

- Select memory channels and tone channels
- Select DTMF codes (during transmit)
- Set TX codes
- Start up with the password

7 DEALER-PROGRAMMABLE KEYS [P0] to [P3]

Desired functions can be programmed independently by your dealer. (p. 5)

8 FUNCTION DISPLAY (p. 4)

Displays a variety of information such as an operating channel number/name, 2-tone code, DTMF numbers, selected function and so on.

9 EXTERNAL MICROPHONE/SPEAKER JACK

Connect an optional speaker-microphone.

NOTE: Connect or disconnect the optional equipment after the transceiver is turned OFF.

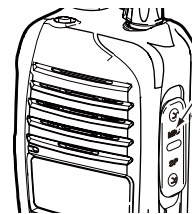

Jack cover

NOTE: Attach the jack cover when the optional equipment is not used. See (p. 2) for details.

10 VOLUME CONTROL [VOL]

Rotate to turn the power ON/OFF and adjusts the audio level.

■ Function display

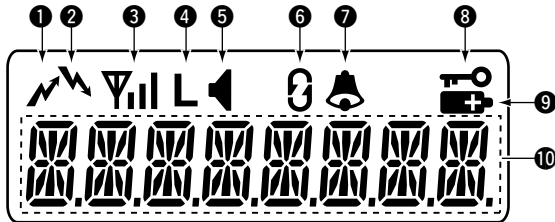

❶ TRANSMIT INDICATOR

Appears while transmitting.

❷ BUSY INDICATOR

Appears while the channel is busy.

❸ SIGNAL STRENGTH INDICATOR

Indicates relative signal strength level.

❹ LOW POWER INDICATOR

Appears when low output power is selected.

- When the battery power decreases to a specified level, low power is selected automatically.

❺ AUDIBLE INDICATOR

- ➔ Appears when the channel is in the 'audible' (unmute) condition.
- ➔ Appears when the specified 2-tone code is received.

❻ SCRAMBLER INDICATOR

Appears when the voice scrambler function is activated.

❼ BELL INDICATOR

Appears or blinks when the specific 2-tone code is received, according to the pre-programming.

❽ KEY LOCK INDICATOR

Appears during the key lock function is ON.

❾ BATTERY INDICATOR

Appears or blinks when the battery power decreases to a specified level.

❿ ALPHANUMERIC DISPLAY

Displays an operating channel number, channel name, Set mode contents, DTMF code, etc.

2 PANEL DESCRIPTION

■ Programmable function keys

The following functions can be assigned to **[Emer]**, **[Side1]**, **[Side2]**, **[Side3]**, **[P0]**, **[P1]**, **[P2]** and **[P3]** programmable function keys.

Consult your Icom dealer or system operator for details concerning your transceivers programming.

If the programmable function names are bracketed in the following explanations, the specific key is used to activate the function depends on the programming.

CH UP AND DOWN KEYS

- ➔ Push to select an operating channel.
- ➔ Push to select a transmit code channel after pushing [TX Code CH Select].
- ➔ Push to select a DTMF channel after pushing [DTMF Audial].
- ➔ Push to select a scan group after pushing and holding [Scan A Start/Stop]/[Scan B Start/Stop] for 1 second.

SIREN KEY

Push to emit a siren.

ZONE KEY

Push this key, then push [CH Up] or [CH Down] to select the desired zone.

 **What is “zone”?**— The desired channels are assigned into a zone according to the intended use for grouping. For example, ‘Staff A’ and ‘Staff B’ are assigned into a “Business” zone, and ‘John’ and ‘Cindy’ are assigned into a “Private” zone.

SCAN A KEY

- ➔ This key’s operation depends on the Power ON Scan setting.

When the power ON scan function is turned OFF;

Push to start and cancel scanning operation. In case of transmission during scan, scanning will be cancelled.

When the power ON scan function is turned ON;

Push to pause scanning, then resumes scanning after passing a specified time period. In case of transmission during scan, scanning will be cancelled.

- ➔ Push and hold this key for 1 second to indicate the scan group, then push [CH Up] or [CH Down] to select the desired group.

SCAN B KEY

- ➔ Push to start and cancel scanning operation. In case of transmission during scan, scanning will be paused. Then resumes scanning after passing a specified time period.
- ➔ Push and hold this key for 1 second to indicate the scan group, then push [CH Up] or [CH Down] to select the desired group.

PRIO A/B KEYS

- ➔ Push to select Priority A or Priority B channel.
- ➔ Push and hold [Prio A (Rewrite)] or [Prio B (Rewrite)] for 1 second to reassign the operating channel to Priority A or Priority B channel.

SCAN ADD/DEL (TAG) KEY

- Push to add a channel to, or delete it from the current scan list.
 - When a channel is added to the current scan list, the display shows “SCAN ON.” When a channel is deleted from the current scan list, the display shows “SCAN OFF.” After showing “SCAN ON” or “SCAN OFF,” the display shows the current scan list text.
- You can add a channel to, or delete it from the scan list after selecting the list.
 1. Hold down for 1 second to display the current scan list, and then push [CH Up] or [CH Down] to select a desired list.
 2. Push this key to add a channel to, or delete it from the selected list.
 3. Hold down this key for 1 second to exit the scan list selection mode.
- Push this key while a scan is paused on a channel, except for primary or secondary channel, and then the channel is deleted from the scan list.
 - Depending on the setting, the deleted channel is added to the scan list again after the scan is cancelled. (Nuisance Delete function)

C.TONE CH ENT KEY

Push to select the continuous tone channel using [CH Up]/[CH Down] to change the tone frequency/code setting. The selected channel remains set as the continuous tone channel until another channel is designated as such.

MR-CH 1/2/3/4 KEYS

Push to select memory channels 1 to 4 in the operating zone directly.

MONI KEY

Mute and release the CTCSS (DTCS) or 2-tone squelch mute. Open any squelch/deactivate any mute while pushing and holding this key.

LOCK KEY

- Push and hold for 1 second to electronically lock all programmable keys except the following: [Call] (incl. Call A and Call B), [Moni], [Emergency], [Surveillance], [Siren], [Lone Worker] and [OPT 1/2/3].
- Push and hold for 1 second again to turn the lock function OFF.

HIGH/LOW KEY

Push to select the transmit output power temporarily or permanently, depending on the presetting.

- Ask your dealer for the output power level for each selection.

OPT MOMENTARY KEYS

Controls the output signal level of the optional ports in the optional unit connector while pushing and holding this key.

OPT OUT KEYS

Push to control the output signal level of the optional ports in the optional unit connector.

SCRAMBLER FUNCTION

Push to toggle the voice scrambler function ON and OFF.

2 PANEL DESCRIPTION

TALK AROUND KEY

Push to turn the talk around function ON and OFF.

- The talk around function equalizes the transmit frequency to the receive frequency for transceiver-to-transceiver communication.

WIDE/NARROW KEY

Push to toggle the IF bandwidth between wide and narrow.

DTMF AUTODIAL KEY

- ➔ Push to enter the DTMF channel selection mode. Then select the desired DTMF channel using [CH Up]/[CH Down].
- ➔ After selecting the desired DTMF channel, push this key to transmit the DTMF code.

RE-DIAL KEY

Push to transmit the last-transmitted DTMF code.

CALL KEYS

Push to transmit a 2-tone.

- Call transmission is necessary before you call another station depending on your signaling system.
- [Call A] and/or [Call B] may be available when your system employs selective 'Individual/Group' calls. Ask your dealer which call is assigned to each key.

LONE WORKER KEY

Push to turn the Lone Worker function ON or OFF.

- If the Lone Worker function is activated, the Emergency function is automatically turned ON after the specified time period has passed with no operation is performed.

TX CODE CHANNEL UP/DOWN KEYS

Push to select a TX code channel directly.

EMERGENCY KEY

Push and hold to transmit the emergency call.

- The transceiver can transmit the emergency call silently or audibly depending on the presetting. Ask your dealer for details.
- When the emergency call transmits with beeps, the emergency text is displayed on the LCD if programmed.
- If you want to cancel the emergency call, push and hold the key again before transmitting the call.
- The emergency call is transmitted one time only or repeatedly until receiving a control code, depending on the presetting.

SURVEILLANCE KEY

Push to turn the surveillance function ON or OFF.

When this function is turned ON, the beep is not emitted and the LCD backlight does not light when a signal is received or a key is pushed, etc.

TX CODE CHANNEL SELECT KEY

Push to enter the ID code channel selection mode directly. Then set the desired channel using [CH Up]/[CH Down] or 10-keypad*. (p. 11)

*10-key versions only

USER SET MODE KEY

- ➔ Push and hold for 1 second to enter user set mode.
 - During in the user set mode, push this key to select an item that is enabled by your dealer, and change the value or condition by pushing [CH Up] or [CH Down].
- ➔ Push and hold this key for 1 second again to exit user set mode.

■ Turning power ON

/// Prior to using the transceiver for the first time, the battery pack must be fully charged for optimum life and operation. (p. 17)

- ① Rotate [VOL] to turn the power ON.
- ② If the transceiver is programmed for a start up password, input the digit codes as directed by your dealer.
 - 10-keypad can be used for password input depending on version:
 - The keys in the table below can be used for password input:
 - The transceiver detects numbers in the same block as identical. Therefore "01234" and "56789" are the same.

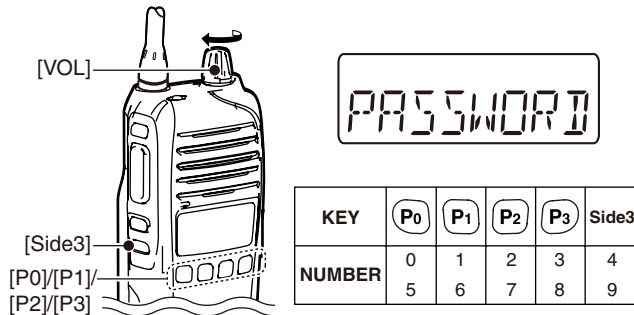

- ③ When the "PASSWORD" indication does not clear after inputting 4 digits, the input code number may be incorrect. Turn the power off and start over in this case.

◇ Battery type selection

The battery type must be selected according to the attaching battery type when turning the transceiver ON. Ask your dealer for details.

- ① Turn the power OFF.
- ② While pushing and holding [Emer] and [PTT], turn the power ON with rotating [VOL] to toggle the attaching battery type.
 - After the display appears, release [Emer] and [PTT].
 - "DRY BATT" is displayed for about 3 seconds then "L" appears when the battery case operation is selected. In this case, the transmit output power is low.
 - "LI-ION" is displayed for about 3 seconds when the Lithium-ion battery operation is selected.

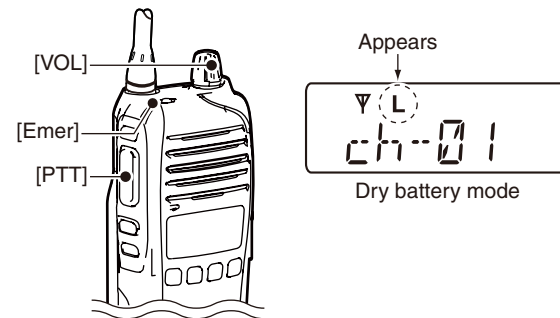

3 BASIC OPERATION

■ Channel selection

Several types of channel selections are available. Methods may differ according to your system set up.

NON-ZONE TYPE:

Push [CH Up] or [CH Down] to select the desired operating channel, in sequence; or, push one of [MR-CH 1] to [MR-CH 4] keys to select a channel directly.

ZONE TYPE:

Push [Zone], then push [CH Up] or [CH Down] to select the desired zone.

AUTOMATIC SCAN TYPE:

Channel setting is not necessary for this type. When turning power ON, the transceiver automatically starts scanning. Scanning stops when receiving a call.

■ Call procedure

When your system employs tone signaling (excluding CTCSS and DTCS), the call procedure may be necessary prior to voice transmission. The tone signaling employed may be a selective calling system which allows you to call specific station(s) and prevent unwanted stations from contacting you.

- ① Select the desired TX code channel or 2-tone code according to your System Operator's instructions.
 - This may not be necessary depending on programming.
 - Refer to page 13 for selection.
- ② Push the call key (assigned to one of the dealer programmable keys: [Emer], [Side1], [Side2], [Side3], [P0], [P1], [P2] and [P3]) or [PTT].
- ③ After transmitting a 2-tone code, the remainder of your communication can be carried out in the normal fashion.

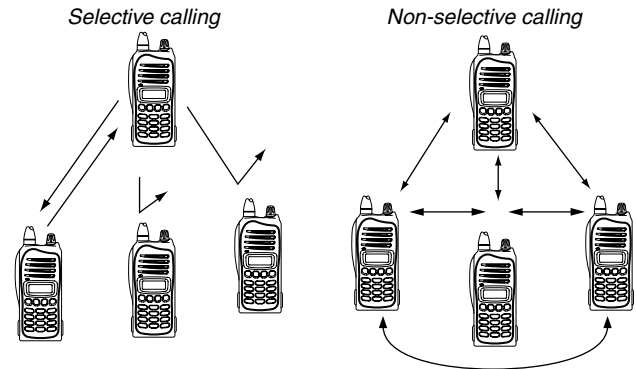

■ Receiving and transmitting

CAUTION: Transmitting without an antenna may damage the transceiver. See page 1 for accessory attachments.

Receiving:

- ① Rotate [VOL] to turn the power ON.
- ② Push [CH Up] or [CH Down] to select the conventional system channel, in sequence.
- ③ When receiving a call, adjust the audio output level to a comfortable listening level.

NOTE: When a matched RX code signal is received, audio from the microphone is automatically transmitted for a specified time period.*

* Depending on the presetting. Ask your dealer for details.

Transmitting:

Wait for the channel to become clear to avoid interference.

- ① Push [Call] when initiating a call from your side.
 - Coded audio may be heard from the transceiver, then “

IMPORTANT: To maximize the readability of your signal;

1. Pause briefly after pushing [PTT].
2. Hold the microphone 5 to 10 cm from your mouth, then speak into the microphone at a normal voice level.

◇ Transmitting notes

• Transmit inhibit function

The transceiver has several inhibit functions which restrict transmission under the following conditions:

- The channel is in mute condition (‘Inaudible’ condition; “

• Time-out timer

After continuous transmission for the pre-programmed time period, the time-out timer is activated, causing the transceiver to stop transmitting.

• Penalty timer

Once the time-out timer is activated, transmission is further inhibited for a period determined by the penalty timer.

• PTTID call

The transceiver sends the ID code (DTMF or digital ANI) automatically when [PTT] is pushed (beginning of transmission) and released (end of transmission) depends on the setting.

3 BASIC OPERATION

◇ TX code channel selection

If the transceiver has [TX Code CH Select] assigned to it, the indication can be toggled between the operating channel number (or name) and TX code channel number (or name). When the TX code channel number (or name) is displayed, [CH Up] or [CH Down] selects the TX code channel.

USING [TX CODE CH SELECT] KEY:

- ① Push [TX Code CH Select] to enter the TX code channel selection mode.
 - Select the desired channel with [CH Up] or [CH Down] if necessary.
- ② Push and hold [TX Code CH Select] for 1 sec. to enter the TX code edit mode.
- ③ Push [TX Code CH Select] several times to select the desired digit to be edited.
 - The digit to be edited blinks.
- ④ Push [CH Up], [CH Down] or 10-keypad to set the desired digit.
- ⑤ Push [TX Code CH Select] to set the digit. The digit to the right will blink automatically.
 - When the 10-keypad is used for setting, the digit to be edited moves to the right automatically without pushing [TX Code CH Select].
- ⑥ Repeat ④ and ⑤ to input all allowable digits.
- ⑦ After setting the last digit, push [TX Code CH Select] to set the code and return to the stand-by mode.

USING [TX CODE CH UP]/[TX CODE CH DOWN] KEY:

If the transceiver has [TX Code CH Up] or [TX Code CH Down] assignment, the programmed TX code channel can be selected directly when pushed.

◇ DTMF transmission

If the transceiver has [DTMF Autodial] assigned to it, the automatic DTMF transmission function is available. Up to 8 DTMF channels are available.

TO SELECT A TX CODE:

- ① Push [DTMF Autodial]— a DTMF channel appears.
- ② Push [CH Up] or [CH Down] to select the desired DTMF channel.
- ③ Push [DTMF Autodial] to transmit the DTMF code in the selected DTMF channel.

■ User set mode

You can “customize” the transceiver operation to suit your preferences and operating style.

Entering the user set mode:

- ① Hold down [User Set Mode] for 1 second to enter the user set mode.
- ② Push [User Set Mode] one or more times to select the appropriate item. Then push [CH Up] or [CH Down] to set the desired level or condition.
 - Available set mode functions are **Backlight, Beep, Beep Level, SQL Level, Mic Gain, Battery Voltage, Signal Moni and Lone Worker.**
- ③ Hold down [User Set Mode] for 1 second again to exit the set mode.

/// **NOTE:** User set mode is also available via a programmable function key. Refer to “USER SET MODE KEY.” (p. 7)

■ Emergency Call

When [Emergency] is pushed for the specified time period*, the emergency signal is transmitted once, or repeatedly, on the specified emergency channel.

A repeat emergency signal is automatically transmitted until the transceiver receives an acknowledgement signal, or you turn the transceiver power OFF.

When no emergency channel is specified, the signal is transmitted on the previously selected channel.

If you want to cancel the emergency call, hold down [Emergency] again before transmitting the call.

If your transceiver is programmed for Silent operation, you can transmit an Emergency call without the beep sounding and the LED indicator lighting.

/// **IMPORTANT:** It is recommended to set an emergency channel individually to provide the certain emergency call operation.

* Depending on the presetting. Ask your dealer for details.

◇ NOTES

Depending on the presetting, the following functions are automatically activated. Ask your dealer for details.

• Auto TX function

After the emergency call transmission, audio from the microphone is automatically transmitted for a specified time period.*

• Auto RX function

After the emergency call transmission, the transceiver stands by in the audible mode for the specified time period.*

3 BASIC OPERATION

■ Priority A channel selection

Depending on the presetting, the Priority A channel is selected each time the transceiver power is turned ON.

■ Man Down Emergency Call

This function requires the optional UT-124R MAN DOWN UNIT. When the transceiver has been left in a horizontal position for the specified time period*, the transceiver enters the emergency mode, and then the countdown starts.

After the specified time period* has passed, an emergency call is automatically transmitted once, or repeatedly.

If the transceiver is placed in a vertical position before the first transmission, the transceiver exits the emergency mode and the emergency call is cancelled.

 **IMPORTANT:** It is recommended to set an emergency channel individually to provide the certain emergency call operation.

* Depending on the presetting. Ask your dealer for details.

■ Stun function

When the specified ID, set as a stun ID or kill ID, is received, the stun function is activated.

When the stun ID is received, the transceiver becomes unusable. Entering of the password (p. 8) or receiving a specified ID, set as a revive ID, is necessary to operate the transceiver again in this case.

When the kill ID is received, the transceiver switches to the cloning required condition. Cloning the transceiver is necessary to operate the transceiver again in this case.

Stun function is also available with the MDC 1200 signaling system. (p. 14)

■ Scrambler function

The voice scrambler function provides private communication between stations. The optional Rolling or Non-rolling type can be available.

- ① Push [Scrambler] to turn the scrambler function ON.
 - “G” appears.
- ② Push [Scrambler] again to turn the scrambler function OFF.
 - “G” disappears.

■ MDC 1200 system operation

The MDC 1200 signaling system enhances your transceiver's capabilities. It allows PTT ID*, Emergency signaling, and receiving Radio Check. Also, the dispatcher can stun and revive transceivers on the system.

* When [PTT] is pushed and/or released, the transceiver transmits your station ID.

◇ Transmitting an Emergency Call

The MDC 1200 system's Emergency feature can be accessed using the [Emergency] key (p. 7). The transceiver will send an Emergency MDC 1200 system command once, or repeatedly for a programmed number of times until it receives the acknowledgement signal.

The emergency call can be transmitted without a beep sound depending on how the emergency function is programmed. Ask your dealer for details.

◇ Receiving an Emergency Call

- ① When an emergency call is received;
 - Beeps sound.
 - The calling station alias and "EMG EMG" are displayed alternately.

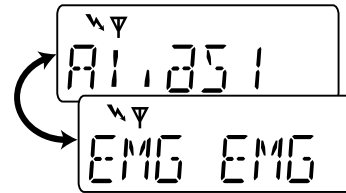

- ② Turn power OFF, change the channel, push [PTT] for replying the call, etc. to stop the beep and display indication.

◇ Receiving a Stun and Revive

The dispatcher can send MDC 1200 system signals that will stun or revive your transceiver. If a Stun command is received that matches your station ID, the transceiver will display "SORRY" (default) and you can not receive or transmit. When a Revive command is received that matches your station ID, normal operation is restored.

■ Caution

- Misuse of Lithium-ion batteries may result in the following hazards: smoke, fire, or the battery may rupture. Misuse can also cause damage to the battery or degradation of battery performance.
- Prior to using the battery pack for the first time, or after not using it for a long time, you must fully charge the pack. Otherwise, the transceiver may not turn ON.

Battery caution

⚠ **DANGER! DO NOT** hammer or otherwise impact the battery. Do not use the battery if it has been severely impacted or dropped, or if the battery has been subjected to heavy pressure. Battery damage may not be visible on the outside of the case. Even if the surface of the battery does not show cracks or any other damage, the cells inside the battery may rupture or catch fire.

⚠ **DANGER! NEVER** use or leave battery packs in areas with temperatures above +60°C. High temperature buildup in the battery, such as could occur near fires or stoves, inside a sun heated car, or in direct sunlight may cause the battery to rupture or catch fire. Excessive temperatures may also degrade battery performance or shorten battery life.

⚠ **DANGER! DO NOT** expose the battery to rain, snow, seawater, or any other liquids. Never charge or use a wet battery. If the battery gets wet, be sure to wipe it dry before using.

⚠ **DANGER! NEVER** incinerate used battery packs since internal battery gas may cause them to rupture, or may cause an explosion.

⚠ **DANGER! NEVER** solder the battery terminals or NEVER modify the battery pack. This may cause heat generation, and the battery may rupture, emit smoke or catch fire.

⚠ **DANGER!** Use the battery only with the transceiver for which it is specified. Never use a battery with any other equipment, or for any purpose that is not specified in this instruction manual.

⚠ **DANGER!** If fluid from inside the battery gets in your eyes, blindness can result. Rinse your eyes with clean water, without rubbing them, and see a doctor immediately.

⚠ **WARNING!** Immediately stop using the battery if it emits an abnormal odor, heats up, or is discolored or deformed. If any of these conditions occur, contact your Icom dealer or distributor.

⚠ **WARNING!** Immediately wash, using clean water, any part of the body that comes into contact with fluid from inside the battery.

⚠ **WARNING! NEVER** put the battery in a microwave oven, high-pressure container, or in an induction heating cooker. This could cause a fire, overheating, or cause the battery to rupture.

CAUTION: Always use the battery within the specified temperature range, -20°C to $+55^{\circ}\text{C}$. Using the battery out of its specified temperature range will reduce the battery's performance and battery life.

CAUTION: Shorter battery life could occur if the battery is left fully charged, completely discharged, or in an excessive temperature environment (above $+50^{\circ}\text{C}$) for an extended period of time. If the battery must be left unused for a long time, it must be detached from the transceiver after discharging. You may use the battery until the remaining capacity is about half, then keep it safely in a cool dry place with the temperature range as below:

- 20°C to $+50^{\circ}\text{C}$ (within a month)
- 20°C to $+35^{\circ}\text{C}$ (within three months)

BE SURE to replace the battery pack with a new one approximately five years after manufacturing, even if it still holds a charge. The inside battery material will become weak after a period of time, even with little use. The estimated number of times you can charge the battery is between 300 and 500. Even when the battery appears to be fully charged, the operating time of the transceiver may become short when:

- Approximately five years have passed since the battery was manufactured.
- The battery has been repeatedly charged.

◇ Charging caution

⚠ **DANGER! NEVER** charge the battery pack in areas with extremely high temperatures, such as near fires or stoves, inside a sun heated car, or in direct sunlight. In such environments, the safety/protection circuit in the battery will activate, causing the battery to stop charging.

⚠ **WARNING! NEVER** charge or leave the battery in the battery charger beyond the specified time for charging. If the battery is not completely charged by the specified time, stop charging and remove the battery from the battery charger. Continuing to charge the battery beyond the specified time limit may cause a fire, overheating, or the battery may rupture.

⚠ **WARNING! NEVER** insert the transceiver (battery attached to the transceiver) into the charger if it is wet or soiled. This could corrode the battery charger terminals or damage the charger. The charger is not waterproof.

CAUTION: NEVER charge the battery outside of the specified temperature range: BC-160 and BC-171 (0°C to $+45^{\circ}\text{C}$). BC-119N and BC121N ($+10^{\circ}\text{C}$ to $+40^{\circ}\text{C}$). Icom recommends charging the battery at $+20^{\circ}\text{C}$. The battery may heat up or rupture if charged out of the specified temperature range. Additionally, battery performance or battery life may be reduced.

4 BATTERY CHARGING

■ Optional battery chargers

◇ Rapid charging with the BC-160

The optional BC-160 provides rapid charging of the Li-ion battery pack.

- A power adapter (may be supplied with BC-160 depending on version) or the DC power cable (OPC-515L/CP-23L) is additionally required.

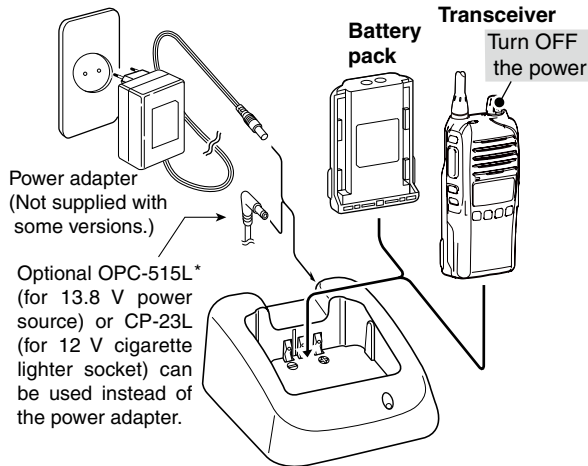

/// ***CAUTION: NEVER** connect the OPC-515L to a power source using reverse polarity. This will ruin the battery charger.
/// White line: ⊕ Black line: ⊖

◇ Regular charging with the BC-171

The optional BC-171 provides regular charging of the Li-ion battery pack.

- A power adapter (may be supplied with BC-171 depending on version) or the DC power cable (OPC-515L/CP-23L) is additionally required.

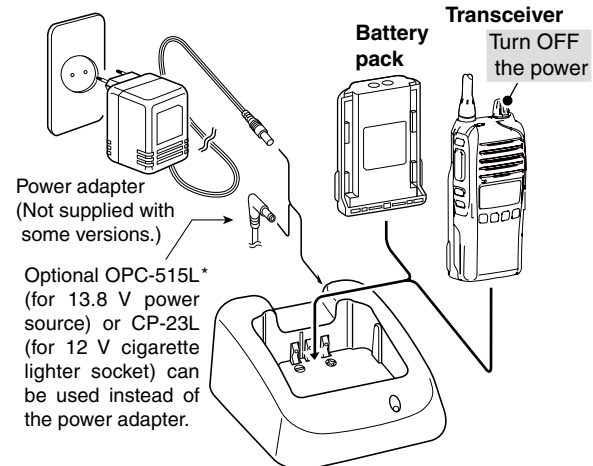

/// ***CAUTION: NEVER** connect the OPC-515L to a power source using reverse polarity. This will ruin the battery charger.
/// White line: ⊕ Black line: ⊖

◆ **AD-106 installation**

The AD-106 CHARGER ADAPTER must be installed into the BC-119N or BC-121N before battery charging.

- Connect the AD-106 CHARGER ADAPTER and the BC-119N/BC-121N as below, then install the AD-106 into the holder space of the BC-119N or BC-121N with the supplied screws.

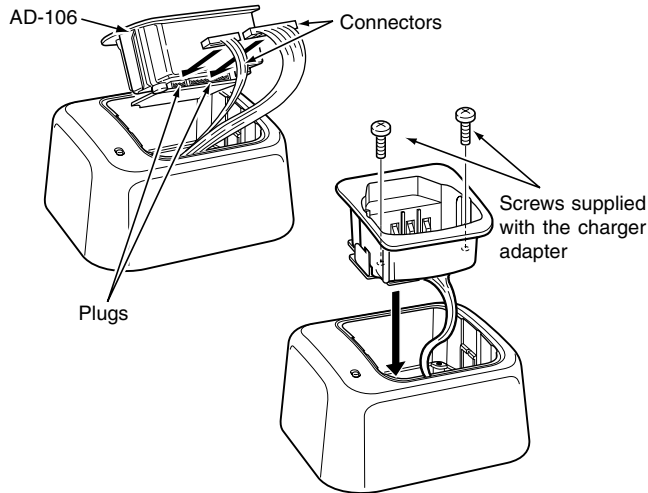

* This illustration is described with the BC-119N.

◆ **Rapid charging with the BC-119N+AD-106**

The optional BC-119N provides rapid charging of the Li-ion battery pack. The following items are additionally required.

- AD-106 charger adapter
- A power adapter (may be supplied with BC-119N depending on version) or the DC power cable (OPC-515L/CP-23L).

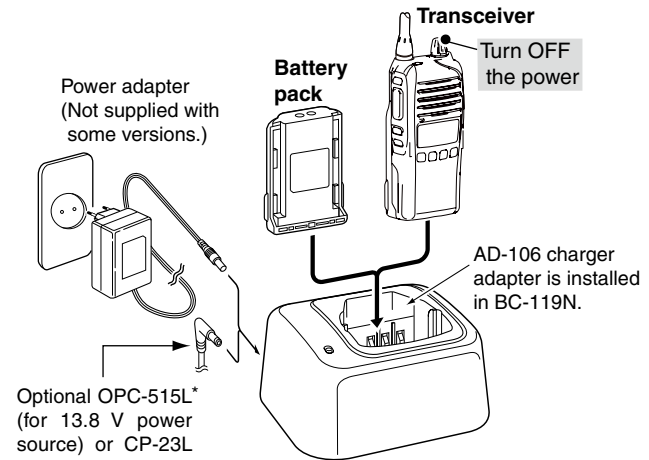

Optional OPC-515L* (for 13.8 V power source) or CP-23L (for 12 V cigarette lighter socket) can be used instead of the power adapter.

/// ***CAUTION: NEVER** connect the OPC-515L to a power source using reverse polarity. This will ruin the battery charger.
 /// White line: ⊕ Black line: ⊖

4 BATTERY CHARGING

◇ Rapid charging with the BC-121N+AD-106

The optional BC-121N allows up to 6 Li-ion battery packs to be charged simultaneously. The following items are additionally required.

- Six AD-106 charger adapters
- An optional power adapter or the DC power cable (OPC-656)

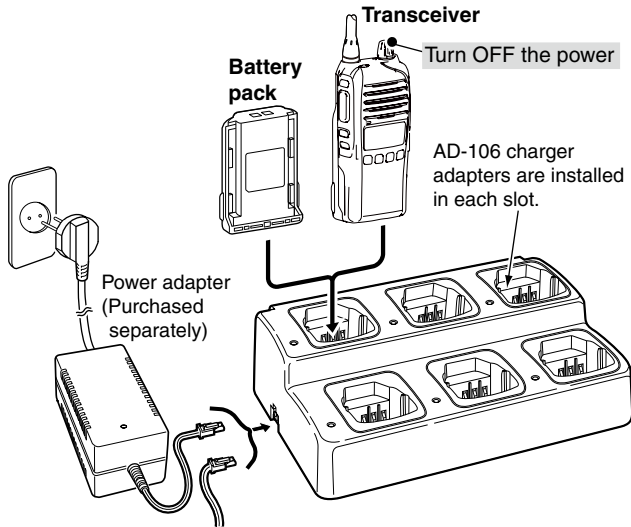

DC power cable (OPC-656)
(Connect with the DC power supply; 13.8 V/at least 7 A)

- /// **CAUTION: NEVER** connect the OPC-656 to a power source using reverse polarity. This will ruin the battery charger.
- /// Red line: ⊕ Black line: ⊖

/// IMPORTANT: Battery charging caution

- /// Ensure the guide tabs on the battery pack are correctly aligned with the guide rails inside the charger adapter.
- /// (This illustration is described with the BC-160.)

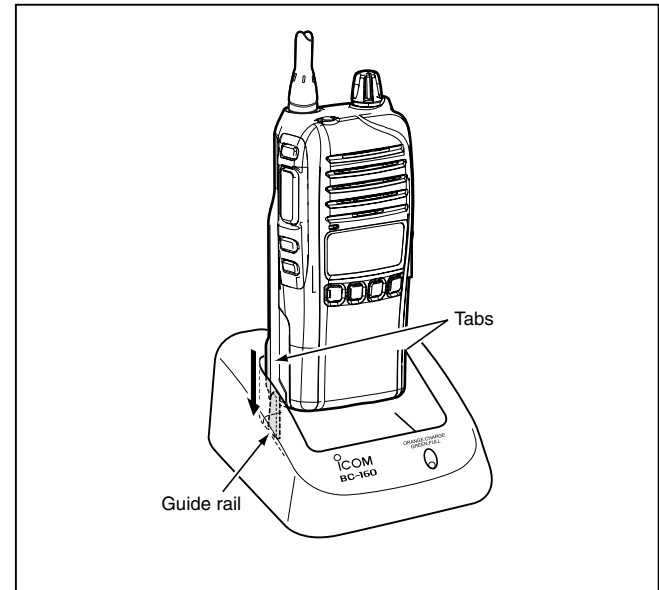

OPTIONAL SWIVEL BELT CLIP

5

■ MB-93 contents

- | | Qty. |
|-------------------|------|
| ① Belt clip | 1 |
| ② Base clip | 1 |

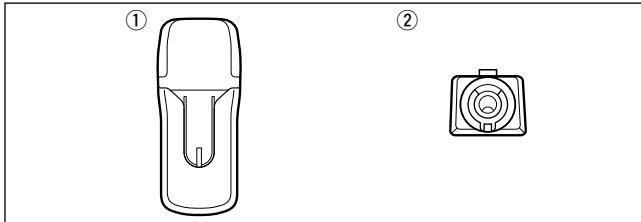

■ Attaching

- ① Release the battery pack if it is attached. (p. 2)
- ② Slide the base clip in the direction of the arrow until the base clip is locked and makes a 'click' sound.

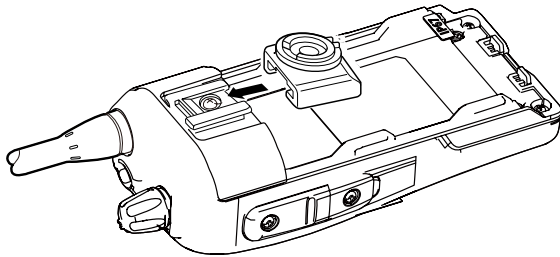

- ③ Attach the battery pack. (p. 2)

- ④ Clip the belt clip to a part of your belt. And insert the transceiver into the belt clip until the base clip inserted fully into the groove.

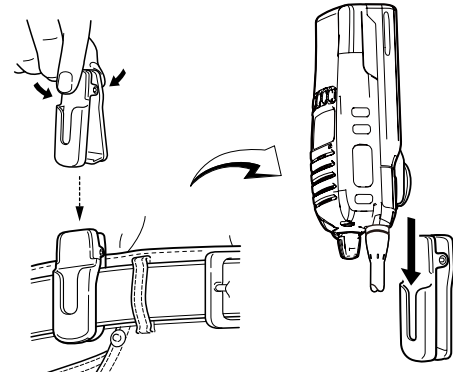

- ⑤ Once the transceiver is locked in place, it swivels as illustrated below.

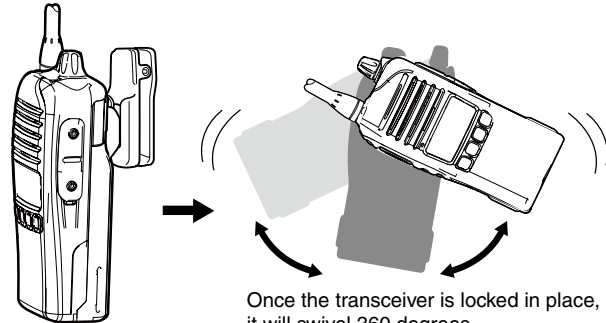

Once the transceiver is locked in place, it will swivel 360 degrees.

4

5

5 OPTIONAL SWIVEL BELT CLIP

■ Detaching

- ① Turn the transceiver upside down in the direction of the arrow and pull out from the belt clip.

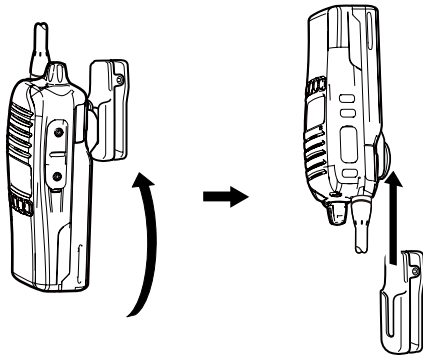

- ② Release the battery pack if it is attached. (p. 2)
- ③ Pinch the clip (①), and slide the base clip in the direction of the arrow (②).

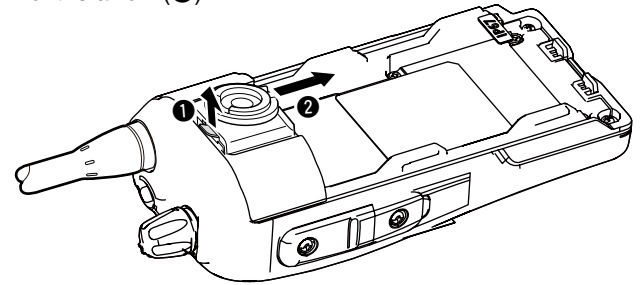

CAUTION:
HOLD THE TRANSCEIVER TIGHTLY, WHEN HANGING OR DETACHING THE TRANSCEIVER FROM THE BELT CLIP.
Otherwise the transceiver may not be attached to the holder or swivel properly if the transceiver is accidentally dropped and the base clip is scratched or damaged.

Optional HM-168LWP description

Alligator type clip

To attach the speaker-mic. to your shirt or collar, etc.

PTT switch

Transmits while pushed
Receives while released

Microphone

Speaker

Turn the transceiver power OFF when connecting the HM-168LWP.

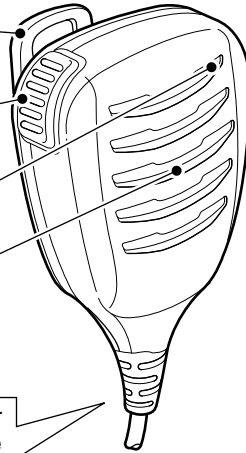

Attachment

Attach the connector of the speaker-microphone into the [SP MIC] jack on the transceiver and tighten the screws with fingers.

NOTE: Use only your fingers instead of tools to tighten the screws.

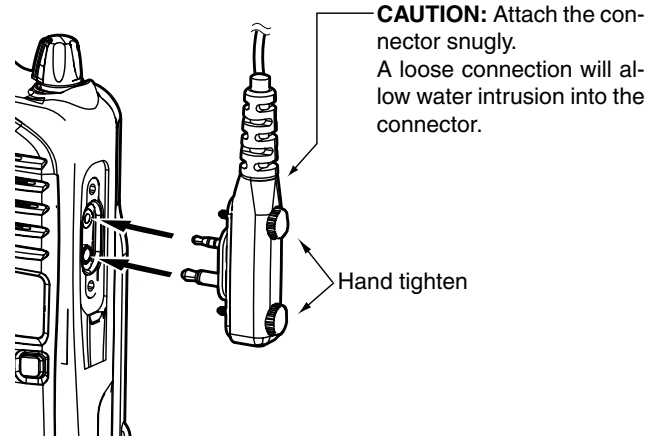

CAUTION: Attach the connector snugly. A loose connection will allow water intrusion into the connector.

Hand tighten

NEVER immerse the connector in water. If the connector becomes wet, be sure to dry it BEFORE attaching it to the transceiver.

NOTE: The microphone is located as shown in the diagram above. To maximize the readability of your transmitted signal (voice), hold the microphone approximately 5 to 10 cm from your mouth, and speak in a normal voice level.

IMPORTANT: Keep the [SP MIC] jack cover attached to the transceiver when the speaker-microphone is not in use.

◇ BATTERY PACK

Battery pack	Voltage	Capacity	Battery life*
BP-232WP	7.4 V	2250 mAh (min.) 2300 mAh (typ.)	17.5 hrs.

* When the power save function is turned ON, and the operating periods are calculated under the following conditions;
TX : RX : standby = 5 : 5 : 90
(Operating period depends on the alkaline cells used.)

◇ CHARGERS

- **BC-119N** DESKTOP CHARGER + **AD-106** CHARGER ADAPTER + **BC-145S** AC ADAPTER
For rapid charging of battery packs. A power adapter is supplied with the charger depending on versions.
Charging time: Approximately 3.5 hours for the BP-232WP
- **BC-121N** MULTI-CHARGER + **AD-106** CHARGER ADAPTER (6 pcs.) + **BC-157S** AC ADAPTER
For rapid charging of up to 6 battery packs (six AD-106's are required) simultaneously. A power adapter should be purchased separately.
Charging time: Approximately 3.5 hours for the BP-232WP
- **BC-160** DESKTOP CHARGER + **BC-145S** AC ADAPTER
For rapid charging of battery packs. A power adapter is supplied with the charger depending on versions.
Charging time: Approximately 3.5 hours for the BP-232WP

- **BC-171** DESKTOP CHARGER + **BC-147S** AC ADAPTER

A power adapter is supplied with the charger depending on versions.

Charging time: Approximately 11.5 hours when BP-232WP is attached.

◇ DC CABLES

- **CP-23L** CIGARETTE LIGHTER CABLE
Allows charging of the battery pack through a 12 V cigarette lighter socket. (For BC-160/BC-171/BC-119N)
- **OPC-515L/OPC-656** DC POWER CABLES
Allows charging of the battery pack using a 13.8 V power source instead of the power adapter.
OPC-515L: For BC-160/BC-171/BC-119N
OPC-656 : For BC-121N

◇ BELT CLIPS

- **MB-93** SWIVEL BELT CLIP
- **MB-94** BELT CLIP
Exclusive alligator-type belt clip. The same as supplied with the transceiver.
- **MB-96N/96F** LEATHER BELT HANGER

◇ **OPTIONAL UNITS**

- **UT-96R** 5-TONE UNIT
- **UT-108R** DTMF DECODER UNIT
Provides pager and code squelch capabilities.
- **UT-109R /UT-110R*** VOICE SCRAMBLER UNITS
Non-rolling type (UT-109R)/Rolling type (UT-110R)* voice scrambler unit provides higher communication security.
*You can use the UT-110R as Non-rolling type.
- **UT-124R** MAN DOWN UNIT
Provides measure of safety when working in a hazardous environment, etc.

◇ **OTHER OPTIONS**

- **HM-168LWP** SPEAKER-MICROPHONE
Combination speaker-microphone that provides convenient operation while hanging the transceiver from your belt.
- **FA-SC25V/FA-SC55V/**
FA-SC25U/FA-SC57U/FA-SC62V/FA-SC63V ANTENNAS
FA-SC25V: 136–150 MHz FA-SC55V: 150–174 MHz
FA-SC25U: 400–430 MHz FA-SC57U: 430–470 MHz
FA-SC62V: 150–160 MHz FA-SC63V: 155–165 MHz
- **FA-SC56VS/FA-SC57VS/FA-SC73US** STUBBY ANTENNAS
FA-SC56VS: 150–162 MHz FA-SC57VS: 160–174 MHz
FA-SC73US: 450–490 MHz
- **FA-SC61VC/FA-SC61UC** CUT ANTENNAS
FA-SC61VC: 136–174 MHz FA-SC61UC: 380–520 MHz

Some options may not be available in some countries. Ask your dealer for details.

Approved Icom optional equipment is designed for optimal performance when used with an Icom transceiver. Icom is not responsible for the destruction or damage to an Icom transceiver in the event the Icom transceiver is used with equipment that is not manufactured or approved by Icom.

8

COUNTRY CODE LIST

ISO 3166-1

	Country	Codes		Country	Codes
1	Austria	AT	18	Liechtenstein	LI
2	Belgium	BE	19	Lithuania	LT
3	Bulgaria	BG	20	Luxembourg	LU
4	Croatia	HR	21	Malta	MT
5	Czech Republic	CZ	22	Netherlands	NL
6	Cyprus	CY	23	Norway	NO
7	Denmark	DK	24	Poland	PL
8	Estonia	EE	25	Portugal	PT
9	Finland	FI	26	Romania	RO
10	France	FR	27	Slovakia	SK
11	Germany	DE	28	Slovenia	SI
12	Greece	GR	29	Spain	ES
13	Hungary	HU	30	Sweden	SE
14	Iceland	IS	31	Switzerland	CH
15	Ireland	IE	32	Turkey	TR
16	Italy	IT	33	United Kingdom	GB
17	Latvia	LV			

Count on us!

< Intended Country of Use >

AT BE CY CZ DK EE
FI FR DE GR HU IE
IT LV LT LU MT NL
PL PT SK SI ES SE
GB IS LI NO CH BG
RO TR HR

A-6999D-1EU-②

Printed in Japan

© 2012-2015 Icom Inc.

Printed on recycled paper with soy ink.

Icom Inc.

1-1-32 Kamiminami, Hirano-ku, Osaka 547-0003, Japan