

**HF/50 MHz TRANSCEIVER**  
**IC-7700**  
**Instruction Manual**

---

## FOREWORD

---

Thank you for making the IC-7700 your radio of choice. We hope you agree with Icom's philosophy of "technology first." Many hours of research and development went into the design of your IC-7700.

### ◇ **FEATURES**

- *Ultimate receiver performance: third-order intercept (IP3) of +40 dBm (HF bands only)*
- *Built-in Baudot RTTY and PSK31 modulator/demodulator and direct PC keyboard connection capability for RTTY and PSK31 operations without a PC*
- *High resolution spectrum scope — center frequency and fixed frequency modes, plus mini-scope displays*

---

## IMPORTANT

---

**READ THIS INSTRUCTION MANUAL CAREFULLY** before attempting to operate the transceiver.

**SAVE THIS INSTRUCTION MANUAL.** This manual contains important safety and operating instructions for the IC-7700.

---

## EXPLICIT DEFINITIONS

---

WORD	DEFINITION
⚠ <b>DANGER!</b>	Personal death, serious injury or an explosion may occur.
⚠ <b>WARNING!</b>	Personal injury, fire hazard or electric shock may occur.
<b>CAUTION</b>	Equipment damage may occur.
<b>NOTE</b>	Recommended for optimum use. No risk of personal injury, fire or electric shock.

---

## TRADEMARKS

---

Icom, Icom Inc. and the Icom logo are registered trademarks of Icom Incorporated (Japan) in Japan, the United States, the United Kingdom, Germany, France, Spain, Russia, Australia, New Zealand, and/or other countries.

### **FOR CLASS B UNINTENTIONAL RADIATORS**

This equipment has been tested and found to comply with the limits for a Class B digital device, pursuant to part 15 of the FCC Rules. These limits are designed to provide reasonable protection against harmful interference in a residential installation. This equipment generates, uses and can radiate radio frequency energy and, if not installed and used in accordance with the instructions, may cause harmful interference to radio communications. However, there is no guarantee that interference will not occur in a particular installation. If this equipment does cause harmful interference to radio or television reception, which can be determined by turning the equipment off and on, the user is encouraged to try to correct the interference by one or more of the following measures:

- Reorient or relocate the receiving antenna.
- Increase the separation between the equipment and receiver.
- Connect the equipment into an outlet on a circuit different from that to which the receiver is connected.
- Consult the dealer or an experienced radio/TV technician for help.

---

## PRECAUTIONS

---

**⚠ DANGER HIGH RF VOLTAGE! NEVER** attach an antenna or internal antenna connector during transmission. This may result in an electrical shock or burn.

**⚠ WARNING! NEVER** operate the transceiver with a headset or other audio accessories at high volume levels. Hearing experts advise against continuous high volume operation. If you experience a ringing in your ears, reduce the volume or discontinue use.

**⚠ WARNING! NEVER** operate or touch the transceiver with wet hands. This may result in an electric shock or damage to the transceiver.

**⚠ WARNING! NEVER** let metal, wire or other objects protrude into the transceiver or into connectors on the rear panel. This may result in an electric shock.

**⚠ WARNING!** Immediately turn the transceiver power OFF and remove the power cable if it emits an abnormal odor, sound or smoke. Contact your Icom dealer or distributor for advice.

**CAUTION: NEVER** put the transceiver in any unstable place (such as on a slanted surface or vibrated place). This may cause injury and/or damage to the transceiver.

**CAUTION: NEVER** put the transceiver's rear panel side down after lifting up the transceiver by holding rack mounting handle. This may scratch the surface of the place or damage the connectors on the transceiver's rear panel.

**CAUTION: NEVER** change the internal settings of the transceiver. This may reduce transceiver performance and/or damage to the transceiver.

In particular, incorrect settings for transmitter circuits, such as output power, idling current, etc., might damage the expensive final devices.

The transceiver warranty does not cover any problems caused by unauthorized internal adjustment.

**CAUTION: NEVER** block any cooling vents on the top, rear or bottom of the transceiver.

**CAUTION: NEVER** expose the transceiver to rain, snow or any liquids.

**CAUTION: NEVER** install the transceiver in a place without adequate ventilation. Heat dissipation may be reduced, and the transceiver may be damaged.

**CAUTION:** The transceiver weighs approximately 22.5 kg (50 lb). Always have two people available to carry, lift or turn over the transceiver.

**CAUTION:** The line-voltage receptacle must be near the transceiver and must be easily accessible. Avoid extension cords.

**DO NOT** use harsh solvents such as benzene or alcohol when cleaning, as they can damage the transceiver's surfaces.

**DO NOT** push the PTT switch when you don't actually desire to transmit.

**DO NOT** use or store the transceiver in areas with temperatures below  $\pm 0^{\circ}\text{C}$  ( $+32^{\circ}\text{F}$ ) or above  $+50^{\circ}\text{C}$  ( $+122^{\circ}\text{F}$ ).

**DO NOT** place the transceiver in excessively dusty environments or in direct sunlight.

**DO NOT** place the transceiver against walls or putting anything on top of the transceiver. This may overheat the transceiver.

Always place unit in a secure place to avoid inadvertent use by children.

**BE CAREFUL!** If you use a linear amplifier, set the transceiver's RF output power to less than the linear amplifier's maximum input level, otherwise, the linear amplifier will be damaged.

**BE CAREFUL!** touch the transceiver top cover when transmitting continuously for long periods of time. The top cover may be hot.

Use Icom microphones only (supplied or optional). Other manufacturers' microphones have different pin assignments, and connection to the IC-7700 may damage the transceiver or microphone.

The LCD display may have cosmetic imperfections that appear as small dark or light spots. This is not a malfunction or defect, but a normal characteristic of LCD displays.

During maritime mobile operation, keep the transceiver and microphone as far away as possible from the magnetic navigation compass to prevent erroneous indications.

Turn [I/O] switch (on the rear panel) OFF and/or disconnect the AC power cable from the AC outlet when you will not use the transceiver for long period of time.

### ***For U.S.A. only***

**CAUTION:** Changes or modifications to this device, not expressly approved by Icom Inc., could void your authority to operate this device under FCC regulations.

# SUPPLIED ACCESSORIES

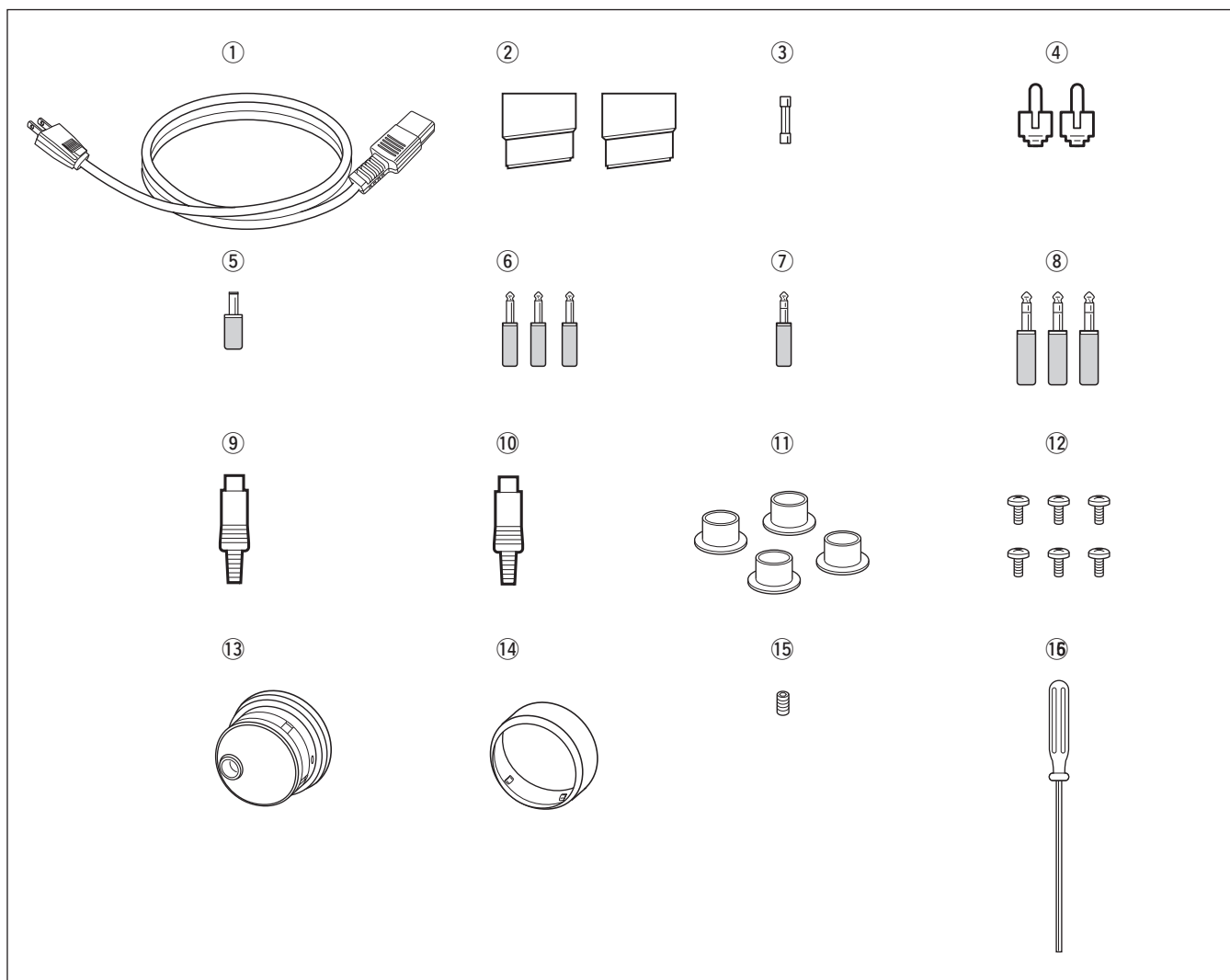

① AC power cable*	1
② Feet	1 pair
③ Spare fuse (FGB 2 A)	1
④ RCA plugs	2
⑤ DC plug	1
⑥ 2-conductor 1/8" plugs	3
⑦ 3-conductor 1/8" plugs	2
⑧ 3-conductor 1/4" plugs	3
⑨ ACC plugs (7-pin)	1
⑩ ACC plugs (8-pin)	1
⑪ Antenna connector caps	4
⑫ Side screws (without rack mounting handle) <sup>†</sup>	6
⑬ Main dial <sup>‡</sup>	1
⑭ Rubber cover for the Main dial <sup>‡</sup>	1
⑮ Main dial screw <sup>‡</sup>	1
⑯ Hexagonal wrench <sup>‡</sup>	1

\* May differ from that shown depending on the version.

<sup>†</sup> These screws are used when removing the rack mounting handles. See p.2-3 for the rack mounting handle detachment details.

<sup>‡</sup> See p.2-2 for the main dial attachment details.

---

# TABLE OF CONTENTS

---

<b>Section 1</b>	<b>PANEL DESCRIPTION</b>	
	■ Front panel .....	1-2
	■ Rear panel .....	1-12
	■ LCD display .....	1-14
	■ Screen menu arrangement .....	1-16
<b>Section 2</b>	<b>INSTALLATION AND CONNECTIONS</b>	
	■ Unpacking .....	2-2
	■ Main dial attachment .....	2-2
	■ Rack mounting handle detachment .....	2-3
	■ Selecting a location .....	2-3
	■ Grounding .....	2-4
	■ Antenna connection .....	2-4
	■ USB flash drive connection .....	2-4
	■ Required connections .....	2-5
	◇ Front panel .....	2-5
	◇ Rear panel .....	2-5
	■ Advanced connections .....	2-6
	◇ Front panel .....	2-6
	◇ Rear panel—1 .....	2-6
	◇ Rear panel—2 .....	2-7
	■ Linear amplifier connections .....	2-8
	◇ Connecting the IC-PW1/EURO .....	2-8
	◇ Connecting a non-Icom linear amplifier .....	2-8
	■ Transverter jack information .....	2-9
	■ FSK and AFSK connections .....	2-9
	◇ When using the ACC socket or the microphone connector .....	2-9
	■ Microphones (options) .....	2-10
	◇ SM-50 .....	2-10
	◇ SM-30 .....	2-10
	◇ HM-36 .....	2-11
	■ Microphone connector information .....	2-11
	■ Accessory connector information .....	2-12
<b>Section 3</b>	<b>BASIC OPERATIONS</b>	
	■ When first applying power (CPU resetting) .....	3-2
	■ Initial settings .....	3-2
	■ Selecting VFO/memory mode .....	3-3
	■ VFO selection .....	3-3
	◇ Selecting VFO-A/VFO-B .....	3-3
	◇ VFO equalization .....	3-3
	■ Selecting an operating band .....	3-4
	◇ Using the band stacking registers .....	3-4
	■ Frequency setting .....	3-5
	◇ Tuning with the main dial .....	3-5
	◇ Direct frequency entry with the keypad .....	3-5
	◇ Quick tuning step .....	3-6
	◇ Selecting “kHz” step .....	3-6
	◇ 1/4 tuning step function .....	3-6
	◇ Selecting 1 Hz step .....	3-7
	◇ Auto tuning step function .....	3-7
	■ Operating mode selection .....	3-8
	■ Volume setting .....	3-9
	■ RF gain adjustment .....	3-9
	■ Squelch level adjustment .....	3-9

---

# TABLE OF CONTENTS

---

■ Meter indication selection .....	3-10
◇ Multi-function digital meter .....	3-10
◇ Meter type selection .....	3-11
■ Voice synthesizer operation .....	3-11
■ Basic transmit operation .....	3-12
◇ Transmitting .....	3-12
◇ Microphone gain adjustment .....	3-12
◇ Drive gain adjustment .....	3-13
■ Band edge warning beep .....	3-13
◇ Programming the user band edge .....	3-14
<b>Section 4   RECEIVE AND TRANSMIT</b>	
■ Operating SSB .....	4-2
◇ Convenient functions for receive .....	4-2
◇ Convenient functions for transmit .....	4-3
◇ About 5 MHz band operation (USA version only) .....	4-3
■ Operating CW .....	4-4
◇ Convenient functions for receive .....	4-4
◇ Convenient functions for transmit .....	4-5
◇ About CW reverse mode .....	4-5
◇ About CW pitch control .....	4-5
◇ CW side tone function .....	4-5
◇ APF (Audio Peak Filter) operation .....	4-6
■ Electronic keyer functions .....	4-7
◇ Memory keyer screen .....	4-8
◇ Editing a memory keyer .....	4-9
◇ Contest number set mode .....	4-10
◇ Keyer set mode .....	4-11
■ Operating RTTY (FSK) .....	4-13
◇ Convenient functions for receive .....	4-14
◇ About RTTY reverse mode .....	4-14
◇ Twin peak filter .....	4-14
◇ Functions for the RTTY decoder display .....	4-15
◇ Setting the decoder threshold level .....	4-15
◇ RTTY memory transmission .....	4-16
◇ Automatic transmission/reception setting .....	4-16
◇ Editing RTTY memory .....	4-17
◇ RTTY decode set mode .....	4-18
◇ Data saving .....	4-20
■ Operating PSK .....	4-21
◇ Convenient functions for receive .....	4-22
◇ About BPSK and QPSK modes .....	4-22
◇ Functions for the PSK decoder display .....	4-23
◇ Setting the decoder threshold level .....	4-23
◇ PSK memory transmission .....	4-24
◇ Automatic transmission/reception setting .....	4-24
◇ Editing PSK memory .....	4-25
◇ PSK decode set mode .....	4-26
◇ Data saving .....	4-28
■ Operating AM .....	4-29
◇ Convenient functions for receive .....	4-29
◇ Convenient functions for transmit .....	4-30
■ Operating FM .....	4-31
◇ Convenient functions for receive .....	4-31

---

# TABLE OF CONTENTS

---

	◇ Convenient functions for transmit .....	4-31
■	Repeater operation .....	4-32
	◇ Repeater access tone frequency setting .....	4-33
■	Tone squelch operation .....	4-34
■	Data mode (AFSK) operation .....	4-35
<b>Section 5</b>	<b>FUNCTIONS FOR RECEIVE</b>	
■	Spectrum scope screen .....	5-2
	◇ Center mode .....	5-2
	◇ Fixed mode .....	5-3
	◇ Mini scope screen display .....	5-4
	◇ Scope set mode .....	5-4
	◇ USB mouse operation .....	5-9
■	Preamplifier .....	5-10
■	Attenuator .....	5-10
■	RIT function .....	5-11
	◇ RIT monitor function .....	5-11
■	AGC function .....	5-12
	◇ Selecting the preset value .....	5-12
	◇ Adjusting the AGC time constant .....	5-12
	◇ Setting the AGC time constant preset value .....	5-12
■	Twin PBT operation .....	5-13
■	IF filter selection .....	5-14
	◇ IF filter selection .....	5-14
	◇ Filter passband width setting (except FM mode) .....	5-14
	◇ Roofing filter selection .....	5-15
	◇ DSP filter shape .....	5-15
	◇ Filter shape set mode .....	5-15
■	Noise blanker .....	5-16
	◇ NB set mode .....	5-17
■	Noise reduction .....	5-18
■	Dial lock function .....	5-18
■	Notch function .....	5-19
■	Digital selector .....	5-19
■	Audio scope screen .....	5-20
	◇ Audio scope set mode .....	5-21
■	Autotune function .....	5-22
<b>Section 6</b>	<b>FUNCTIONS FOR TRANSMIT</b>	
■	VOX function .....	6-2
	◇ Using the VOX function .....	6-2
	◇ Adjusting the VOX function .....	6-2
	◇ VOX set mode .....	6-2
■	Break-in function .....	6-3
	◇ Semi break-in operation .....	6-3
	◇ Full break-in operation .....	6-3
■	ΔTX function .....	6-4
	◇ ΔTX monitor function .....	6-4
■	Monitor function .....	6-4
■	Transmit filter width setting (SSB only) .....	6-5
■	Speech compressor (SSB only) .....	6-5
■	Split frequency operation .....	6-6
■	Quick split function .....	6-7
	◇ Split lock function .....	6-7

---

# TABLE OF CONTENTS

---

<b>Section 7</b>	<b>VOICE RECORDER FUNCTIONS</b>	
	■ Recording a QSO audio .....	7-2
	◇ To start or stop recording .....	7-2
	■ Recording quick operation .....	7-2
	◇ To start or stop recording .....	7-2
	■ Playing back recorded audio (QSO) .....	7-3
	◇ Basic playing .....	7-3
	◇ Operating while playing back .....	7-4
	■ Deleting recorded audio file .....	7-5
	■ Deleting recorded audio folder.....	7-5
	■ About digital voice recorder .....	7-6
	■ Recording a received audio (Short REC) .....	7-7
	◇ One-touch recording .....	7-7
	■ Playing back the recorded audio (Short REC) .....	7-7
	◇ Basic playing .....	7-7
	◇ One-touch playing .....	7-8
	■ Protect the recorded contents .....	7-8
	■ Erasing the recorded contents.....	7-8
	■ Recording a message for transmit .....	7-9
	◇ Recording .....	7-9
	◇ Confirming a message for transmit.....	7-9
	■ Programming a memory name .....	7-10
	■ Sending a recorded message .....	7-11
	◇ Single TX.....	7-11
	◇ Repeat TX .....	7-11
	◇ Transmit level setting .....	7-12
	■ Voice set mode .....	7-12
	■ Saving a voice memory into the memory device .....	7-15
	◇ Saving the received audio memory .....	7-15
	◇ Saving the TX memory .....	7-15
<b>Section 8</b>	<b>MEMORY OPERATION</b>	
	■ Memory channels .....	8-2
	■ Memory channel selection .....	8-2
	◇ Using the ▲ / ▼ keys .....	8-2
	◇ Using the keypad .....	8-2
	■ Memory channel programming .....	8-3
	◇ Programming in VFO mode .....	8-3
	◇ Programming in memory mode .....	8-3
	■ Frequency transfers .....	8-4
	◇ Transferring in VFO mode .....	8-4
	◇ Transferring in memory mode .....	8-4
	■ Memory list screen .....	8-5
	◇ Selecting a memory channel using the memory list screen .....	8-5
	◇ Confirming programmed memory channels .....	8-5
	■ Memory names .....	8-6
	◇ Editing (programming) memory names .....	8-6
	■ Memory clearing .....	8-6
	■ Memo pads.....	8-7
	◇ Writing frequencies and operating modes into memo pads .....	8-7
	◇ Calling up a frequency from a memo pad .....	8-7



---

# TABLE OF CONTENTS

---

<b>Section 9</b>	<b>SCANS</b>	
	■ Scan types .....	9-2
	■ Preparation .....	9-2
	■ Voice squelch control function .....	9-3
	■ Scan set mode .....	9-3
	■ Programmed scan operation .....	9-4
	■ $\Delta F$ scan operation .....	9-4
	■ Fine programmed scan/Fine $\Delta F$ scan .....	9-5
	■ Memory scan operation .....	9-6
	■ Select memory scan operation .....	9-6
	■ Setting select memory channels .....	9-7
	◇ Setting in scan screen .....	9-7
	◇ Setting in memory list screen .....	9-7
	◇ Erasing the select scan setting .....	9-7
	■ Tone scan .....	9-8
<b>Section 10</b>	<b>ANTENNA TUNER OPERATION</b>	
	■ Antenna connection and selection .....	10-2
	■ Antenna memory settings .....	10-3
	◇ Antenna type selection .....	10-3
	◇ Temporary memory .....	10-4
	◇ Antenna selection mode .....	10-4
	◇ Receive antenna I/O setting .....	10-5
	■ Antenna tuner operation .....	10-6
	◇ Tuner operation .....	10-6
	◇ If the tuner cannot tune the antenna .....	10-7
<b>Section 11</b>	<b>CLOCK AND TIMERS</b>	
	■ Time set mode .....	11-2
	■ Daily timer setting .....	11-3
	■ Setting sleep timer .....	11-4
	■ Timer operation .....	11-4
<b>Section 12</b>	<b>SET MODE</b>	
	■ Set mode description .....	12-2
	◇ Set mode operation .....	12-2
	◇ Screen arrangement .....	12-3
	■ Level set mode .....	12-4
	■ ACC set mode .....	12-7
	■ Display set mode .....	12-10
	■ Others set mode .....	12-12
	■ USB-Memory set menu .....	12-23
	◇ USB-Memory set screen arrangement .....	12-23
	◇ Save option set mode .....	12-24
	◇ Load option set mode .....	12-25
	■ File saving .....	12-26
	■ File loading .....	12-27
	■ Changing a file name .....	12-28
	■ Deleting a file .....	12-29
	■ Unmounting USB flash drive .....	12-29
	■ Formatting USB flash drive .....	12-30

---

# TABLE OF CONTENTS

---

<b>Section 13</b>	<b>MAINTENANCE</b>	
	■ Troubleshooting .....	13-2
	◇ Transceiver power .....	13-2
	◇ Transmit and receive .....	13-2
	◇ Scanning .....	13-3
	◇ Display .....	13-3
	◇ Format USB flash drive .....	13-3
	■ Main dial brake adjustment .....	13-3
	■ SWR reading .....	13-4
	■ Screen type and font selections .....	13-4
	■ Frequency calibration (approximate) .....	13-5
	■ Opening the transceiver's case .....	13-6
	■ Clock backup battery replacement .....	13-6
	■ Fuse replacement .....	13-7
	■ Resetting the CPU .....	13-7
	■ About protection indications .....	13-8
	■ Screen saver function .....	13-8
<b>Section 14</b>	<b>CONTROL COMMAND</b>	
	■ Remote jack (CI-V) information .....	14-2
	◇ CI-V connection example .....	14-2
	◇ Data format .....	14-2
	◇ Command table .....	14-3
	◇ Data contents description.....	14-10
<b>Section 15</b>	<b>SPECIFICATIONS AND OPTIONS</b>	
	■ Specifications .....	15-2
	◇ General .....	15-2
	◇ Transmitter .....	15-2
	◇ Receiver .....	15-3
	◇ Antenna tuner .....	15-3
	■ Options .....	15-4
<b>Section 16</b>	<b>UPDATING THE FIRMWARE</b>	
	■ General .....	16-2
	◇ Firmware confirmation .....	16-2
	■ Caution .....	16-2
	■ Preparation .....	16-3
	◇ Firmware and firm utility .....	16-3
	◇ File downloading .....	16-3
	■ Firmware update— USB flash drive .....	16-4
	■ Firmware update— PC .....	16-6
	◇ Connections .....	16-6
	◇ IP address setting .....	16-7
	◇ Updating from a PC .....	16-8

# PANEL DESCRIPTION

# Section 1

---

■ Front panel .....	1-2
■ Rear panel .....	1-12
■ LCD display .....	1-14
■ Screen menu arrangement .....	1-16

# 1 PANEL DESCRIPTION

## ■ Front panel

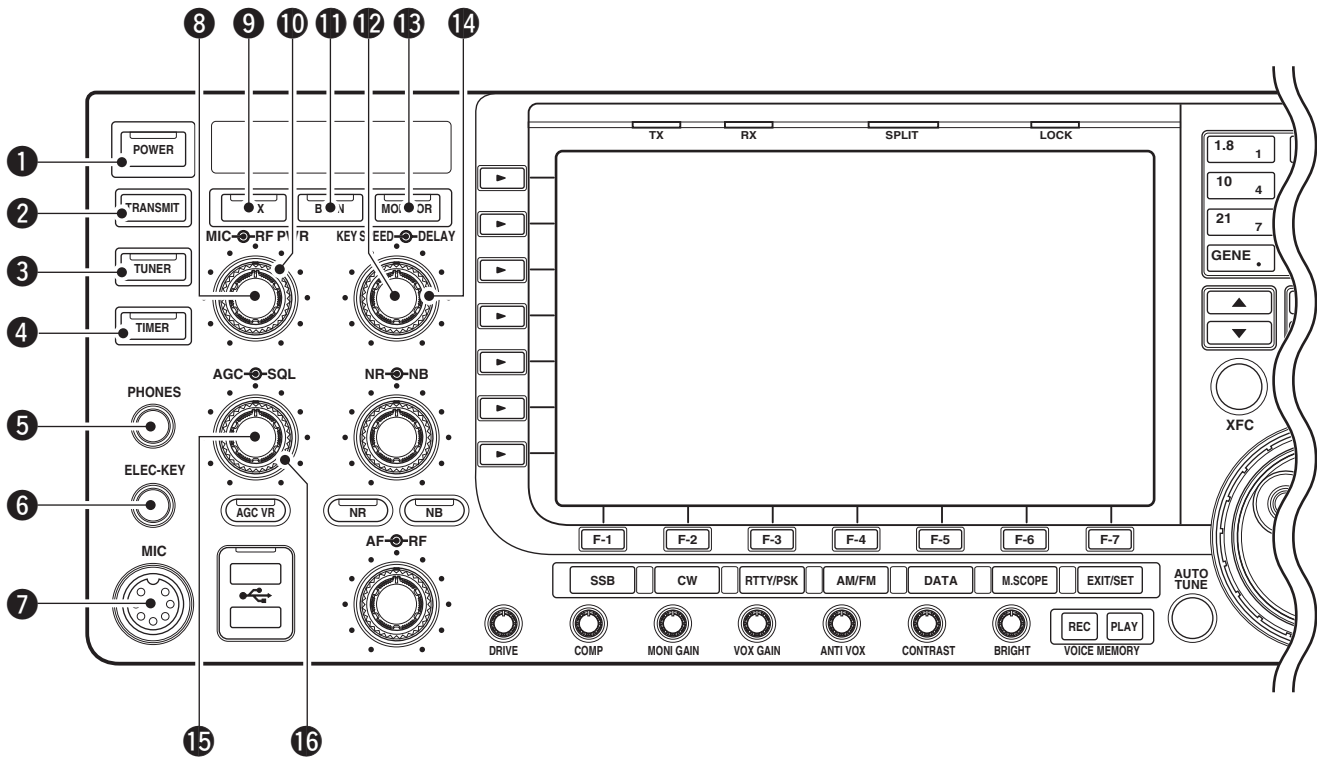

### 1 POWER SWITCH [POWER] (p. 3-2)

Turn the internal power supply ON first. The internal power supply switch is located on the rear panel. (p. 3-2)

- Push to turn the transceiver power ON.
  - The [POWER] indicator above this switch lights green when powered ON.
- Hold down for 1 second to turn the transceiver power OFF.
  - The [POWER] indicator lights orange when the transceiver is OFF when the internal power supply is switched ON.

### 2 TRANSMIT SWITCH [TRANSMIT]

Selects transmit or receive.

- The [TX] indicator lights red while transmitting and the [RX] indicator lights green when the squelch is open.

### 3 ANTENNA TUNER SWITCH [TUNER] (p. 10-6)

- Turns the internal antenna tuner ON or OFF (bypass) when pushed momentarily.
  - The [TUNER] indicator above this switch lights green when the tuner is turned ON, goes off when tuner is turned OFF (bypassed).
- Tunes the antenna tuner manually when held down for 1 second.
  - The [TUNER] indicator blinks red during manual tuning.
  - When the tuner cannot tune the antenna, the tuning circuit is automatically bypassed after 20 seconds.

### 4 TIMER SWITCH [TIMER] (p. 11-4)

- Turns the sleep or daily timer function ON or OFF.
  - The [TIMER] indicator above this switch lights green when the timer is in use.
- Selects the timer set mode when held down for 1 second.

### 5 HEADPHONE JACK [PHONES]

Accepts standard stereo headphones.

- Output power: 5 mW with an 8 Ω load.
- When headphones are connected, the internal speaker or connected external speaker does not function.

### 6 ELECTRONIC KEYS JACK [ELEC-KEY] (p. 2-5)

Accepts a paddle to activate the internal electronic keyer for CW operation.

- You can select internal electronic keyer, bug-key or straight key operation in keyer set mode. (p. 4-12)
- A straight key jack is located on the rear panel. See [CW KEY] on page 1-12.
- Keyer polarity (dot and dash) can be reversed in keyer set mode. (p. 4-12)
- A 4-channel memory keyer is available for your convenience. (p. 4-8)

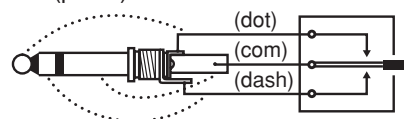

**7 MICROPHONE CONNECTOR [MIC]**

Accepts an optional microphone.  
 • See page 15-4 for appropriate microphones.  
 • See page 2-10 for microphone connector information.

**8 MIC GAIN CONTROL [MIC] (p. 3-12)**

Adjusts microphone input gain.  
 • The transmit audio tone in the SSB, AM and FM modes can be adjusted independently in set mode. (p. 12-5)

**✓ How to set the microphone gain.**

Set the [MIC] control so that the ALC meter occasionally moves up-scale during normal voice transmission, in the SSB, AM or FM mode.

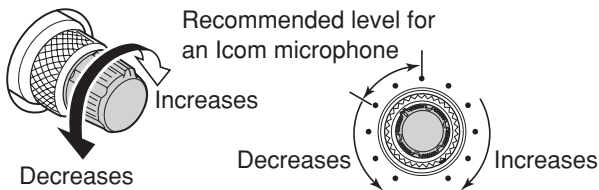

**9 VOX SWITCH [VOX]**

- ➔ Push to turn the VOX function ON or OFF during SSB, AM and FM mode operation. (p. 6-2)
- ➔ Hold down for 1 second to enter VOX set mode. (p. 6-2)

**✓ What is the VOX function?**

The VOX function (voice operated transmission) activates transmission without pushing the transmit switch or PTT switch when you speak into the microphone; then automatically returns to receive when you stop speaking.

**10 RF POWER CONTROL [RF PWR] (p. 3-12)**

Continuously varies the RF output power from a minimum of 5 W\* to a maximum of 200 W\*.  
 \*AM mode: 5 W to 50 W

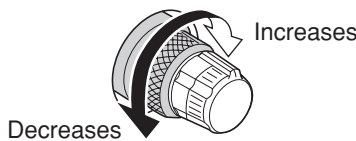

**11 BREAK-IN SWITCH [BK-IN]**

Push to turn the break-in function ON (semi-break-in, full-break-in) or OFF during CW mode operation. (p. 6-3)

**✓ What is the break-in function?**

The break-in function switches transmit and receive with CW keying. Full break-in (QSK) can monitor the receive signal between CW dots and dashes.

**12 ELECTRONIC CW KEYSER SPEED CONTROL [KEY SPEED] (p. 4-4)**

Adjusts keying speed for the internal electronic CW keyer.  
 • 6 wpm (minimum) to 48 wpm (maximum) is the adjustable range.

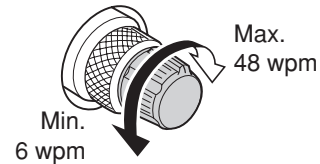

**13 MONITOR SWITCH [MONITOR] (p. 6-4)**

Monitors your transmitted IF signal.  
 • The CW sidetone functions regardless of [MONITOR] switch setting in the CW mode.  
 • The [MONITOR] indicator above this switch lights green while the function is activated.

**14 BREAK-IN DELAY CONTROL [DELAY] (p. 6-3)**

Adjusts the transmit-to-receive switching delay time for CW semi-break-in operations.

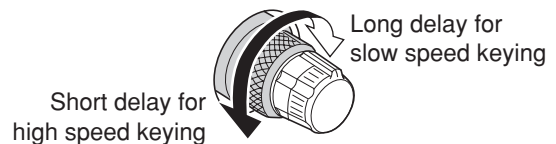

**15 AGC CONTROL [AGC] (p. 5-12)**

Adjusts the continuously-variable AGC circuit time constant.  
 • To use [AGC] control, push [AGC VR] ([AGC VR] indicator lights).

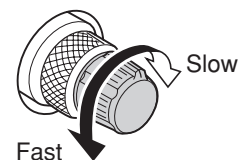

**16 SQUELCH CONTROL [SQL]**

(outer control; p. 3-9)  
 Adjusts the squelch threshold level. The squelch mutes noise output from the speaker (closed condition) when no signal is received.  
 • The squelch is particularly effective for FM. It is also available in other modes.  
 • The 11 to 12 o'clock position is recommended for the most effective use of the [SQL] control.

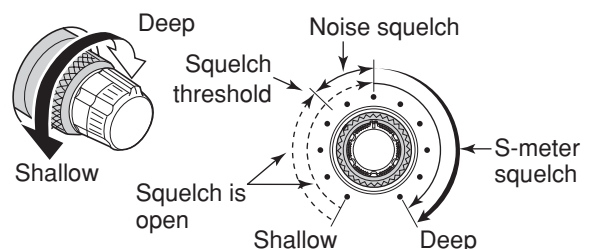

■ Front panel (continued)

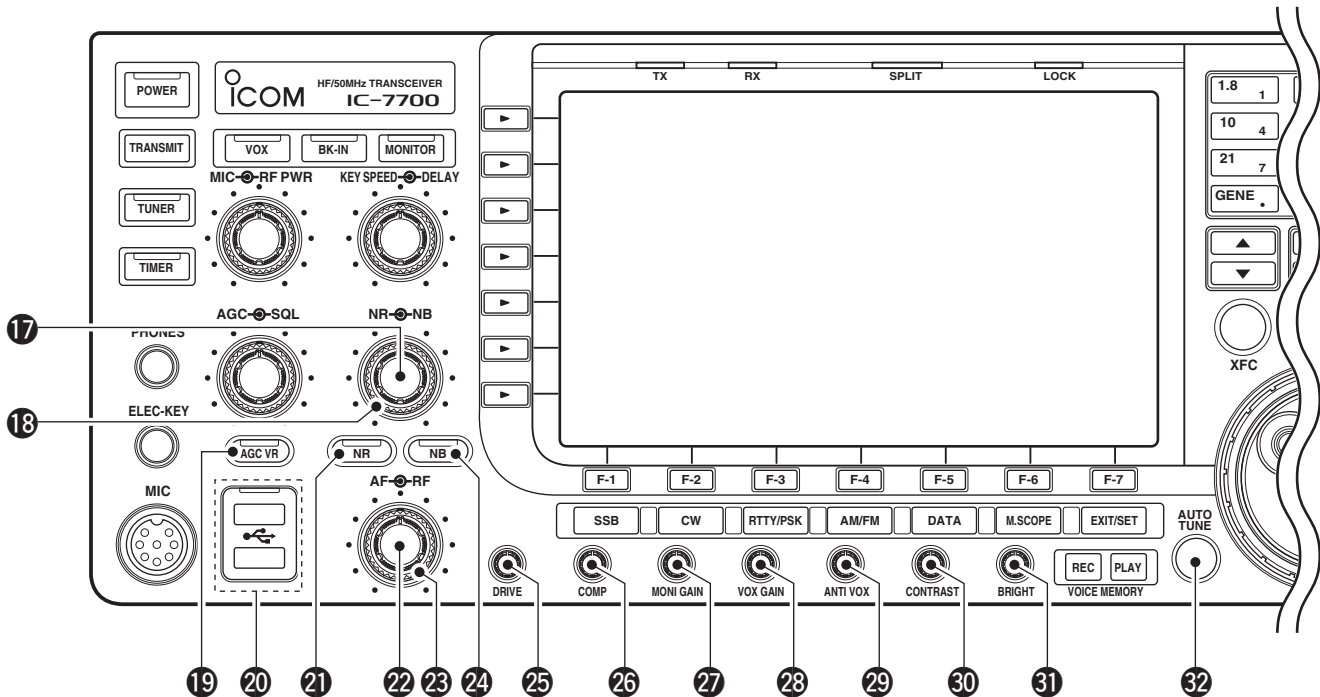

**17 NOISE REDUCTION LEVEL CONTROL [NR]**  
 (inner control; p. 5-18)  
 Adjusts the DSP noise reduction level when the noise reduction function is in use. Set for maximum readability.

- To use this control, push **NR**.

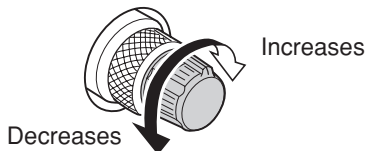

**18 NOISE BLANKER CONTROL [NB]**  
 (outer control; p. 5-17)  
 Adjust the noise blanker threshold level.

- To use this control, push **NB**.

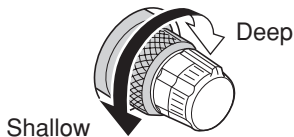

**19 AGC VOLUME SWITCH [AGC VR]** (p. 5-12)  
 ➔ Push to toggle [AGC] control usage ON or OFF.  
 • Use [AGC] control to set the AGC time constant, when switched ON.  
 • The [AGC VR] indicator above this switch lights green when the control is ON.  
 ➔ Turns the AGC function OFF when held down for 1 second.

**20 USB (Universal Serial Bus) CONNECTOR [USB]**  
 (p. 2-4)

- ➔ Insert USB flash drive\* for both reading and storing a wide variety of the transceiver's information and data.
  - The indicator above the connectors lights or blinks when the transceiver reads or writes to the memory data.
  - An unmount operation should be performed before removing the USB flash drive\* (p.12-29).
- ➔ Connects a PC keyboard for RTTY and PSK31 operations.
  - USB keyboards\* are supported.

\*: A USB flash drive or USB keyboard is not supplied by Icom.

**About the [USB] connector:**

- Supported only USB flash drive, keyboard, mouse or hub.
- **KEEP** the transceiver power OFF when connecting or disconnecting a USB keyboard, mouse or hub.
- **DO NOT** connect the following devices:
  - Two or more the same kind of USB devices. (Example: Two USB hubs or two USB mice)
  - Multimedia adapter
  - USB HDD
  - Larger than 32 GB USB flash drives
  - Bluetooth® keyboard or mouse.

**21 NOISE REDUCTION SWITCH [NR]** (p. 5-18)  
 Push to switch DSP noise reduction ON or OFF.  
 • The [NR] indicator above this switch lights green when the function is activated.

**22 AF CONTROL [AF]** (inner control; p. 3-9)  
 Varies the audio output level of the speaker or headphones.

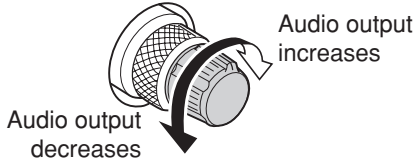

**23 RF GAIN CONTROL [RF]** (outer control; p. 3-9)  
 Adjusts the RF gain level.  
 While rotating the RF gain control, you may hear noise. This comes from the DSP unit and does not indicate a malfunction.

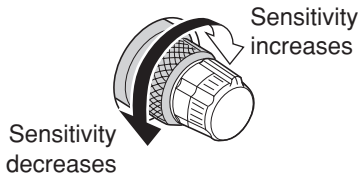

**24 NOISE BLANKER SWITCH [NB]** (p. 5-17)  
 Switches the noise blanker ON or OFF when pushed. The noise blanker reduces pulse-type noise such as that generated by automobile ignition systems. This function cannot be used in the FM mode, or on non-pulse-type noise.  
 • The [NB] indicator above this switch lights green while the function is activated.  
 Enters the blanking-width set mode when held down for 1 second.

**25 DRIVE GAIN CONTROL [DRIVE]** (p. 3-13)  
 Adjusts the transmitter level at the driver stage. Active in all modes (other than the SSB mode with [COMP] OFF).

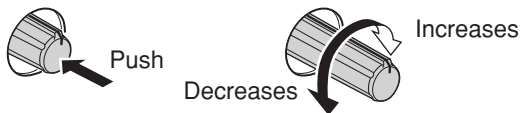

**26 COMPRESSION LEVEL CONTROL [COMP]** (p. 6-5)  
 Adjusts the speech compression level in SSB.

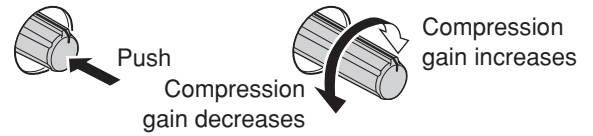

**27 MONITOR GAIN CONTROL [MONI GAIN]** (p. 6-4)  
 Adjusts the transmit IF signal monitor level.

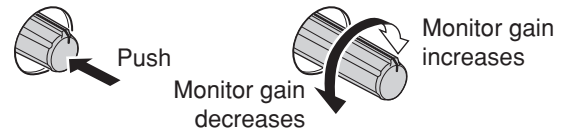

**28 VOX GAIN CONTROL [VOX GAIN]** (p. 6-2)  
 Adjusts the transmit and receive switching threshold level for VOX operation.

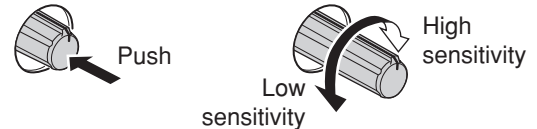

**29 ANTI VOX CONTROL [ANTI VOX]** (p. 6-2)  
 Adjusts the VOX sensitivity to the speaker audio, to prevent unwanted VOX activation.



**30 LCD CONTRAST CONTROL [CONTRAST]**  
 Adjusts the LCD contrast.

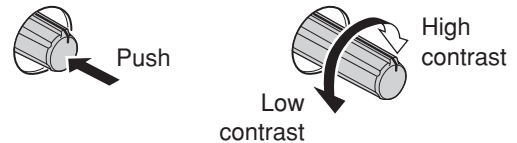

**31 LCD BRIGHTNESS CONTROL [BRIGHT]**  
 Adjusts the LCD brightness.



**32 AUTOMATIC TUNING SWITCH [AUTOTUNE]** (p. 5-22)

Turns the automatic tuning function ON or OFF in the CW and AM modes.

**IMPORTANT!**

When receiving a weak signal, or receiving a signal with interference, the automatic tuning function may tune the receiver to an undesired signal.

## ■ Front panel (continued)

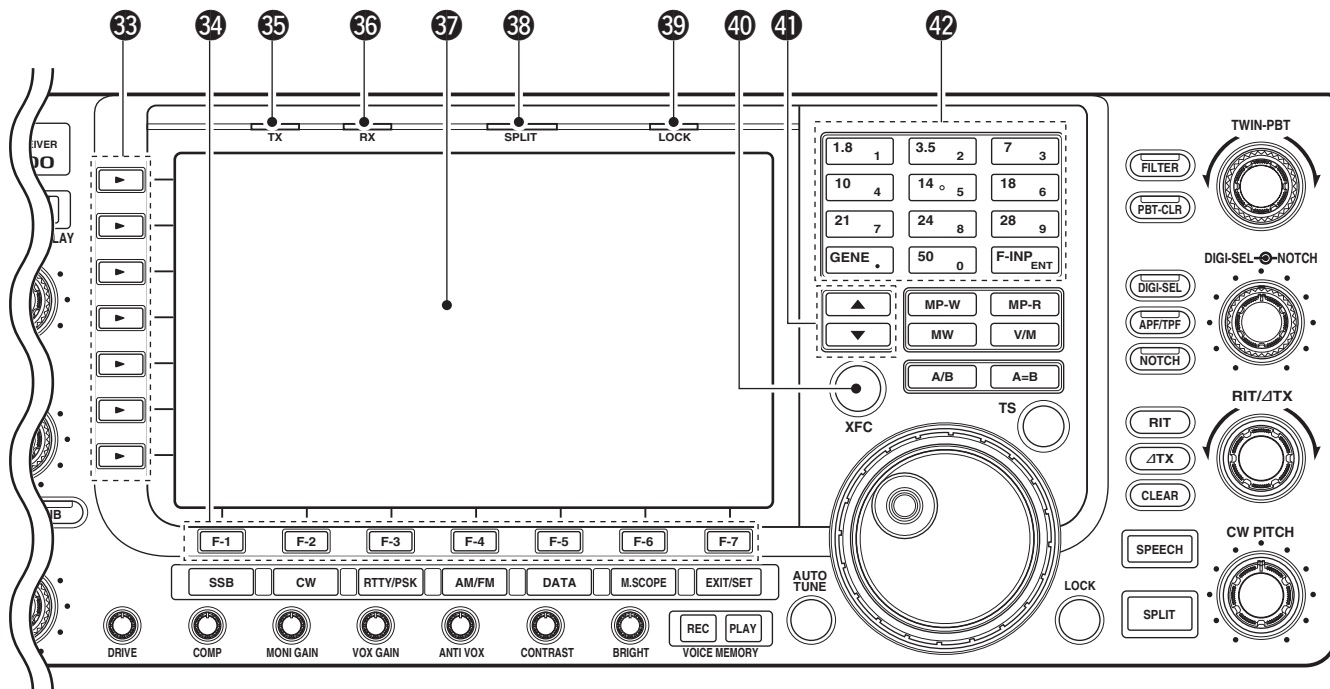

### 33 MULTI-FUNCTION SWITCHES

Push to select the functions indicated in the LCD display to the right of these switches.

- Functions vary depending on the operating condition.

#### MF1 (MULTI-FUNCTION 1 SWITCH)

**ANT**  
1

- ➔ Selects the antenna connector from ANT1, ANT2, ANT3 and ANT4 when pushed. (p. 10-2)
- ➔ Displays the antenna selection memory when held down for 1 second.
  - When the receive antenna is activated, the antenna connected to [ANT4] is used for receive only.

▨ When a transverter is in use, this [ANT] does not function and 'TRV' appears.

#### MF2 (MULTI-FUNCTION 2 SWITCH)

**METER**  
Po

- ➔ Selects the RF power (Po), SWR, ALC, COMP, Vd or Id metering functions during transmit. (p. 3-10)
- ➔ Switches the multi-function digital meter ON or OFF when held down for 1 second. (p. 3-10)

#### MF3 (MULTI-FUNCTION 3 SWITCH)

**P. AMP**  
1

- ➔ Selects one of 2 receive RF preamps or bypasses them. (p. 5-10)
  - "P. AMP1" activates 10 dB preamp.
  - "P. AMP2" activates 16 dB high-gain preamp.
- ➔ Turns the preamp function OFF when held down for 1 second. (p. 5-10)

#### ✓ What is the preamp?

The preamp amplifies signals in the receiver front end to improve S/N ratio and sensitivity. Select "P. AMP1" or "P. AMP2" when receiving weak signals.

#### MF4 (MULTI-FUNCTION 4 SWITCH)

**ATT**  
OFF

- ➔ Selects a 6 dB, 12 dB or 18 dB attenuator when pushed. (p. 5-10)
- ➔ Turns the attenuator function OFF when held down for 1 second. (p. 5-10)

#### ✓ What is the attenuator?

The attenuator prevents a desired signal from being distorted when very strong signals are near the desired frequency, or when very strong electromagnetic fields, such as from a broadcasting station, are near your location.



**MF5 (MULTI-FUNCTION 5 SWITCH)**



- Activates and selects a fast, mid or slow AGC time constant when pushed. (p. 5-12)
  - In the FM mode, only “FAST” is available.
- Selects the AGC set mode when held down for 1 second. (p. 5-12)

The AGC time constant can be set between 0.1 and 8.0 seconds (depending on the mode), or turned OFF. When the AGC is “OFF,” the S-meter does not function.

**✓ What is the AGC?**

The AGC controls the receiver gain to produce a constant audio output level, even when the received signal strength varies dramatically. Select “FAST” for tuning and then select “MID” or “SLOW,” depending on the receiving condition.

**MF6 (MULTI-FUNCTION 6 SWITCH)**



- Turns the speech compressor ON or OFF in the SSB mode. (p. 6-5)
- Switches the compression between narrow, mid or wide when held down for 1 second.

**✓ What is the speech compressor?**

The speech compressor compresses the transmitter audio input to increase the average audio output level, to increase talk power. This function is effective for long-distance communication or when propagation conditions are poor.



- Turns the 1/4-speed tuning function ON or OFF in the SSB data, CW, RTTY and PSK modes. (p. 3-6)
  - 1/4 function sets dial rotation to 1/4 of normal speed for fine tuning.



- Switches between the tone encoder, tone squelch function and no-tone operation when pushed in the FM mode. (pp. 4-33, 4-34)
- Selects the tone set mode when held down for 1 second in the FM mode. (pp. 4-33, 4-34)

**MF7 (MULTI-FUNCTION 7 SWITCH)**



- Switches the voice squelch control function ON or OFF; useful for scanning. (p. 9-3)

**34 LCD FUNCTION SWITCHES [F-1] – [F-7]**

Push to select the function indicated in the LCD display above these switches.
 

- Functions vary, depending on the operating condition.

**35 TRANSMIT INDICATOR [TX]**

Lights red while transmitting.

**36 RECEIVE INDICATOR [RX]**

Lights green while receiving a signal and when the squelch is open.

**37 LCD FUNCTION DISPLAY (p. 1-14)**

Shows the operating frequency, function switch menus, spectrum scope screen, memory list screen, set mode settings, etc.

**38 SPLIT OPERATION INDICATOR [SPLIT]**

Lights during split frequency operation.

**39 LOCK INDICATOR [LOCK] (p. 5-18)**

Lights when the dial lock function is activated.

**40 TRANSMIT FREQUENCY CHECK SWITCH [XFC] (p. 6-6)**

Monitors the transmit frequency (including  $\Delta$ TX frequency offset) when held down during split frequency operation.

- While pushing this switch, the transmit frequency can be changed with the main dial, keypad, memo pad or / switches.
- When the split lock function is turned ON, pushing [XFC] cancels the dial lock function. (p. 6-7)

**41 MEMORY UP/DOWN SWITCHES / (p. 8-2)**

Push to select the desired memory channel.
 

- Memory channels can be selected both in VFO and memory modes.

**42 KEYPAD**

- Pushing a key selects the operating band. (p. 3-4)
  - selects the general coverage band.
- Pushing the same key 2 or 3 times calls up other stacked frequencies in the band. (p. 3-4)
  - Icom’s triple band stacking register memorizes 3 frequencies in each band.
- After pushing , enters a frequency or memory channel. Pushing or / is necessary to end the entry. (pp. 3-5, 8-2)
  - To enter 14.195 MHz, push .

## ■ Front panel (continued)

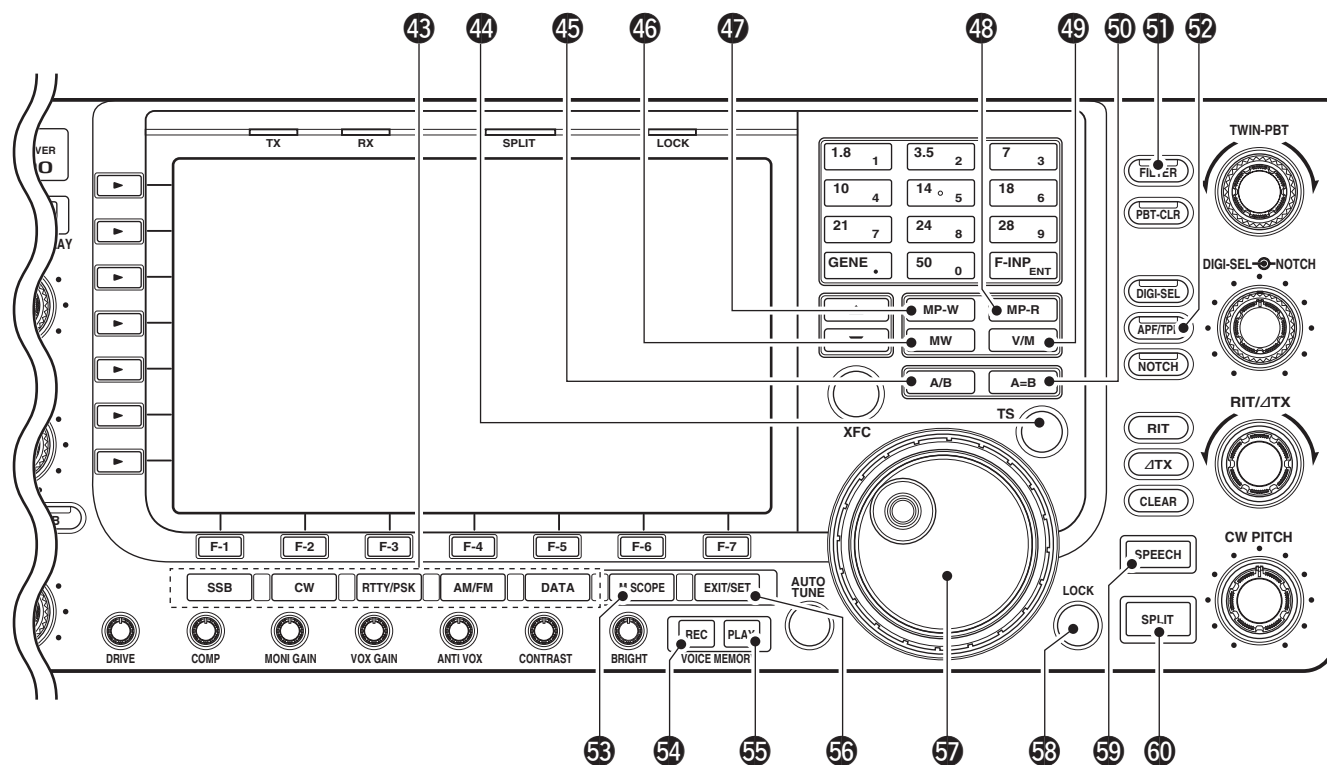

### 43 MODE SWITCHES

Selects the desired mode. (p. 3-8)

- Announces selected mode via the speech synthesizer. (p. 12-15)

**SSB** Selects USB and LSB modes alternately.

**CW** Selects CW and CW-R (CW reverse) modes alternately.

**RTTY/PSK** ➔ Switches between RTTY and PSK mode.  
 ➔ Switches RTTY and RTTY-R (RTTY reverse) mode when held down for 1 second in RTTY mode.  
 ➔ Switches PSK and PSK-R (PSK reverse) mode when held down for 1 second in PSK mode.

**AM/FM** Selects AM and FM modes alternately.

**DATA** ➔ Selects SSB, AM or FM data mode (USB-D, LSB-D, AM-D, FM-D) when pushed in SSB, AM or FM mode, respectively.  
 ➔ Switches D1, D2 and D3 when held down for 1 second.

### 44 QUICK TUNING SWITCH [TS]

➔ Turns the quick tuning step ON or OFF. (p. 3-6)

- While the quick tuning indicator, “▼,” is displayed above the frequency display, the frequency can be changed in programmed kHz steps.
- 0.1, 1, 5, 9, 10, 12.5, 20 and 25 kHz steps are available for each operating mode independently.
- ➔ When the quick tuning step is OFF, hold down for 1 second to turn the 1 Hz tuning step ON or OFF. (p. 3-7)
- ➔ When the quick tuning step is ON, hold down for 1 second to enter quick tuning step set mode. (p. 3-6)

### 45 VFO SELECT SWITCH [A/B]

Push to select between VFO-A and VFO-B.

- Switches between transmit frequency and receive frequency when the split frequency function is ON. (p. 6-6)

### 46 MEMORY WRITE SWITCH [MW] (p. 8-3)

Stores the selected readout frequency and operating mode into the displayed memory channel when held down for 1 second.

- This function is available both in VFO and memory modes.

- 47 MEMO PAD-WRITE SWITCH** **MP-W** (p. 8-7)  
 Programs the displayed readout frequency and operating mode into a memo pad.
- The 5 most recent entries remain in memo pads.
  - The memo pad capacity can be expanded from 5 to 10 in set mode. (p. 12-15)
- 48 MEMO PAD-READ SWITCH** **MP-R** (p. 8-7)  
 Each push calls up a frequency and operating mode in a memo pad. The 5 (or 10) most recently programmed frequencies and operating modes can be recalled, starting from the most recent.
- The memo pad capacity can be expanded from 5 to 10 in set mode. (p. 12-15)
- 49 VFO/MEMORY SWITCH** **V/M**  
 ➔ Switches the selected readout operating mode between the VFO and memory when pushed. (pp. 3-3, 8-2)  
 ➔ Transfers the memory contents to VFO when held down for 1 second. (p. 8-4)
- 50 VFO EQUALIZING SWITCH** **A=B** (p. 3-3)  
 Transfers the displayed VFO frequency (VFO-A or VFO-B) to the undisplayed VFO frequency (VFO-B or VFO-A) when held down for 1 second.
- 51 FILTER SWITCH** **FILTER** (p. 5-14)  
 ➔ Selects one of 3 IF filter settings.  
 ➔ Enters the filter set screen when held down for 1 second.
- 52 AUDIO PEAK FILTER/TWIN PEAK FILTER SWITCH** **APF/TPF**  
**During CW mode operation** (p. 4-6)  
 ➔ Push to turn the audio peak filter ON or OFF.  
 • “APF” appears when audio peak filter is in use.  
 ➔ Hold down for 1 second to select the APF pass-band width from WIDE, MID and NAR or from 320, 160 and 80 Hz depending on APF type setting.
- During RTTY mode operation** (p. 4-14)  
 ➔ Push to turn the twin peak filter ON or OFF.  
 • “TPF” appears when twin peak filter is in use.
- 53 MINI SPECTRUM SCOPE SWITCH** **M.SCOPE** (p. 5-4)  
 ➔ Push to turn the mini spectrum scope screen ON or OFF.  
 • The mini spectrum scope screen can be displayed with another screen, such as memory or set mode screen, simultaneously.  
 ➔ Hold down for 1 second to turn ON the spectrum scope screen.
- 54 VOICE MEMORY RECORD SWITCH** **REC**  
 ➔ Push to record the previous received signal for the preset time period. (p. 7-7)  
 • The preset time period can be set in voice set mode. (p. 7-13)  
 ➔ Hold down for 1 second to record a QSO (Communication) audio onto a memory device. (p. 7-2)  
 • Hold down this switch for 1 second to stop recording.
- 55 VOICE MEMORY PLAYBACK SWITCH** **PLAY** (p. 7-4)  
 ➔ Plays back the previously recorded audio for the preset time period when pushed.  
 ➔ Plays back all of the previously recorded audio when held down for 1 second.
- 56 EXIT/SET SWITCH** **EXIT/SET**  
 ➔ Push to exit, or return to the previous screen display during spectrum scope, memory, scan or set mode screen display.  
 ➔ Displays set mode menu screen when held down for 1 second.
- 57 MAIN DIAL**  
 Changes the displayed frequency, selects set mode setting, etc.
- 58 LOCK SWITCH** **[LOCK]** (p. 5-18)  
 Push to switch the dial lock function ON or OFF.
- 59 SPEECH SWITCH** **SPEECH** (p. 3-11)  
 ➔ Push to announce the S-meter indication and the selected frequency.  
 ➔ The selected operating mode is additionally announced when held down for 1 second.
- 60 SPLIT SWITCH** **SPLIT** (p. 6-6)  
 ➔ Turns the split function ON or OFF when pushed.  
 ➔ Turns the split function ON. When held down for 1 second in non-FM modes, transfers the unselected VFO's readout frequency to the selected VFO's readout and sets the unselected VFO to transmit VFO. (Quick split function)  
 • The offset frequency is shifted from the selected VFO frequency in FM mode. (p. 12-13)  
 • The quick split function can be turned OFF using set mode. (p. 12-13)  
 ➔ Turns the split function ON and shifts the unselected VFO frequency after inputting an offset.

■ Front panel (continued)

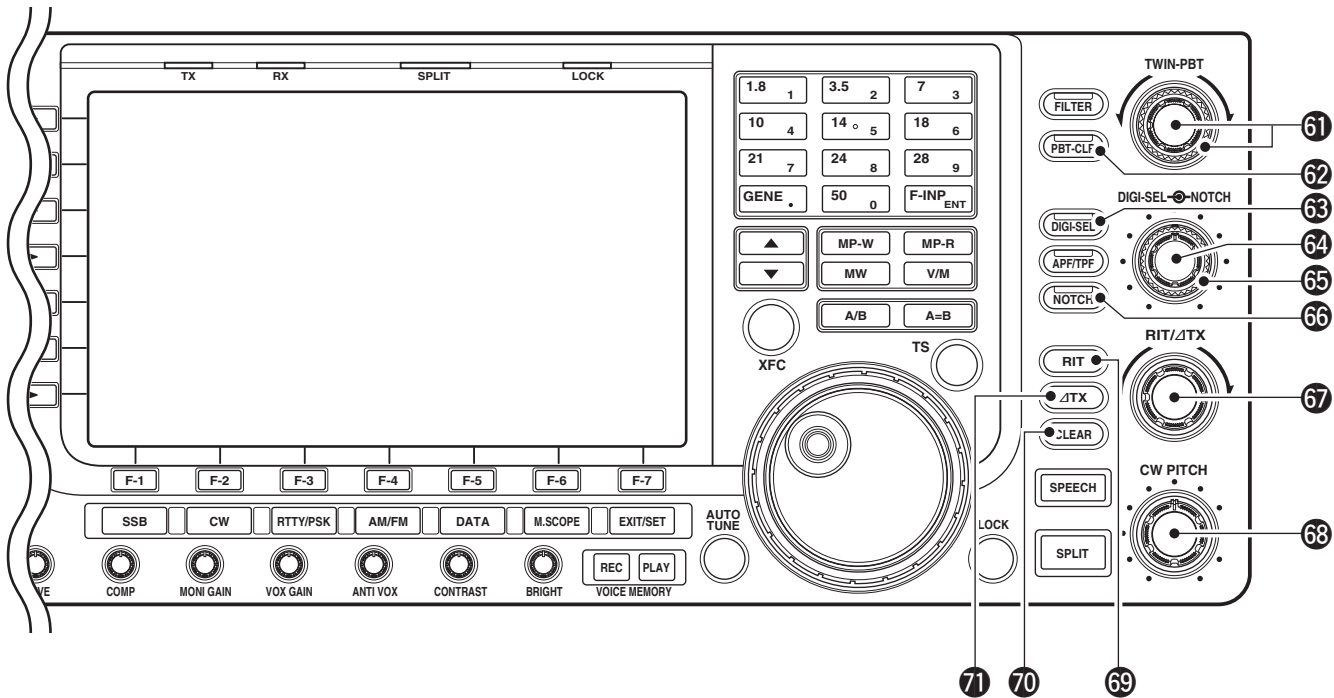

**61 PASSBAND TUNING CONTROLS [TWIN-PBT]**

(p. 5-13)

Adjusts the receiver’s IF filter “passband width” via the DSP.

- Passband width and shift frequency are displayed in the multi-function display.
- Hold down (PBT-CLR) for 1 second to clear the PBT settings.
- The PBT is adjustable in 50 Hz steps in the SSB/CW/RTTY/PSK modes, and 200 Hz in the AM mode. In this time, the shift value changes in 25 Hz steps in the SSB/CW/RTTY/PSK modes, and 100 Hz in the AM mode.
- These controls function as an IF shift control.

✓ **What is the PBT control?**

The PBT function electronically modifies the IF passband width to reject interference. This transceiver uses the DSP circuit for the PBT function.

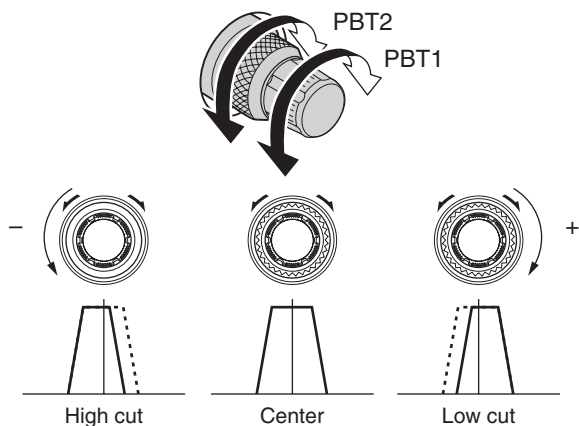

**62 PBT CLEAR SWITCH (PBT-CLR)** (p. 5-13)

Clears the PBT settings when held down for 1 second.

- The [PBT-CLR] indicator above this switch lights when PBT is in use.

**63 DIGITAL RF SELECTOR SWITCH (DIGI-SEL)**

(p. 5-19)

Turns the digital RF selector ON or OFF.

- The [DIGI-SEL] indicator lights green when the pre-selector is in use.

**64 DIGITAL RF SELECTOR CONTROL [DIGI-SEL]**

(p. 5-18)

Adjusts the digital RF selector center frequency.

- The control can be reassigned as the audio peak filter adjustment (p. 12-15)

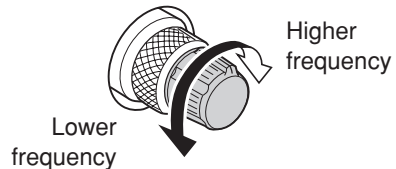

**65 MANUAL NOTCH FILTER CONTROL [NOTCH]**

(outer control; p. 5-19)

Varies the notch frequency of the manual notch filter to reject an interfering signal while the manual notch function is ON.

- Notch filter center frequency:
  - SSB : -1060 Hz to 4040 Hz
  - CW : CW pitch freq. + 2540 Hz to CW pitch freq. -2540 Hz
  - AM : -5100 Hz to 5100 Hz

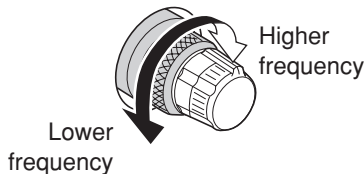

**66 NOTCH SWITCH [NOTCH]** (p. 5-19)

- ➔ Switches the notch function between auto, manual and OFF in the SSB and AM modes.
- ➔ Turns the manual notch function ON or OFF when pushed in the CW, RTTY and PSK31 mode.
- ➔ Turns the auto notch function ON or OFF when pushed in FM mode.
  - “MN” appears when manual notch is in use.
  - “AN” appears when auto notch is in use.
- ➔ Switches the manual notch characteristics from wide, middle and narrow when held down for 1 second.

**✓ What is the notch function?**

The notch function is a narrow filter that eliminates unwanted CW or AM carrier tones while preserving the desired voice signal. The DSP circuit automatically adjusts the notch frequency to effectively eliminate unwanted tones.

**67 RIT/ $\Delta$ TX CONTROL [RIT/ $\Delta$ TX]** (pp. 5-11, 6-4)

Shifts the receive and/or transmit frequency without changing the transmit and/or receive frequency shown on the main VFO.

- Rotate the control clockwise to increase the frequency, or rotate the control counterclockwise to decrease the frequency. The RIT or  $\Delta$ TX functions must be ON.
- The shift frequency range is  $\pm 9.999$  kHz in 1 Hz steps (or  $\pm 9.99$  kHz in 10 Hz steps).

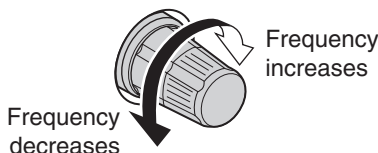

**68 CW PITCH CONTROL [CW PITCH]** (p. 4-5)

Shifts the received CW audio pitch and the CW side tone pitch without changing the operating frequency.

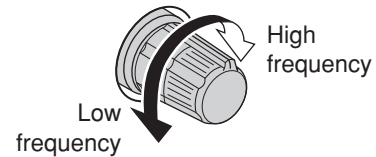

**69 RIT SWITCH [RIT]** (p. 5-11)

- ➔ Turns the RIT function ON or OFF when pushed.
  - Use [RIT/ $\Delta$ TX] control to vary the RIT frequency.
- ➔ Adds the RIT shift frequency to the operating frequency when held down for 1 second.

**✓ What is the RIT function?**

Receiver incremental tuning (RIT) shifts the receive frequency without shifting the transmit frequency.

This is useful for fine tuning stations calling you off-frequency or when you prefer to listen to slightly different-sounding voice characteristics, etc.

**70 CLEAR SWITCH [CLEAR]** (pp. 5-11, 6-4)

Clears the RIT/ $\Delta$ TX shift frequency when held down for 1 second or when pushed momentarily, depending on the quick RIT/ $\Delta$ TX clear function setting (p. 12-15).

**71  $\Delta$ TX SWITCH [ $\Delta$ TX]** (p. 6-4)

- ➔ Turns the  $\Delta$ TX function ON or OFF when pushed.
  - Use [RIT/ $\Delta$ TX] control to vary the  $\Delta$ TX frequency.
- ➔ Adds the  $\Delta$ TX shift frequency to the operating frequency when held down for 1 second.

**✓ What is the  $\Delta$ TX function?**

$\Delta$ TX shifts the transmit frequency without shifting the receive frequency. This is useful for simple split frequency operation in CW, etc.

## ■ Rear panel

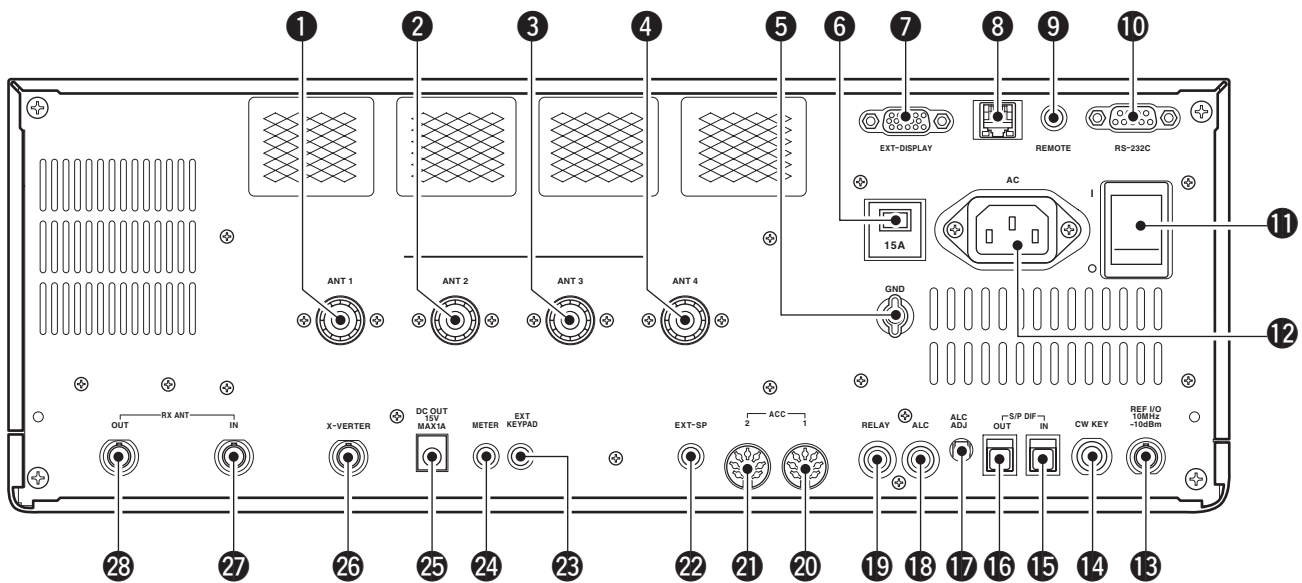

- 1 ANTENNA CONNECTOR 1 [ANT 1]** (p. 2-5)
- 2 ANTENNA CONNECTOR 2 [ANT 2]** (p. 2-5)
- 3 ANTENNA CONNECTOR 3 [ANT 3]** (p. 2-5)
- 4 ANTENNA CONNECTOR 4 [ANT 4]** (p. 2-5)  
Accept a 50 Ω antenna with a PL-259 plug connector.
- 5 GROUND TERMINAL [GND]** (p. 2-4)  
Connect this terminal to a ground to prevent electrical shocks, TVI, BCI and other problems.
- 6 CIRCUIT BREAKER**  
Cuts off the AC input when over-current occurs.
- 7 EXTERNAL DISPLAY TERMINAL [EXT-DISPLAY]** (p. 2-7)  
Connects to an external display monitor.  
• At least 800×600 pixel display is necessary.
- 8 ETHERNET CONNECTOR [LAN]** (p. 16-6)  
Connects to a PC through a LAN (Local Area Network).
- 9 CI-V REMOTE CONTROL JACK [REMOTE]** (pp. 2-6, 14-2)  
➤ Connects a PC via the optional CT-17 CI-V LEVEL CONVERTER for external control of the transceiver.  
➤ Used for transceiver operation with another Icom CI-V transceiver or receiver.

- 10 RS-232C TERMINAL [RS-232C]** (p. 2-6)  
Connects an RS-232C cable, D-sub 9-pin to connect the IC-7700 to a PC.  
Can be used to remotely control the IC-7700 without the optional CT-17, or for RTTY/PSK31 decoded signal output. The [RS-232C] interface is wired as a modem (DCE).
- 11 MAIN POWER SWITCH [I/O]** (p. 3-2)  
Turns the internal power supply ON or OFF.
- 12 AC POWER SOCKET [AC]** (p. 2-5)  
Connects the supplied AC power cable to an AC line-voltage receptacle.
- 13 REFERENCE SIGNAL INPUT/OUTPUT TERMINAL [REF I/O]**  
Inputs/outputs a 10 MHz reference signal.
- 14 STRAIGHT KEY JACK [CW KEY]** (p. 2-5)  
Accepts a straight key or external electronic keyer with 1/4 inch standard plug.  
• [ELEC-KEY] on the front panel can be used for a straight key or external electronic keyer. Deactivate the internal electronic keyer in keyer set mode. (p. 4-12)

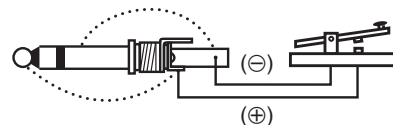

**15 S/P DIF INPUT TERMINAL [S/P DIF- IN]** (p. 2-7)

**16 S/P DIF OUTPUT TERMINAL [S/P DIF- OUT]**  
(p. 2-7)

Connects external equipment that supports S/P DIF input/output.

**17 ALC LEVEL ADJUSTMENT POT [ALC ADJ]**

Adjusts the ALC levels.

No adjustment is required when the ALC output level of a connected non-Icom linear amplifier is 0 to -4 V a DC.

**18 ALC INPUT JACK [ALC]** (p. 2-8)

Connects to the ALC output jack of a non-Icom linear amplifier.

**19 T/R CONTROL JACK [RELAY]** (p. 2-8)

Connects to ground when transmitting to control an external unit, such as a non-Icom linear amplifier.

**NOTE:** T/R control voltage and current must be lower than 16 V DC/0.5 A with Reed switching or 250 V AC/200 mA with MOSFET switching.

**20 ACCESSORY SOCKET 1 [ACC 1]**

**21 ACCESSORY SOCKET 2 [ACC 2]**

Enable connection of external equipment such as a linear amplifier, an automatic antenna selector/tuner, a TNC for data communications, and so on.

- See page 2-11 for socket information.

**22 EXTERNAL SPEAKER JACK [EXT-SP]** (p. 2-6)

Connects an external speaker (4–8 Ω), if desired.

**23 EXTERNAL KEYPAD JACK [EXT KEYPAD]**

(p. 2-7)

Connects an external keypad for direct voice memory or electronic keyer control.

Transceiver mute control line (both transmit and receive) is also supported.

**24 METER JACK [METER]** (p. 2-7)

Outputs a signal showing received signal strength, transmit output power, VSWR, ALC, speech compression, V<sub>D</sub> or I<sub>D</sub> level for external meter indication.

**25 DC OUTPUT JACK [DC OUT]** (p. 2-7)

Outputs a regulated 14 V DC (approximately) for external equipment. Connected in parallel with 13.8 V outputs of [ACC 1] and [ACC 2]. (maximum 1 A in total)



**26 TRANSVERTER CONNECTOR [X-VERTER]**

(p. 2-6)

External transverter input/output connector.

Activated by voltage applied to [ACC 2] pin 6, or when the transverter function is in use. (pp. 2-11)

**27 RECEIVE ANTENNA IN [RX ANT- IN]**

**28 RECEIVE ANTENNA OUT [RX ANT- OUT]**

Located between the transmit/receive switching circuit and receiver's RF stage.

Connects an external unit, such as preamplifier or RF filter, using BNC connectors, if desired.

When no external unit is connected, [RX ANT- IN] and [RX ANT- OUT] must be deactivated and shorted by the switching relay internally. This setting is available on the antenna set screen. (p. 10-5)

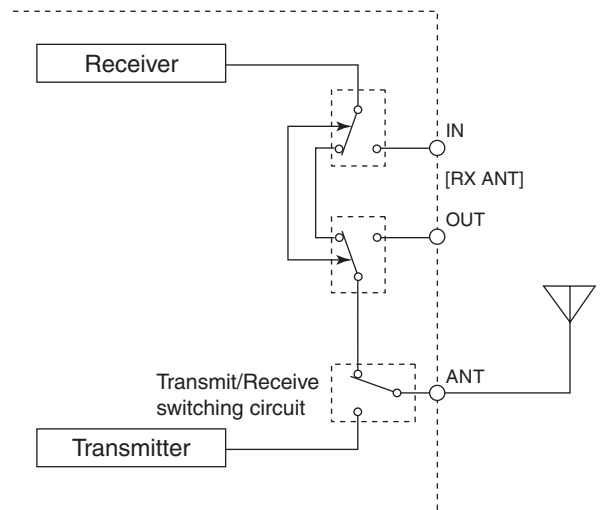

■ LCD display

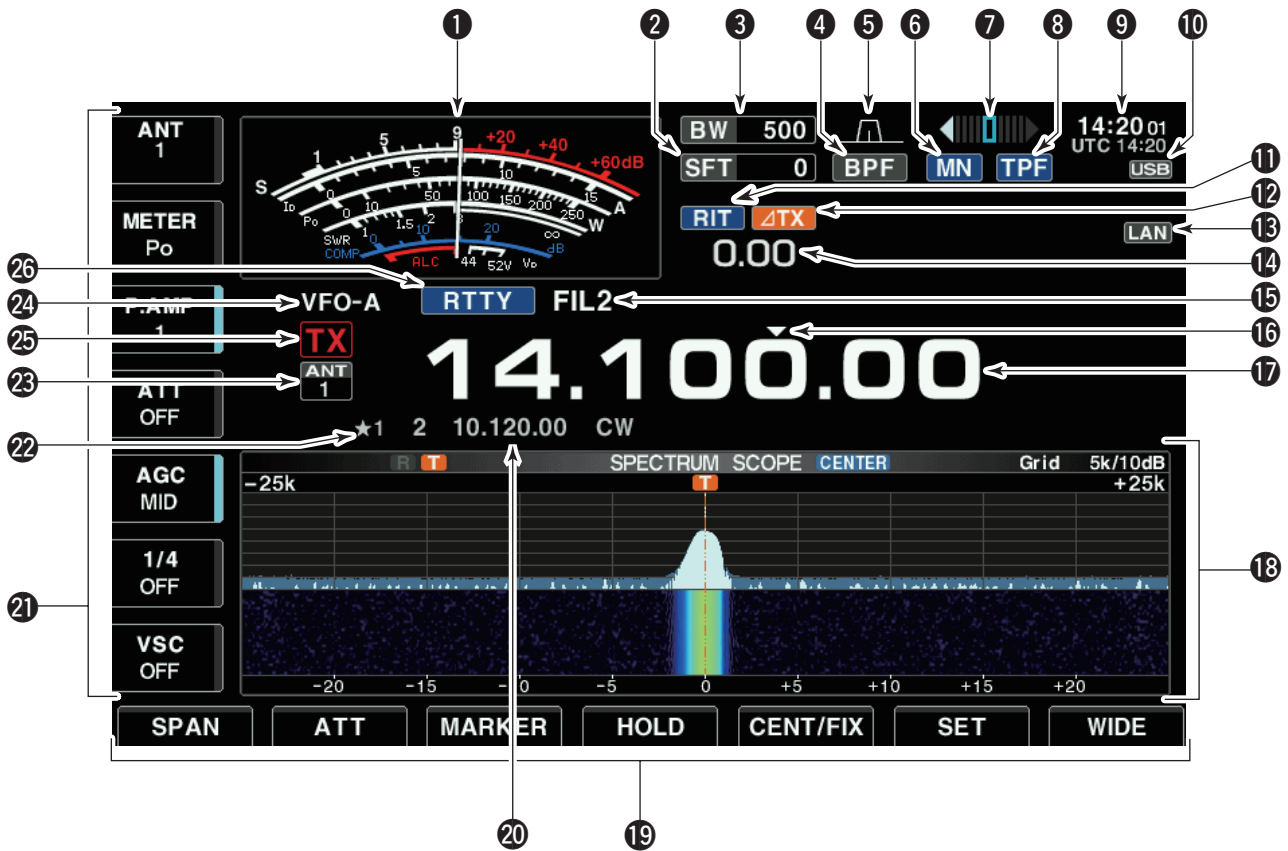

1 S/R/F METER (pp. 3-10, 3-11)

Shows the signal strength while receiving. Shows the relative output power, SWR, ALC or compression levels while transmitting.

- A total of 3 meter types are available.

- Standard meter



- Edgewise meter



- Bar meter

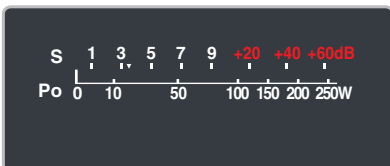

2 SHIFT FREQUENCY INDICATOR (p. 5-13)

Shows the shift frequency of the IF filter.

3 BAND WIDTH INDICATOR (p. 5-13)

Shows the passband width of the IF filter.

4 BANDPASS FILTER INDICATOR

Appears when the narrow filter (500 Hz or less) is selected during CW, RTTY or PSK31 operation.

5 PASSBAND WIDTH INDICATOR (p. 5-13)

Graphically displays the passband width for twin PBT operation and center frequency for IF shift operation.

6 NOTCH INDICATOR (p. 5-19)

➤ “MN” appears when the manual notch function is in use. This function is available in SSB, CW, RTTY, PSK and AM modes.

➤ “AN” appears when the auto notch function is in use. This function is available in SSB, AM and FM modes.

7 RTTY TUNING INDICATOR

Shows the tuning condition in RTTY mode.



- 8 APF/TPF INDICATOR**
- ➔ “**APF**” appears when the audio peak filter function is in use. This function is available in CW mode. (p. 4-6)
  - ➔ “**TPF**” appears when the twin peak filter function is in use. This function is available in RTTY mode. (p. 4-14)
- 9 CLOCK READOUT**  
Shows the current time. Local and UTC time can be indicated at the same time.
- 10 USB-MEMORY INDICATOR**  
Appears when USB flash drive is connected and blinks while reading or writing the USB flash drive.
- 11 RIT INDICATOR**  
Appears when RIT function is in use.
- 12 ΔTX INDICATOR**  
Appears when ΔTX function is in use.
- 13 LAN INDICATOR**  
Appears when the Remote station access the transceiver through the LAN. (An optional RS-BA1 is required.)
- 14 RIT/ΔTX SHIFT FREQUENCY INDICATOR**  
Shows the shift frequency for the RIT or ΔTX function.
- 15 IF FILTER INDICATOR** (p. 5-14)  
Shows the selected IF filter number.
- 16 QUICK TUNING INDICATOR** (p. 3-6)  
Appears when the quick tuning step function is in use.
- 17 FREQUENCY READOUTS**  
Shows the operating frequency.
- 18 MULTI-FUNCTION SCREEN**  
Shows the screens for the multi-function digital meter, spectrum scope, voice recorder, memory list, scan, memory keyer, RTTY decoder, PSK decoder, IF filter selection or set modes, etc.
- 19 LCD FUNCTION SWITCH GUIDE**  
Indicates the function of the LCD function switches ( **F-1** – **F-7** ).
- 20 MEMORY CHANNEL READOUTS**
- ➔ Shows the selected memory channel contents in VFO mode.
  - ➔ Shows the VFO contents in memory mode.
- 21 MULTI-FUNCTION SWITCH GUIDE**  
Indicates the function of the multi-function switches.
- 22 SELECT MEMORY CHANNEL INDICATOR** (p. 9-7)  
Indicates the displayed memory channel is set as a select memory channel.
- 23 SELECT ANTENNA INDICATOR**  
Indicates the selected antenna.
- 24 TX INDICATOR**
- ➔ “**TX**” appears while transmitting.
  - ➔ Indicates the frequency readout for transmit.
    - Appears on the sub readout when the split function is turned ON.
    - A TX indicator with dotted rectangle, “**TX**” is displayed, instead of the regular “**TX**” TX indicator, when a frequency outside of an amateur band frequency range is selected. This function can be turned OFF in set mode, if desired. (pp. 3-13, 12-12)
- 24 VFO/MEMORY CHANNEL INDICATOR** (p. 3-3)  
Indicates the VFO mode or selected memory channel number.
- 25 MODE INDICATOR**  
Shows the selected mode.

# 1 PANEL DESCRIPTION

## ■ Screen menu arrangement

The following screens can be selected from the start up screen. Choose the desired screen using the following chart.

Pushing **[EXIT/SET]** several times returns to the start up screen. See page 12-3 for set mode arrangement.

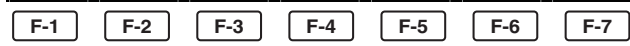

### • Spectrum scope screen (p. 5-2)

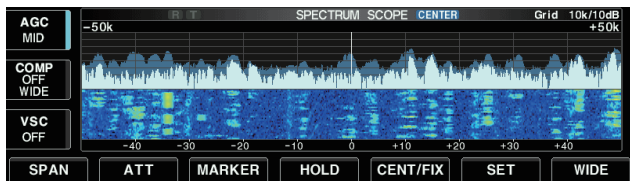

### • Voice recorder screen (p. 7-3)



### • Memory keyer screen (CW mode; p. 4-8)



### • RTTY decoder screen (RTTY mode; p. 4-13)



### • PSK31 decoder screen (PSK mode; p. 4-21)



### • Memory list screen (p. 8-5)

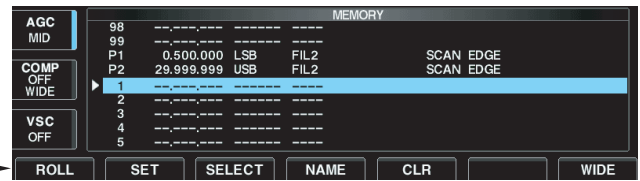

### • Scan screen (VFO mode; p. 9-4)

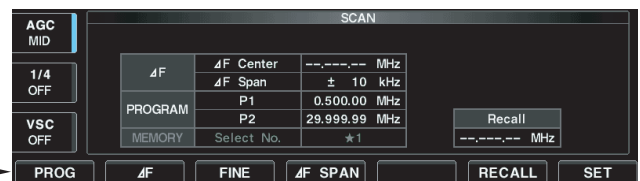

### • Scan screen (Memory mode; p. 9-6)

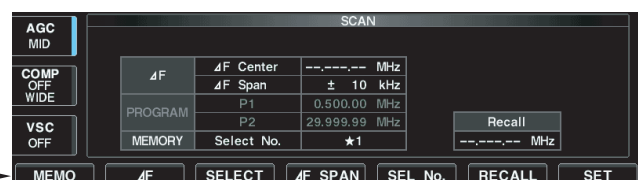

### • Audio scope screen (p. 5-20)

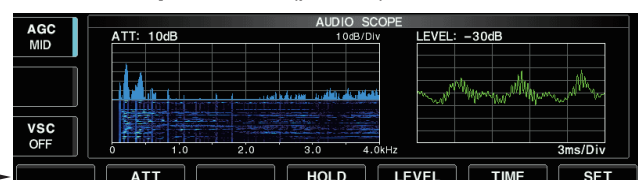

### • Set mode menu screen (p. 12-2)

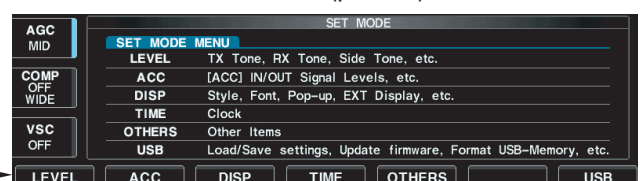

■ Unpacking .....	2-2
■ Main dial attachment .....	2-2
■ Rack mounting handle detachment .....	2-3
■ Selecting a location .....	2-3
■ Grounding .....	2-4
■ Antenna connection .....	2-4
■ USB flash drive connection .....	2-4
■ Required connections .....	2-5
◇ Front panel .....	2-5
◇ Rear panel .....	2-5
■ Advanced connections .....	2-6
◇ Front panel .....	2-6
◇ Rear panel—1 .....	2-6
◇ Rear panel—2 .....	2-7
■ Linear amplifier connections .....	2-8
◇ Connecting the IC-PW1/EURO .....	2-8
◇ Connecting a non-Icom linear amplifier .....	2-8
■ Transverter jack information .....	2-9
■ FSK and AFSK connections .....	2-9
◇ When using the ACC socket or the microphone connector .....	2-9
■ Microphones (options) .....	2-10
◇ SM-50 .....	2-10
◇ SM-30 .....	2-10
◇ HM-36 .....	2-11
■ Microphone connector information .....	2-11
■ Accessory connector information .....	2-12

 **CAUTION:** The transceiver weighs approximately 22.5 kg (50 lb). Always have two people available to carry, lift or turn over the transceiver.

## ■ Unpacking

After unpacking, immediately report any damage to the delivering carrier or dealer. Keep the shipping cartons.

For a description and a diagram of accessory equipment included with the IC-7700, see 'Supplied accessories' on page iii of this manual.

## ■ Main dial attachment

The main dial is shipped unattached to the transceiver to prevent possible damage to the dial shaft or rotary encoder during shipping. Please attach the dial as described below.

**CAUTION: NEVER** hold any controller knob(s), such as the main dial, when carrying or lifting the transceiver. This will damage the dial shaft or rotary encoder. Once attaching the rubber cover to the main dial, it's hard to remove. When you remove the rubber cover from main dial, be careful to lack your nails and/or damage to the transceiver.

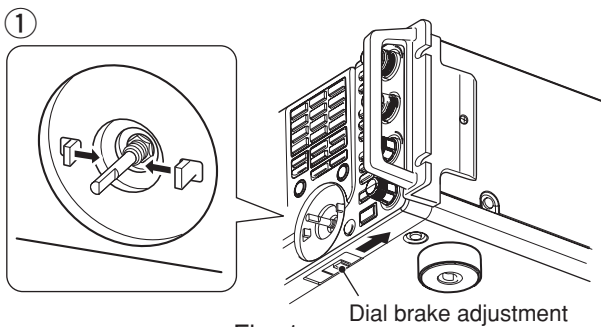

Fig. 1

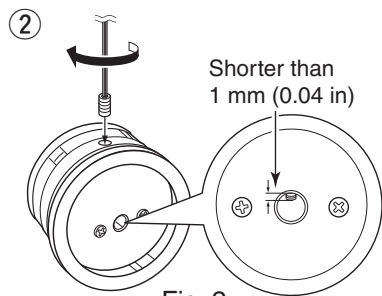

Fig. 2

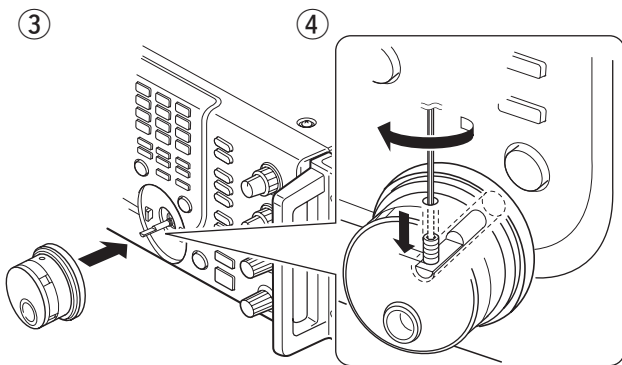

Fig. 3

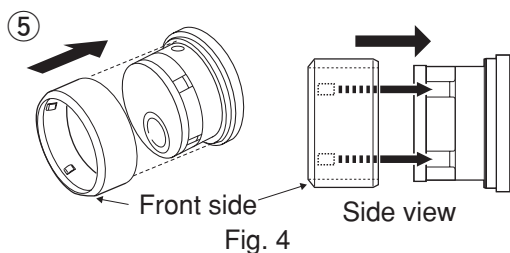
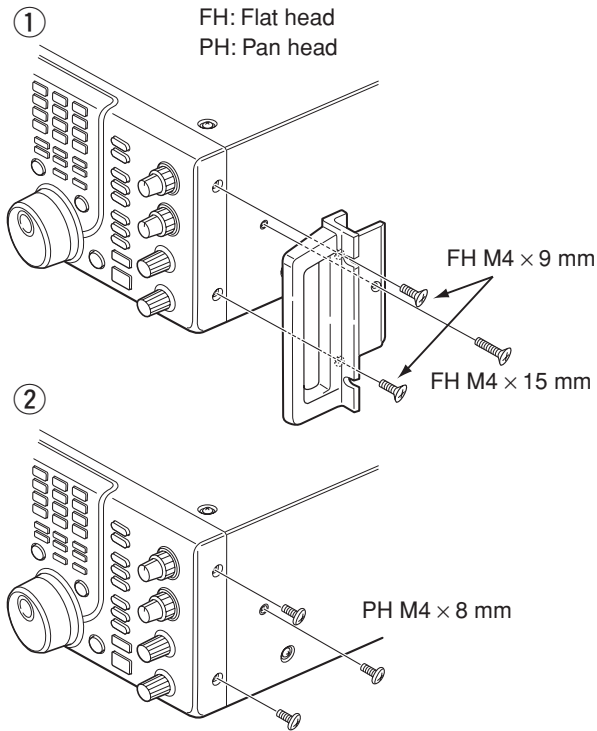

Fig. 4

- ① Slide the dial brake adjustment to the right position (Fig. 1).
  - The dial brakes move inward as shown.
- ② Insert the main dial set-screw into the screw hole of the main dial, then tighten the screw until the screw extends into the shaft hole out slightly using supplied hexagonal wrench (2 mm) (Fig. 2).
  - Be careful that the screw does not extend out more than 1 mm (0.04 in).
- ③ Attach the main dial as illustrated (Fig. 3).
  - Be careful to match the correct orientation of the flat face of the shaft and the screw hole of the dial knob.
- ④ Tighten the screw using supplied hexagonal wrench as illustrated (Fig. 3).
- ⑤ Install the rubber cover to the main dial (Fig. 4) little by little.
  - Be careful to match the correct position of the convex part of the rubber cover and the concave part of the dial knob.
  - Never install the rubber cover on the main dial by force. This may cause damage to the dial shaft or rotary encoder.
- ⑥ Then adjust the main dial brake as desired.

## ■ Rack mounting handle detachment



The rack mounting handles are supplied attached to the transceiver to stabilize the transceiver in the shock absorber material in the box. If you want to remove them, use the supplied screws as described below.

- ① Remove the six screws from the rack mounting handles on both side and remove the rack mounting handles.
- ② Tighten the supplied six screws (PH M4×8) on both sides of the front panel and side panel.

✓ **When re-packing and shipping the transceiver:** Attach the rack mounting handles using original screws when re-packing and shipping the transceiver at any time.

## ■ Selecting a location

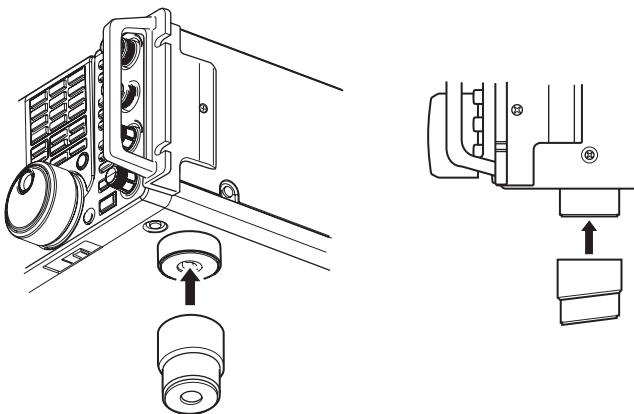

Select a location for the transceiver that allows adequate air circulation, free from extreme heat, cold, or vibrations, and away from TV sets, TV antenna elements, radios and other electromagnetic sources.

The base of the transceiver has adjustable feet for desktop use. Set the feet to one of two angles depending on your operating preference.

## ■ Grounding

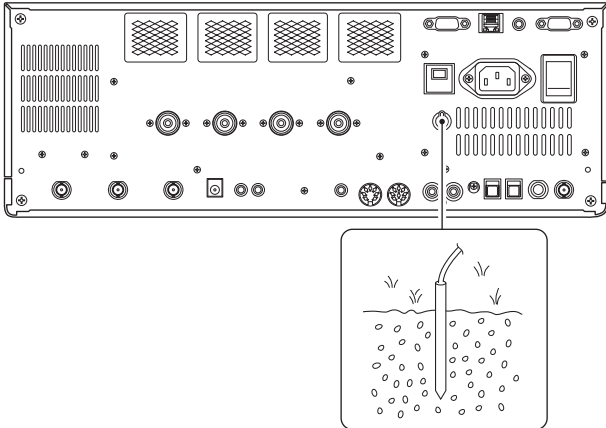

To prevent electrical shock, television interference (TVI), broadcast interference (BCI) and other problems, ground the transceiver through the GROUND terminal on the rear panel.

For best results, connect a heavy gauge wire or strap to a long ground rod. Make the distance between the [GND] terminal and ground as short as possible.

**⚠ WARNING! NEVER** connect the [GND] terminal to a gas or electric pipe, since the connection could cause an explosion or electric shock.

## ■ Antenna connection

### PL-259 CONNECTOR INSTALLATION EXAMPLE

- ① Slide the coupling ring onto the cable. Strip the cable jacket and tin the braid.
- ② Strip the cable as shown at left. Tin the center conductor.
- ③ Slide the connector body on and solder it.
- ④ Screw the coupling ring onto the connector body.

30 mm ≈ 1.18 in 10 mm ≈ 0.39 in 1-2 mm ≈ 0.04-0.08 in

For radio communications, the antenna is of critical importance, along with output power and receiver sensitivity. Select antenna(s), such as a well-matched 50 Ω antenna, and feedline. We recommend 1.5:1 or better of Voltage Standing Wave Ratio (VSWR) on your operating bands. The transmission line should be a coaxial cable.

When using a single antenna, use the [ANT1] connector.

**⚠ CAUTION:** Protect your transceiver from lightning by using a lightning arrester.

### Antenna SWR

Each antenna is tuned for a specified frequency range and SWR may be increased out-of-range. When the SWR is higher than approximately 2.0:1, the transceiver's power drops to protect the final transistors. In this case, an antenna tuner is useful to match the transceiver and antenna. Low SWR allows full power for transmitting. The IC-7700 has an SWR meter to monitor the antenna SWR continuously.

## ■ USB flash drive connection

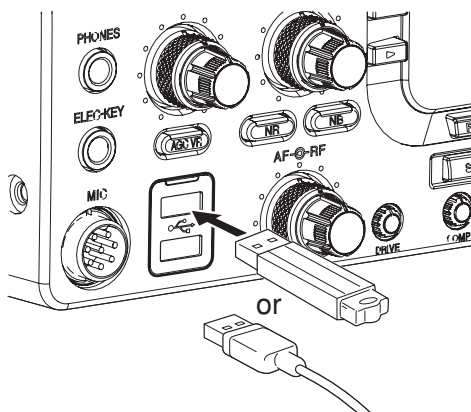

Connect the USB flash drive\* to the USB connector.

- Unmount operation is recommended before removing the USB flash drive\* (p.12-25).

**⚠** Make sure to connect the USB flash drive correctly. **NEVER** connect or remove the USB flash drive when the read/write indicator lights or blinks.

**⚠** A USB keyboard\* or USB hub\* can also be connected to the USB connector.

\*: USB flash drive, USB keyboard or USB hub is not supplied by Icom.

## Required connections

### Front panel

#### CW key

Connects an electronic keyer.

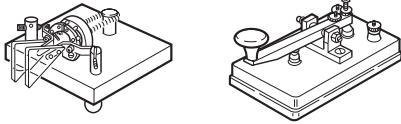

A straight or bug key can also be used when the keyer type is changed in keyer set mode. (p. 4-12)

#### Microphones (p. 2-10)

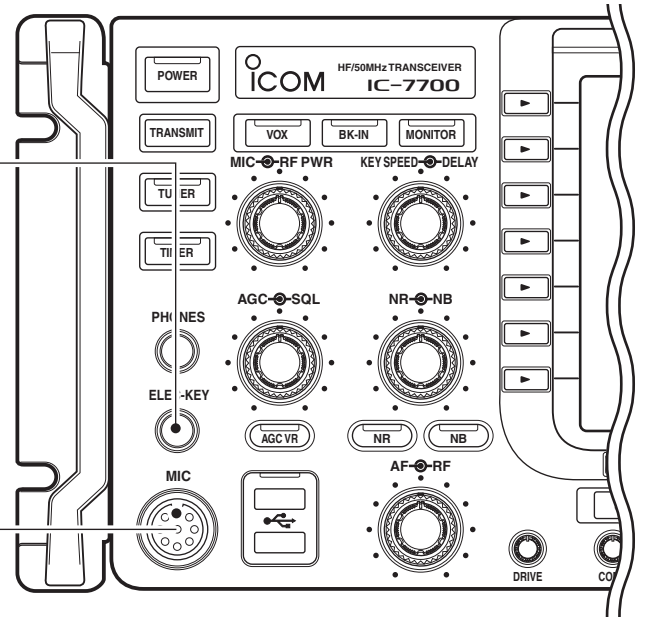

### Rear panel

#### Ground (p. 2-4)

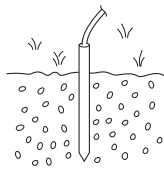

Use the heaviest gauge wire or strap available and make the connection as short as possible.

Grounding prevents electrical shocks, TVI and other problems.

#### AC outlet

**WARNING!**  
Use the supplied AC power cable only.

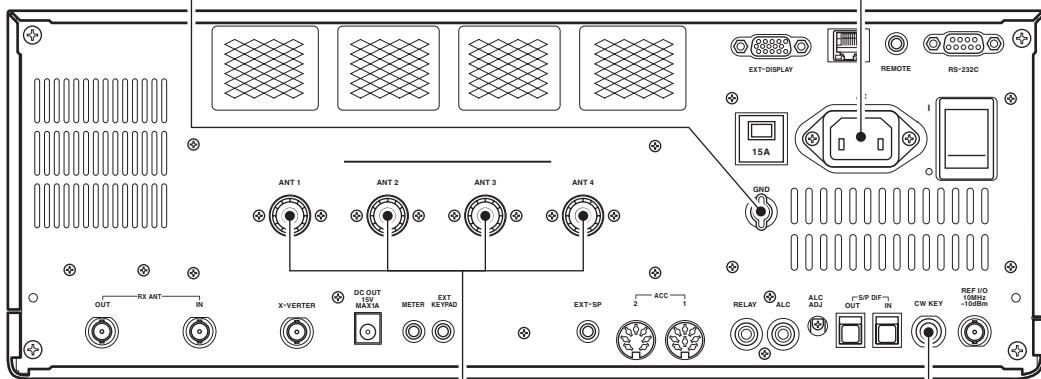

#### Antenna 1, 2, 3, 4 (p. 2-4)

[Example]: ANT1 for 1.8–18 MHz bands, ANT 2 for 21–28 MHz bands  
ANT3 for 50 MHz band, ANT 4 for receive antenna.

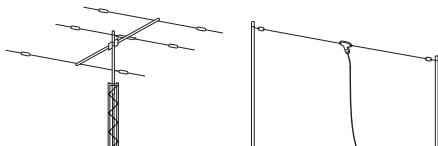

**NOTE:** Attach the supplied antenna connector cap when no antenna or external equipment is connected.

#### Straight key

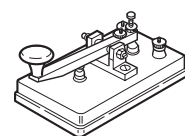

## Advanced connections

### Front panel

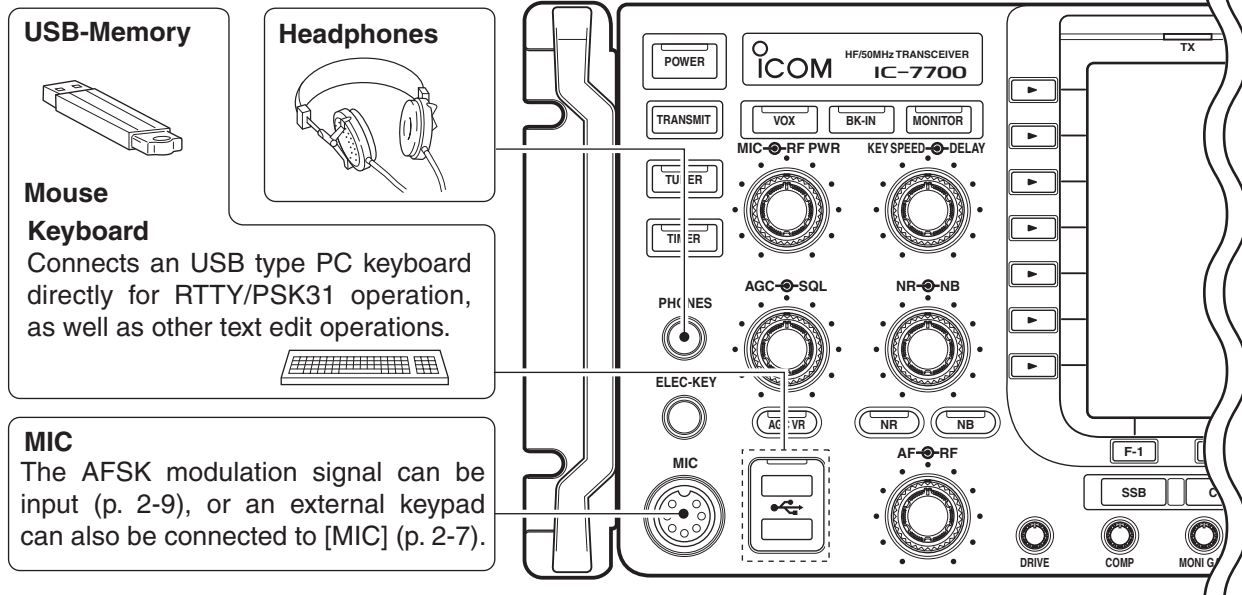

### Rear panel— 1

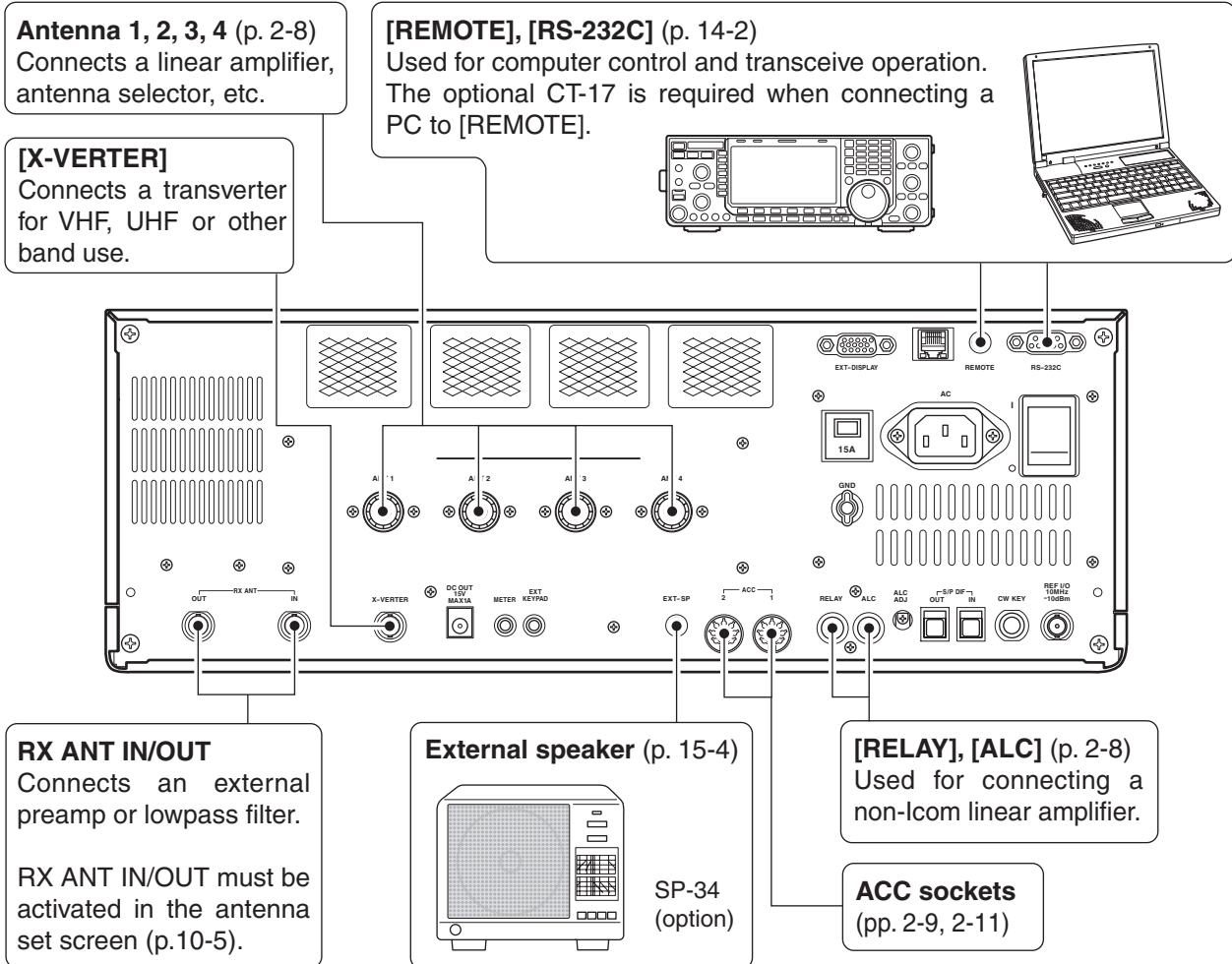



◇ Rear panel— 2

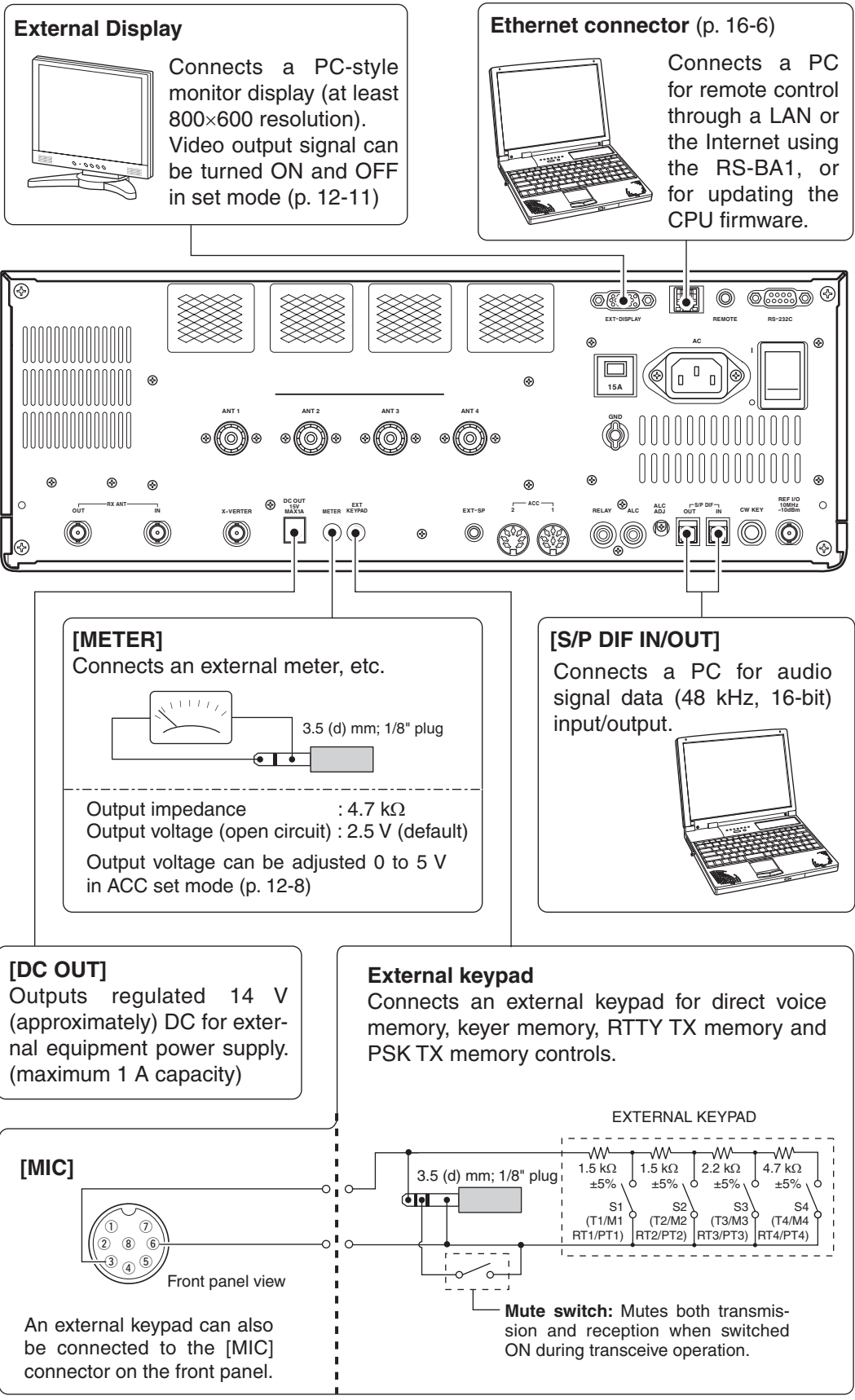

## Linear amplifier connections

### Connecting the IC-PW1/EURO

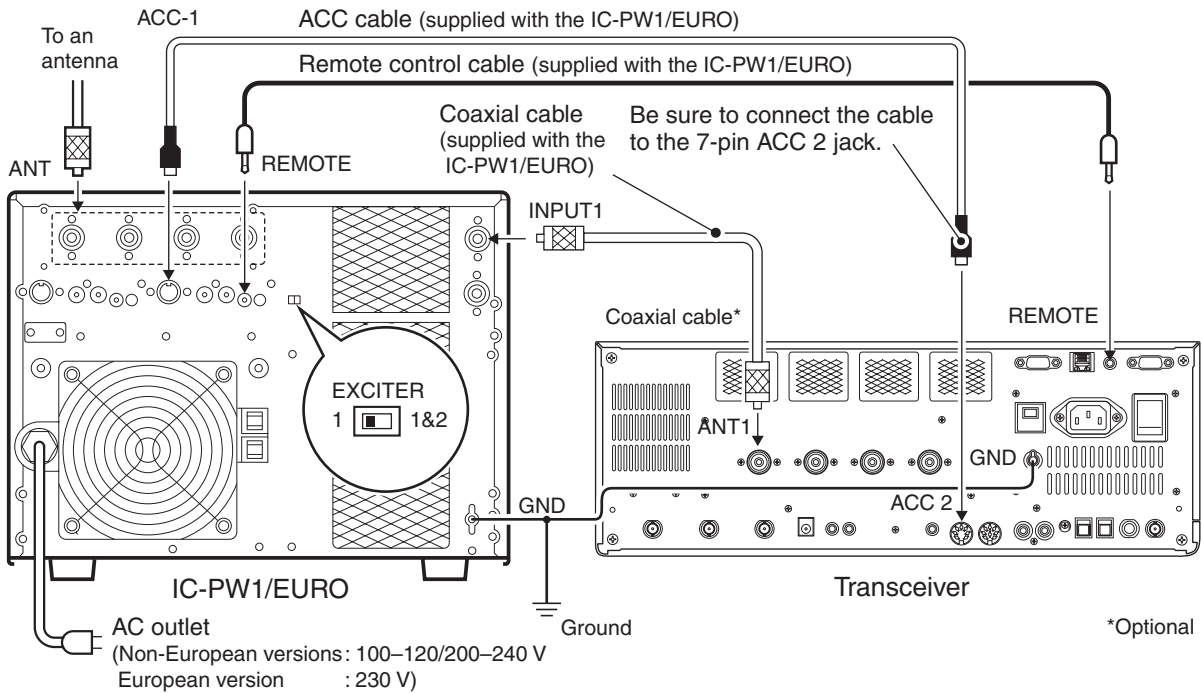

### Connecting a non-Icom linear amplifier

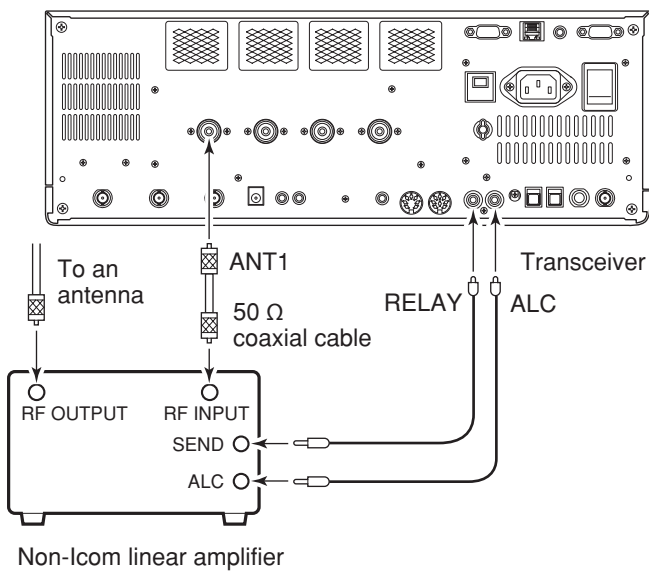

#### ⚠ WARNING!

Set the transceiver output power and linear amplifier ALC output level after referring to the linear amplifier instruction manual.

The ALC input level must be in the range 0 V to -4 V. The transceiver does not accept positive voltage. Non-matched ALC and RF power settings could overheat or damage the linear amplifier.

The maximum signal level of [RELAY] jack is 16 V/0.5 A DC with initial setting, and 250 V/200 mA with "MOSFET" setting (see page 12-8 for details). Use an external relay unit if your non-Icom linear amplifier requires control voltage and/or current greater than specified.

When using a linear amplifier that has a time delay between receiving and transmitting, a high SWR might cause the linear amplifier to malfunction. To prevent this, slow the TX Delay the "TX Delay (HF), (50M)" settings in the Others Set mode. (pp. 12-12, 12-13)

SET > OTHERS > TX Delay (HF), (50M)

## ■ Transverter jack information

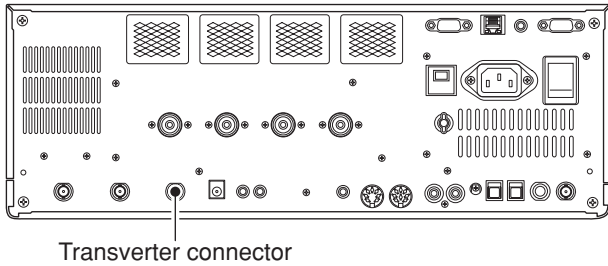

When 2 to 13.8 V is applied to pin 6 of [ACC 2], the [X-VERTER] connector is activated for transverter operation and the antenna connectors do not receive or transmit any signals.

While receiving, [X-VERTER] connector can be activated as an input terminal from an external transverter.

While transmitting, the [X-VERTER] connector outputs signals of the displayed frequency at  $-20$  dBm (22 mV) as signals for the external transverter.

## ■ FSK and AFSK connections

The transceiver has a Modem function for RTTY and PSK. However, if you want to use a PC to operate these digital modes, it is necessary to prepare the following interface circuit, or use a similar 3rd party device. Refer to the instruction manual for the device prior to connecting it.

### ◇ When using the ACC socket or the microphone connector

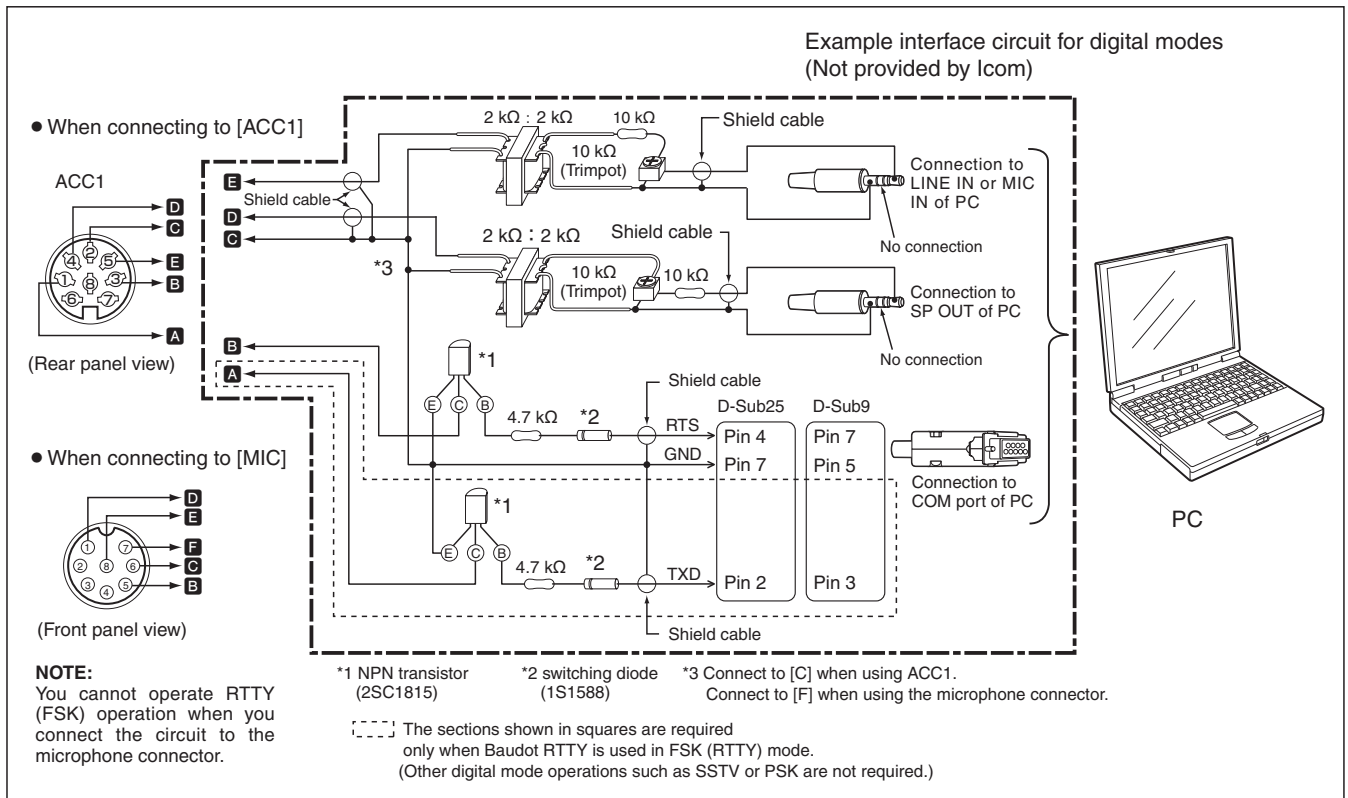

## Microphones (options)

### ◇ SM-50

TOP VIEW

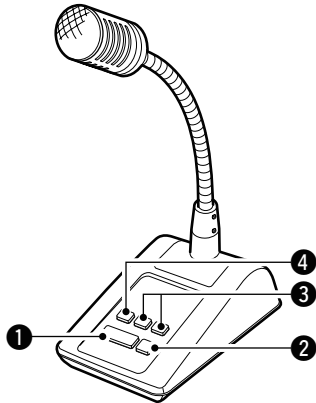

BOTTOM VIEW

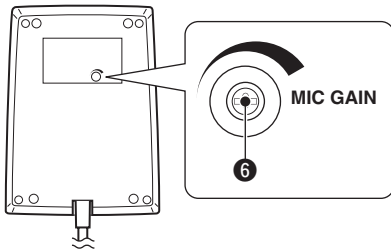

### ◇ SM-30

TOP VIEW

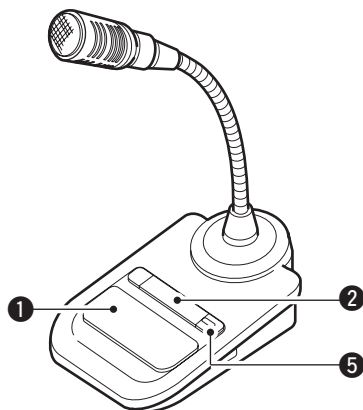

BOTTOM VIEW

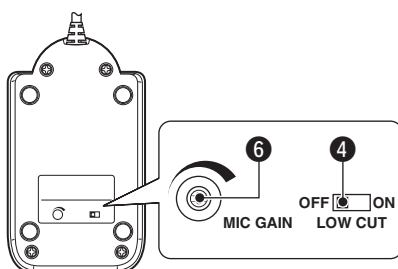

#### ① PTT SWITCH

Hold down to transmit, release to receive.

#### ② PTT LOCK SWITCH

Push to lock the PTT switch in the transmit mode.

#### ③ UP/DOWN SWITCHES [UP]/[DN]

Change the selected readout frequency or memory channel.

- Holding down continuously changes the frequency or memory channel number.
- While holding down [XFC], the transmit readout frequency can be controlled while in the split frequency mode.
- The [UP]/[DN] switch can simulate a key paddle. Preset in the keyer set mode. (p. 4-12)

#### ④ LOW CUT SWITCH

Push (SM-50)/Slide (SM-30) to cut out the low frequency components of input voice signals.

#### ⑤ PTT LOCK INDICATOR [LOCK]

(Only for the SM-30)

Lights red when the PTT lock switch (②) is ON.

#### ⑥ MIC GAIN VOLUME [MIC GAIN]

Rotate to adjust the microphone output level.

- Use this control as an addition to the microphone gain setting of the connected transceiver.

Rotating the control too far clockwise may result in an output level that is too high and transmit signal distortion.

◇ HM-36

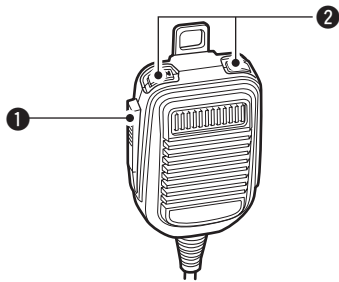

① PTT SWITCH

Hold down to transmit; release to receive.

② UP/DOWN SWITCHES [UP]/[DN]

Change the selected readout frequency or memory channel.

- Holding down continuously changes the frequency or memory channel number.
- While holding down [XFC], the transmit readout frequency can be controlled while in the split frequency mode.
- The [UP]/[DN] switch can simulate a key paddle. Preset in the keyer set mode. (p. 4-12)

■ Microphone connector information

(Front panel view)

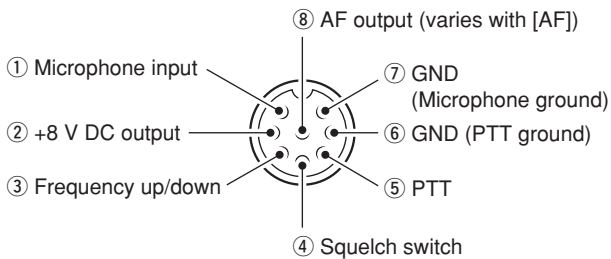

[MIC] Pin No.	FUNCTION	DESCRIPTION
②	+8 V DC output	Max. 10 mA
③	Frequency up	Ground
	Frequency down	Ground through 470 Ω
④	Squelch open	“Low” level
	Squelch closed	“High” level

**CAUTION:** DO NOT short pin 2 to ground as this can damage the internal 8 V regulator. DC voltage is applied to pin 1 for microphone operation. Use caution when using a non-Icom microphone.

## ■ Accessory connector information

ACC 1	PIN No.	NAME	DESCRIPTION	SPECIFICATIONS	
	1	RTTY	Controls RTTY keying	“High level” : More than 2.4 V “High level” : Less than 0.6 V Output current : Less than 2 mA	
	2	GND	Connects to ground. Connected in parallel with ACC 2 pin 2.	—	
	3	SEND*	Input/output pin. Connected in parallel with ACC 2 pin 3.	An external equipment controls the transceiver. When this pin goes low, the transceiver transmits. The transceiver outputs a low signal to control external equipment.	Input voltage (High) : 2.0 V to 20.0 V Input voltage (Low) : -0.5 V to 0.8 V Current flow : Max. 20 mA Output voltage (Low) : Less than 0.1 V Current flow : Max. 200 mA
	4	MOD	Modulator input. Connects to a modulator.	Input impedance : 10 kΩ Output level : Approximately 100 mV rms	
	5	AF	AF detector output. Fixed level, regardless of [AF] position in default settings. (see notes below)	Output impedance : 4.7 kΩ Output level : 100–300 mV rms	
	6	SQLS	Squelch output. Grounded when squelch opens.	SQL open : Less than 0.3 V/5 mA SQL closed : More than 6.0 V/100 μA	
	7	13.8 V	13.8 V output when power is ON. Connected in parallel with ACC 2 pin 7.	Output current : Maximum 1 A	
	8	ALC	ALC voltage input. Connected in parallel with ACC 2 pin 5.	Control voltage : -4 V to 0 V Input impedance : More than 10 kΩ	

**NOTE:** If the CW side tone level limit or beep level limit is in use, the CW side tone or beep tone decreases from the fixed level when the [AF] control is rotated above a specified level. (p. 12-6)

ACC 2	PIN No.	NAME	DESCRIPTION	SPECIFICATIONS
	1	8 V	Regulated 8 V output.	Output voltage : 8 V ±0.3 V Output current : Less than 10 mA
	2	GND	Same as ACC 1 pin 2.	
	3	SEND*	Same as ACC 1 pin 3.	
	4	BAND	Band voltage output. (Varies with amateur band)	Output voltage : 0 V to 8.0 V
	5	ALC	Same as ACC 1 pin 8.	
	6	TRV	Activates [X-VERTER] input/output when “HIGH” voltage is applied	Input impedance : More than 10 kΩ Input voltage : 2 V to 13.8 V
	7	13.8 V	Same as ACC 1 pin 7.	

\*When the SEND terminal controls the inductive load (such as a relay), a counter-electromotive force can cause the transceiver’s malfunction or damage. To prevent this, we recommend adding a switching diode, such as an “1SS133,” on the load side of the circuit to the counter-electromotive force absorption. When the diode is added, a switching delay of the relay may occur. Be sure to check its switching action before operation.

[Example]

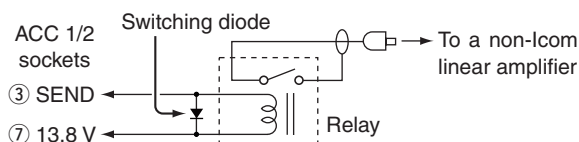

■ When first applying power (CPU resetting) .....	3-2
■ Initial settings .....	3-2
■ Selecting VFO/memory mode .....	3-3
■ VFO selection .....	3-3
◇ Selecting VFO-A/VFO-B .....	3-3
◇ VFO equalization .....	3-3
■ Selecting an operating band .....	3-4
◇ Using the band stacking registers .....	3-4
■ Frequency setting .....	3-5
◇ Tuning with the main dial .....	3-5
◇ Direct frequency entry with the keypad .....	3-5
◇ Quick tuning step .....	3-6
◇ Selecting “kHz” step .....	3-6
◇ 1/4 tuning step function .....	3-6
◇ Selecting 1 Hz step .....	3-7
◇ Auto tuning step function .....	3-7
■ Operating mode selection .....	3-8
■ Volume setting .....	3-9
■ RF gain adjustment .....	3-9
■ Squelch level adjustment .....	3-9
■ Meter indication selection .....	3-10
◇ Multi-function digital meter .....	3-10
◇ Meter type selection .....	3-11
■ Voice synthesizer operation .....	3-11
■ Basic transmit operation .....	3-12
◇ Transmitting .....	3-12
◇ Microphone gain adjustment .....	3-12
◇ Drive gain adjustment .....	3-13
■ Band edge warning beep .....	3-13
◇ Programming the user band edge .....	3-14

## ■ When first applying power (CPU resetting)

Before first applying power, make sure all connections required for your system are complete by referring to Section 2. Then, reset the transceiver using the following procedure.

Resetting **CLEARs** all programmed contents in memory channels and returns programmed values in set mode to default values.

- ① Turn the main power ON with [I/O] on the rear panel.
  - The transceiver power is still OFF and the power indicator lights orange.
- ② While holding down [F-INP ENT] and [MW], push [POWER] to turn power ON.
  - The CPU is reset.
  - The CPU start-up takes approximately 5 seconds.
  - The transceiver displays its initial VFO frequencies when resetting is complete.
- ③ Change the set mode settings after resetting, if desired.

In cooler temperatures, the LCD may appear dark and unstable after turning power ON. This is normal and does not indicate any equipment malfunction.

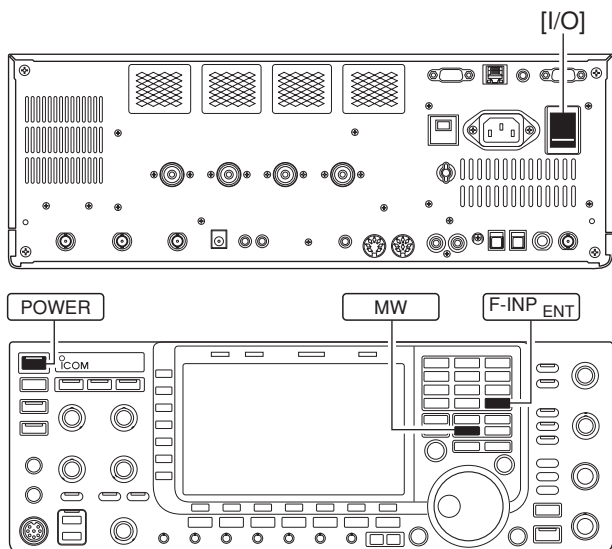

## ■ Initial settings

After resetting the transceiver, set controls as shown in the figure below.

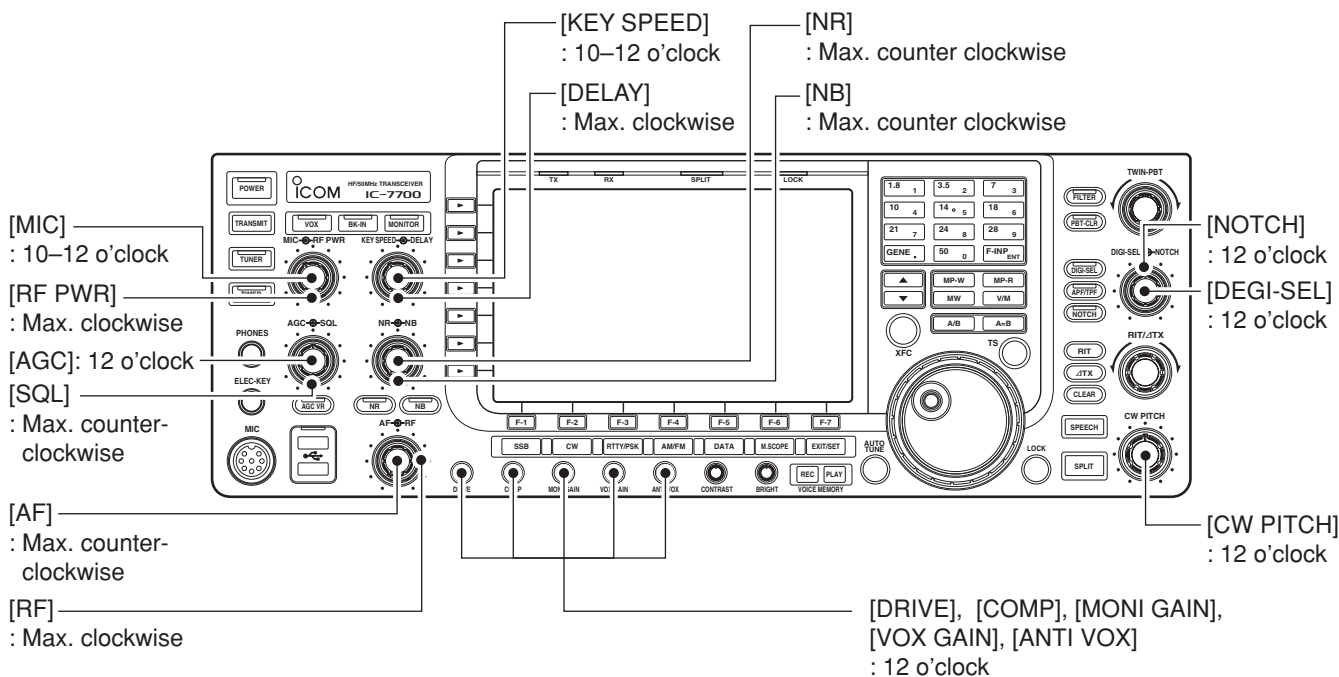



## ■ Selecting VFO/memory mode

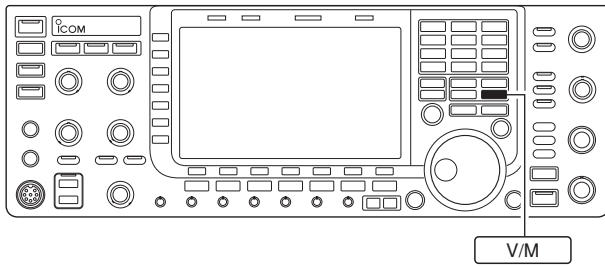

➔ Push **V/M** to switch between VFO and memory modes.

- **VFO-A** or **VFO-B** appears when in VFO mode, or the selected memory channel number appears when in memory mode.
- Holding down **V/M** for 1 second transfers the contents of the selected memory channel to VFO. (p. 8-4)



## ■ VFO selection

VFO is an abbreviation of Variable Frequency Oscillator, and is commonly referred to as a main tuning function.

The main dial is often called the "VFO knob."

### ◇ Selecting VFO-A/VFO-B

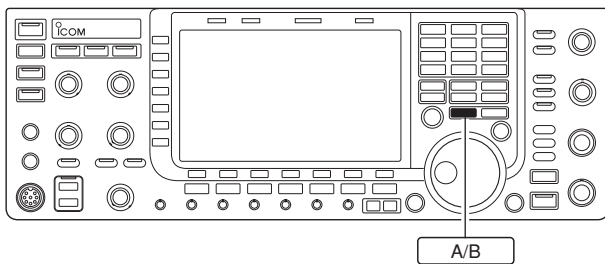

➔ In VFO mode, push **A/B** to toggle VFO-A and VFO-B.

- **VFO-A** or **VFO-B** appears when VFO-A or VFO-B is selected, respectively

### ◇ VFO equalization

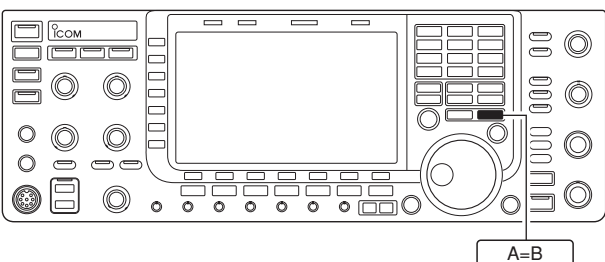

➔ In VFO mode, hold down **A=B** for 1 second to set the undisplayed VFO frequency and mode to those of the displayed VFO.

- Three beeps sound when the VFO equalization is completed.

## ■ Selecting an operating band

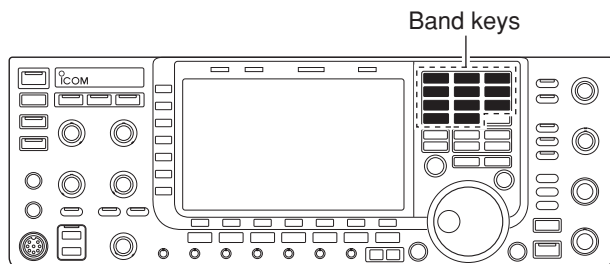

The triple band stacking register provides 3 memories for each band key, storing frequency and mode information.

This function is convenient when you operate 3 modes on one band. For example, one register is used for a CW frequency, another for an SSB frequency and the other one for an RTTY frequency.

If a band key is pushed once, the frequency and operating mode last used are called up. When the key is pushed again, another stored frequency and operating mode are called up.

See the table below for a list of the bands available and the default settings for each band.

BAND	REGISTER 1	REGISTER 2	REGISTER 3
1.8 MHz	1.900000 MHz CW	1.910000 MHz CW	1.915000 MHz CW
3.5 MHz	3.550000 MHz LSB	3.560000 MHz LSB	3.580000 MHz LSB
7 MHz	7.050000 MHz LSB	7.060000 MHz LSB	7.020000 MHz CW
10 MHz	10.120000 MHz CW	10.130000 MHz CW	10.140000 MHz CW
14 MHz	14.100000 MHz USB	14.200000 MHz USB	14.050000 MHz CW
18 MHz	18.100000 MHz USB	18.130000 MHz USB	18.150000 MHz USB
21 MHz	21.200000 MHz USB	21.300000 MHz USB	21.050000 MHz CW
24 MHz	24.950000 MHz USB	24.980000 MHz USB	24.900000 MHz CW
28 MHz	28.500000 MHz USB	29.500000 MHz USB	28.100000 MHz CW
50 MHz	50.100000 MHz USB	50.200000 MHz USB	51.000000 MHz FM
General	15.000000 MHz USB	15.100000 MHz USB	15.200000 MHz USB

### ◇ Using the band stacking registers

[Example]: 14 MHz band

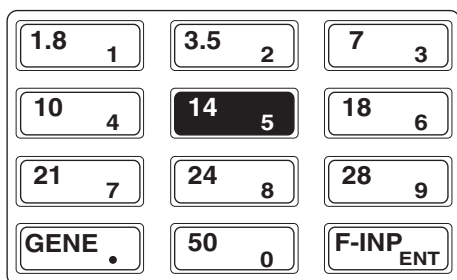

- ① Push **[14 5]**, then select a frequency and an operating mode.
  - The previously selected frequency and an operating mode are memorized in first band stacking register of that band.
- ② Push **[14 5]** again, then select another frequency and operating mode.
  - The frequency and operating mode that is selected in step ① are memorized in 14 MHz first band stacking register.
- ③ Push **[14 5]** again, then select another frequency and operating mode.
  - The frequency and operating mode that is selected in step ② are memorized in 14 MHz second band stacking register.
- ④ Push **[14 5]** again, then select another frequency and operating mode.
  - The frequency and operating mode that is selected in step ③ are memorized in 14 MHz third band stacking register.
  - When **[14 5]** is pushed again, the first band stacking register set in step ②, is over written.

## Frequency setting

The transceiver has several tuning methods for convenient frequency tuning.

### ◇ Tuning with the main dial

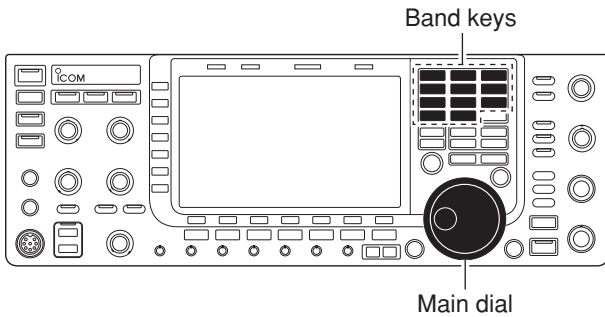

- ① Push the desired band key on the keypad 1–3 times.
  - Three different frequencies can be selected on each band with the band key.
- ② Rotate the main dial to set the desired frequency.

▨ If the dial lock function is activated, the lock indicator lights, and the main dial does not function. In this case, push [LOCK] to deactivate the lock function. (See page 5-18 for details.)

### ◇ Direct frequency entry with the keypad

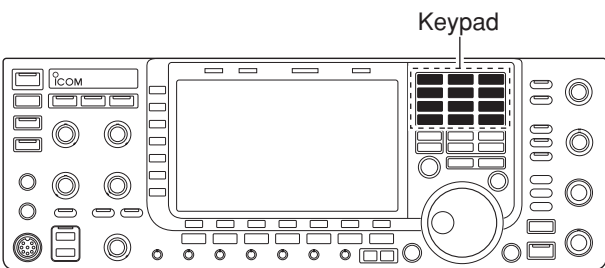

The transceiver has a keypad for direct frequency entry as described below.

- ① Push [F-INP ENT].
  - “F-INP” indicator appears.
- ② Input the desired frequency.
  - Push [GENE .] to input “. (decimal point)” between the MHz units and kHz units.
- ③ Push [F-INP ENT] to set the input frequency.
  - To cancel the input, push any other key (except ▲ or ▼) instead of [F-INP ENT].

#### [EXAMPLE]

7.0000 MHz

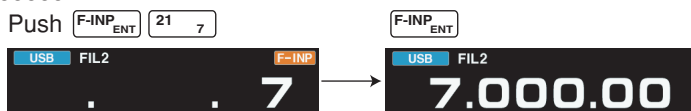

21.2400 MHz

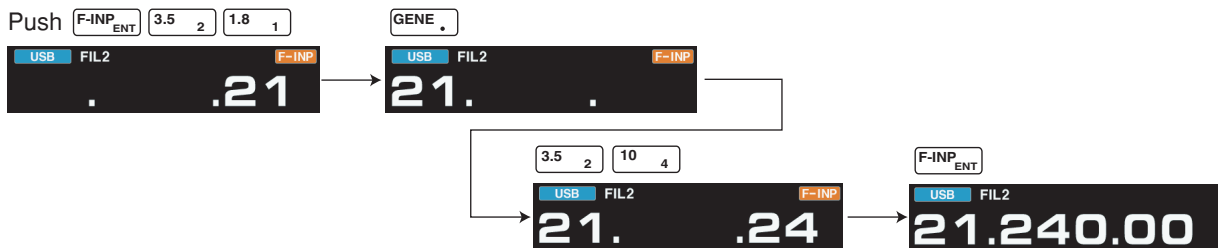

21.2400 MHz ⇒ 21.3600 MHz



850 kHz (0.85000 MHz)



### 3 BASIC OPERATIONS

#### ◇ Quick tuning step

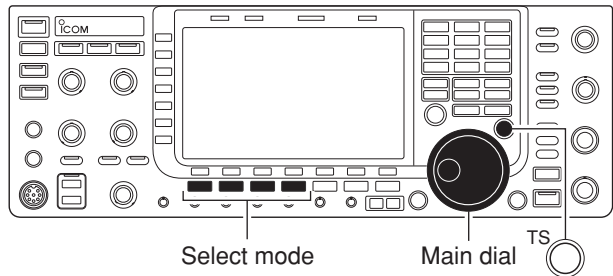

Quick tuning indicator

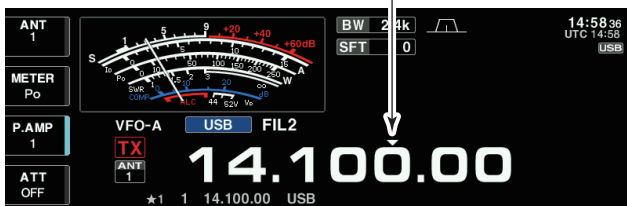

The operating frequency can be changed in larger steps (0.1, 1, 5, 9, 10, 12.5, 20 or 25 kHz selectable) for quick tuning.

- ① Push [TS] to turn the quick tuning function ON.
  - “▼” appears when the quick tuning function is ON.
- ② Rotate the main dial to change the frequency in programmed kHz steps.
- ③ Push [TS] again to turn OFF the indicator.
- ④ Rotate the main dial for normal tuning if desired.

#### ◇ Selecting “kHz” step



- ① Push [TS] to turn the quick tuning function ON or OFF.
  - “▼” appears when the quick tuning function ON.
- ② Hold down [TS] for 1 second to enter quick tuning step set mode.
  - Selected tuning steps for all modes appear.
- ③ Select the desired operating mode.
- ④ Rotate the main dial to select the desired tuning step.
- ⑤ Repeat steps ③ and ④ to select quick tuning steps for other modes, if desired.
- ⑥ Push [EXIT/SET] to exit the setting display.

**NOTE:** When entering quick tuning step set mode, the quick tuning function must be activated first.

#### ◇ 1/4 tuning step function

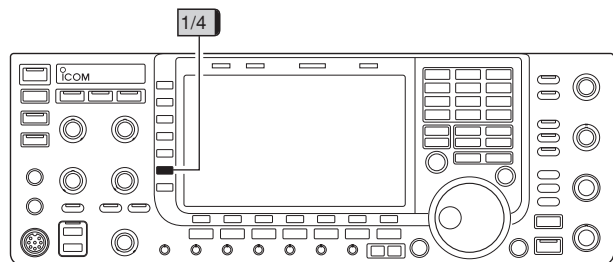

1/4 tuning step OFF      1/4 tuning step ON



When operating in SSB data, CW, RTTY or PSK, the 1/4 tuning function is selectable. Dial rotation is reduced to 1/4 of normal speed when the 1/4 tuning function is ON for finer tuning control.

- Push [1/4] (MF6) to toggle the 1/4 tuning function ON or OFF.
  - “1/4” appears when the 1/4 tuning function is ON.

◇ Selecting 1 Hz step

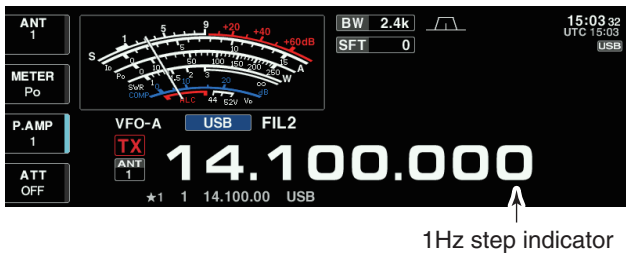

A minimum tuning step of 1 Hz can be used for fine tuning.

- ① Push [TS] to turn the quick tuning function OFF.
- ② Hold down [TS] for 1 second to turn the 1 Hz tuning step ON or OFF.

◇ Auto tuning step function

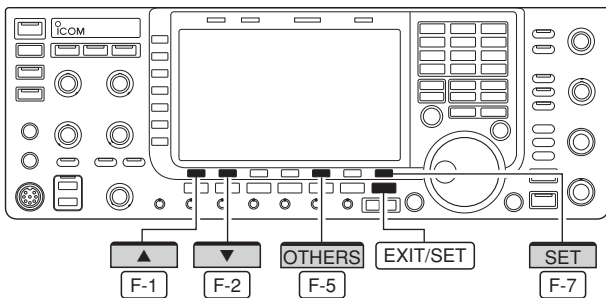

When rotating the main dial rapidly, the tuning speed accelerates automatically as selected.

- ① Push [EXIT/SET] several times to close a multi-function screen, if necessary.
- ② Push [SET] [F-7] to select set mode menu screen.
  - Holding down [EXIT/SET] for 1 second also selects set mode menu screen.
- ③ Push [OTHERS] [F-5] to enter Others set mode.
- ④ Push [▲] [F-1] or [▼] [F-2] to select “MAIN DIAL Auto TS.”
- ⑤ Rotate the main dial to select the desired condition from HIGH, LOW and OFF.
  - HIGH: Approximately 5 times faster when the tuning step is set to 1 kHz or smaller steps; approximately 2 times faster when the tuning step is set to 5 kHz or larger steps.
  - LOW : Approximately 2 times faster
  - OFF : Auto tuning step is turned OFF.
- ⑥ Push [EXIT/SET] to exit the set mode.

## ■ Operating mode selection

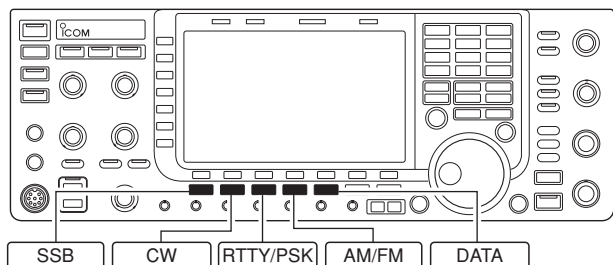

SSB (USB/LSB), SSB data (USB data/LSB data), CW, CW reverse (CW-R), RTTY, RTTY reverse (RTTY-R), PSK, PSK reverse (PSK-R), AM, AM data, FM and FM data modes are selectable in the IC-7700. Select the desired operation mode as follows.

To select a mode of operation, push the desired mode switch momentarily. Push the switch again to toggle between USB and LSB, CW and CW-R, RTTY/RTTY-R and PSK/PSK-R, AM and FM, if desired. Hold down the switch for 1 second to toggle between RTTY and RTTY-R, PSK and PSK-R, if desired.

See the diagram below left for the order of selection.

Microphone signals are muted when data mode is selected.

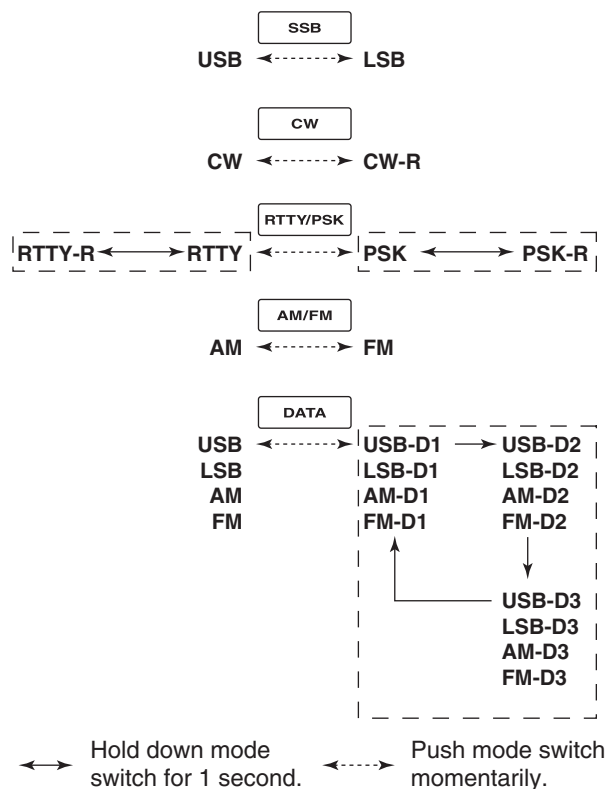

### • Selecting SSB mode

- ➔ Push **SSB** to select USB or LSB.
  - USB is selected first when above 10 MHz; or LSB is selected first when below 10 MHz operation. (USB is selected when 5 MHz band is selected for the USA version.)
  - After USB or LSB is selected, push **SSB** to toggle between USB and LSB.

### • Selecting CW mode

- ➔ Push **CW** to select CW.
  - After CW is selected, push **CW** to toggle between CW and CW reverse mode.

### • Selecting RTTY/PSK mode

- ➔ Push **RTTY/PSK** to select RTTY or PSK.
  - After RTTY or PSK is selected, push **RTTY/PSK** to toggle between RTTY and PSK.
  - After RTTY or PSK is selected, hold down **RTTY/PSK** for 1 second to toggle between RTTY and RTTY reverse, or, PSK and PSK reverse mode, respectively.

### • Selecting AM/FM mode

- ➔ Push **AM/FM** to select AM or FM.
  - After AM or FM is selected, push **AM/FM** to toggle between AM and FM.

### • Selecting DATA mode

- ➔ After USB, LSB, AM or FM is selected, push **DATA** to select USB data, LSB data, AM data or FM data mode, respectively.
  - After data mode is selected, push **DATA** to toggle between regular voice and data mode.
  - After data mode is selected, hold down **DATA** for 1 second to select data 1, 2 and 3 in sequence.

## ■ Volume setting

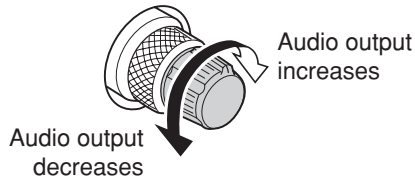
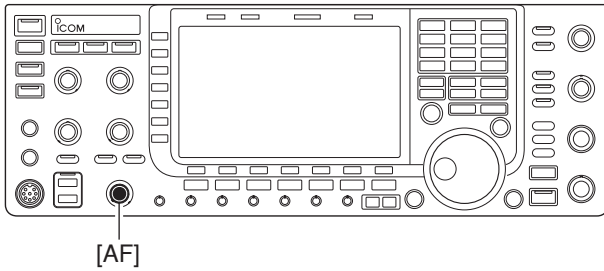

➔ Rotate [AF] control clockwise to increase, counterclockwise to decrease the audio output level.

## ■ RF gain adjustment

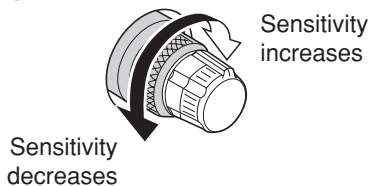
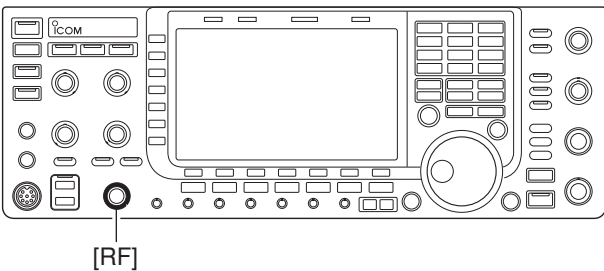

➔ Rotate [RF] control clockwise to increase, counterclockwise to decrease the receiver sensitivity.

**NOTE:**  
When [RF] control is adjusted CCW in FM mode, audio output decreases then disappears. This is normal, not a malfunction.

## ■ Squelch level adjustment

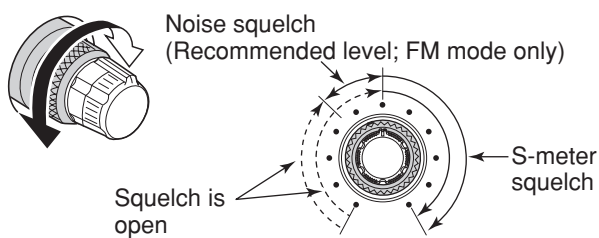
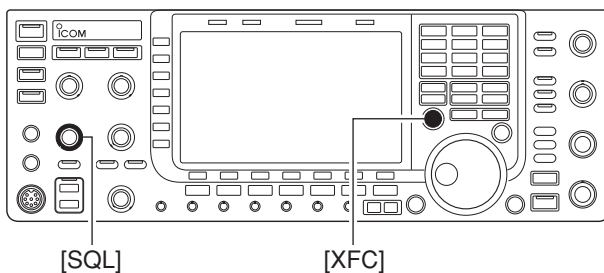

The squelch mutes noise output from the speaker (closed squelch) when no signal is received.

➔ When no signal is received, rotate [SQL] control fully counterclockwise first, then rotate [SQL] clockwise to the point at which the noise disappears.  
• Hold down [XFC] to open the squelch temporarily.

## Meter indication selection

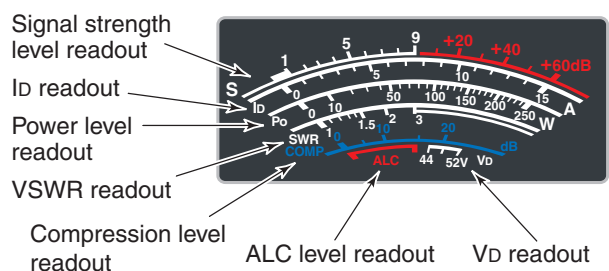
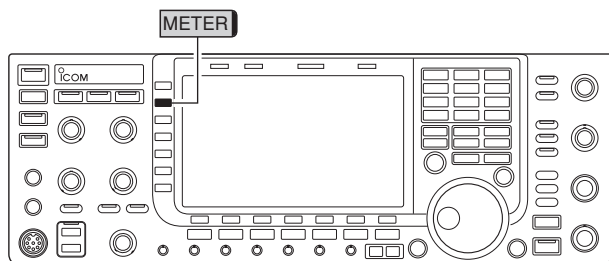

The S/RF meter indication, during transmit, can be selected from the following items as you desire.

➔ Push [METER] (MF2) several times to select the desired item.

- METER Po** Indicates the RF output power in watts.
- METER SWR** Indicates the VSWR on the transmission line.
- METER ALC** Indicates the ALC level. The ALC circuit begins to activate when the RF output power reaches a preset level.
- METER COMP** Indicates the compression level when the speech compressor is in use.
- METER Id** Indicates the drain current of the final amplifier MOSFETs.
- METER Vd** Indicates the drain terminal voltage of the final amplifier MOSFETs.

## Multi-function digital meter

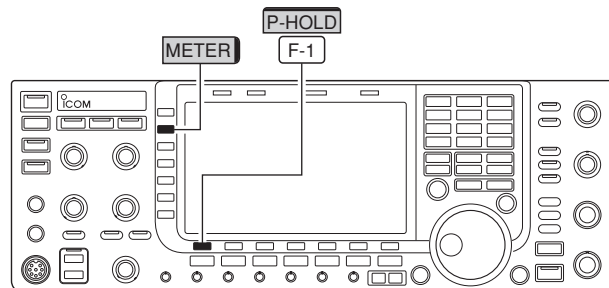

The IC-7700 can display the multi-function digital meter on the LCD display. This meter displays all transmit parameters simultaneously.

- ① Hold down [METER] for 1 second to turn the multi-function digital meter ON.
- ② Push [P-HOLD] [F-1] to toggle the peak level hold function ON.
  - “P-HOLD” appears on the window title when the peak level hold function is ON.
- ③ Hold down [METER] for 1 second, or push [EXIT/SET] to turn the multi-function digital meter OFF.

“P-HOLD” indicator

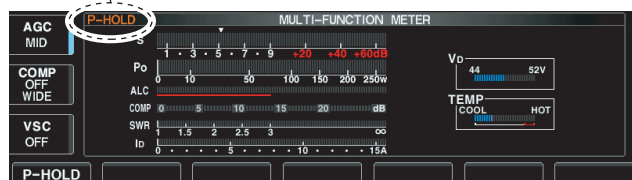



### ◇ Meter type selection

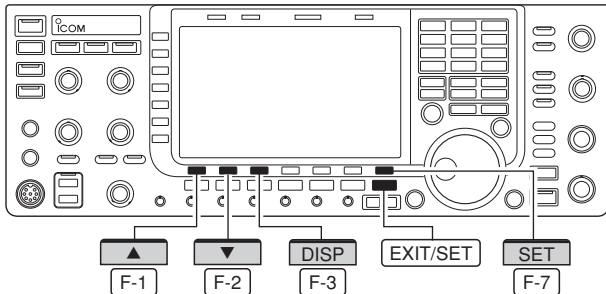

A total of 3 meter types are available in the IC-7700—Standard, Edgewise and Bar meters. Follow the instructions below for the meter type selection.

- ① Push [EXIT/SET] several times to return to normal screen, if necessary.
- ② Push [SET] [F-7], then push [DISP] [F-3] to select display set mode.
- ③ Push [▲] [F-1] or [▼] [F-2] to select “Meter type (Normal Screen)” item.
- ④ Rotate the main dial to select the desired meter type from “Standard,” “Edgewise” and “Bar.”
- ⑤ Push [EXIT/SET] to exit display set mode.



#### • Edgewise meter

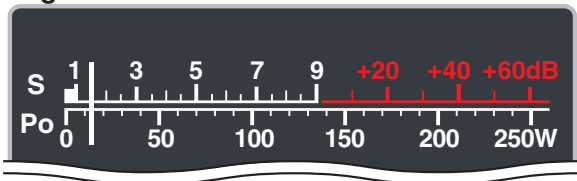

#### • Bar meter



## ■ Voice synthesizer operation

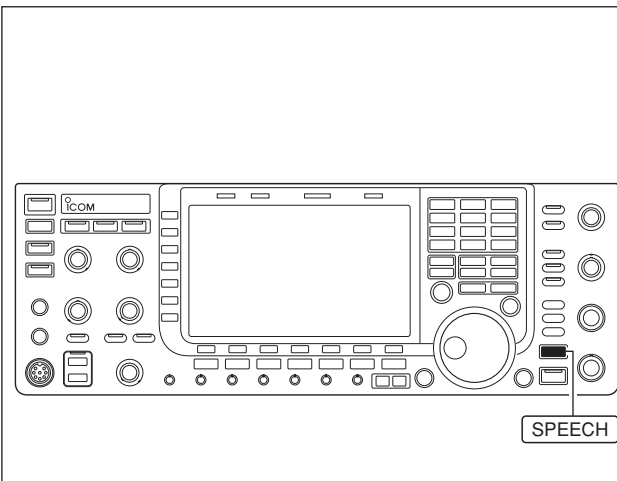

The IC-7700 has a built-in voice synthesizer to announce the frequency, mode, etc. (S-meter level can also be announced—p. 12-15) in clear, electronically-generated voice, in English (or Japanese).

- Push [SPEECH] to announce the currently selected frequency, etc.
  - Hold down [SPEECH] for 1 second to additionally announce the selected mode.
- Pushing a mode switch also announces the appropriate mode. (p. 12-15)

▨ The output level of the voice synthesizer can be adjusted in level set mode. (p. 12-6)

## Basic transmit operation

Before transmitting, monitor your selected operating frequency to make sure transmitting won't cause interference to other stations on the same frequency. It's good amateur practice to listen first, and then, even if nothing is heard, ask "is the frequency in use" once or twice, before you begin operating on that frequency.

### Transmitting

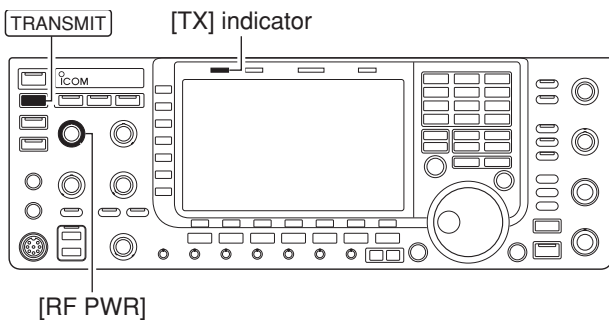

Before transmitting, monitor your selected operating frequency to make sure transmitting won't cause interference to other stations on the same frequency.

- ① Push **TRANSMIT** or **[PTT]** (microphone) to transmit.
  - The **[TX]** indicator lights red.
- ② Push **TRANSMIT** again or release **[PTT]** (microphone) to return to receive.

#### Adjusting the transmit output power

- ➔ Rotate **[RF PWR]**.
  - Adjustable range : 5 W to 200 W  
(AM mode: 5 W to 50 W)

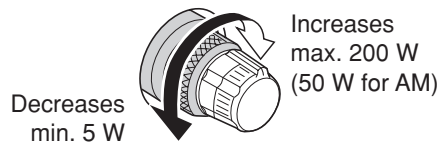

### Microphone gain adjustment

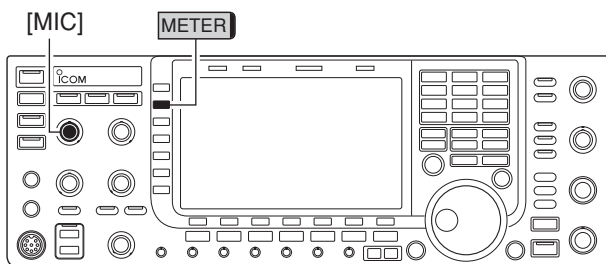

Before transmitting, monitor your selected operating frequency to make sure transmitting won't cause interference to other stations on the same frequency.

- ① Push **[METER]** (MF2) to select the ALC meter.
- ② Push **[PTT]** (microphone) to transmit.
  - Talk into the microphone at your normal voice level.
- ③ While talking into the microphone, rotate **[MIC]** so that the ALC meter reading doesn't go outside the ALC zone. (see at left)
- ④ Release **[PTT]** (microphone) to return to receive.

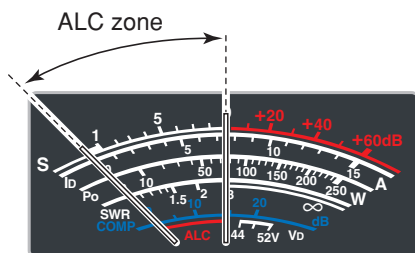

◇ Drive gain adjustment

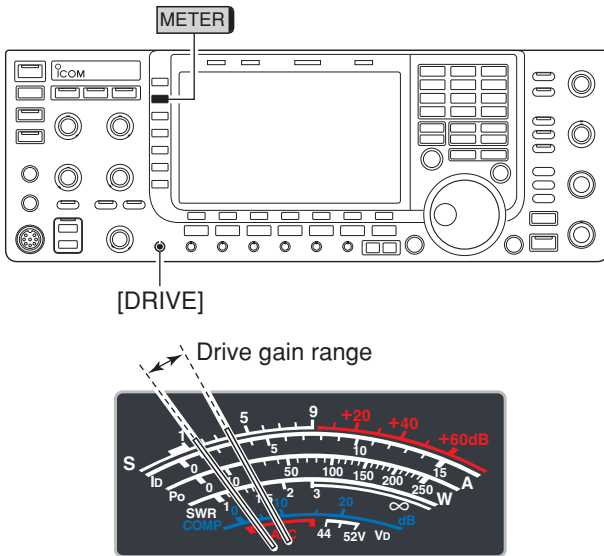

The drive gain is active for all modes other than SSB mode with speech compressor OFF. The [DRIVE] control adjusts the gain of the driver stage.

Before transmitting, monitor your selected operating frequency to make sure transmitting won't cause interference to other stations on the same frequency.

- ① Push [METER] (MF2) to select the ALC meter.
- ② Push [PTT] (microphone; SSB with [COMP] ON, AM or FM), key down (CW) or push [TRANSMIT] (RTTY or PSK) to transmit.
- ③ While talking into the microphone, keying down or transmitting, rotate [DRIVE] so that the ALC meter reading is between 30 to 50% of the ALC scale. (see left)
  - Talk into the microphone at your normal voice level.
- ④ Release [PTT], stop keying or push [TRANSMIT] again to return to receive.

■ Band edge warning beep

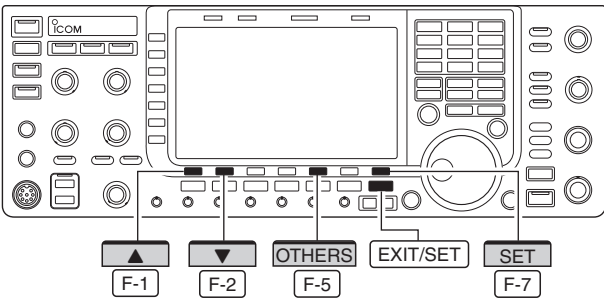

This function allows you to hear a beep tone when you tune in or out of an amateur band's frequency range. A regular beep sounds when you tune into a range, and a lower tone error beep will sound when you tune out of a range. Also, the TX indicator shows if the selected frequency is in or out of an amateur band, when an option other than "OFF" is set.

- A TX indicator with dotted rectangle, "TX" is displayed, instead of the regular "TX" TX indicator, when a frequency outside of an amateur band frequency range is selected.



• Band edge warning beep settings

OFF : Band edge beep is OFF.  
 ON (Default) : When you tune into or out of the default amateur band's frequency range, a beep sounds. (default)  
 ON (User) : When you tune outside of, or back into a user programmed amateur band's frequency range, a beep sounds.  
 ON (User) & TX Limit :  
 When you tune outside of, or back into a user programmed amateur band's frequency range, a beep sounds. Transmission is also inhibited outside the programmed range.

- ① Push [EXIT/SET] several times to close a multi-function screen, if necessary.
- ② Push [SET] [F-7] to select set mode menu screen.
  - Holding down [EXIT/SET] for 1 second also selects set mode menu screen.
- ③ Push [OTHERS] [F-5] to enter Others set mode.
- ④ Push [▲] [F-1] or [▼] [F-2] to select "Beep (Band Edge)."
- ⑤ Rotate the main dial to select the desired band edge warning beep setting. (see at left)
- ⑥ Push [EXIT/SET] to exit the set mode.

▨ The beep output level can be set in level set mode. (p. 12-6).

When the transverter function is in use, the band edge warning beep sounds with the default setting.

### 3 BASIC OPERATIONS

#### ◇ Programming the user band edge



Appears when “ON (User)” or “ON (User) & TX Limit” is selected.

#### • Band edge screen



- ① Select the Others set mode and select the “Beep (Band Edge)” option.
- ② Rotate the main dial to select either the “ON (User)” or “ON (User) & TX Limit” setting.
  - [BAND] appears above [F-5].
- ③ Push [BAND] [F-5] to open the band edge screen.
- ④ Push [▲] [F-1] or [▼] [F-2] to select the desired band edge.
  - Push [◀ ▶] [F-3] to select the upper and lower band edge frequency entry cell.
  - Push [INS] (MF6) to insert a new blank band edge line.
  - Hold down [DEL] (MF7) for 1 second to delete the selected band edge line.
- ⑤ Push [F-INP ENT], and then input the desired frequency with the keypad.
  - Push [GENE.] to input decimal point (“.”) between the MHz and kHz digits.
  - Program each channel from left to right and each frequency must be higher than the preceding frequency.
  - The frequency that is duplicated, or out of an amateur band, cannot be programmed.
  - If you want to return the band edge frequencies to their default (initial) value, hold down [DEF] [F-4] for 1 second.

The band edge initialize screen appears as shown below, then hold down [OK] [F-6] for 1 second to initialize all band edge frequency settings.

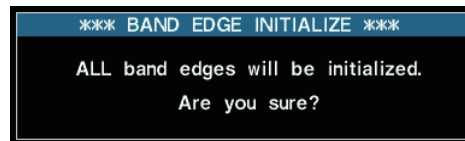

- ⑥ Push [F-INP ENT] to set the input frequency.
- ⑦ Push [EXIT/SET] to exit the set mode.

■ Operating SSB .....	4-2
◇ Convenient functions for receive .....	4-2
◇ Convenient functions for transmit .....	4-3
◇ About 5 MHz band operation (USA version only) .....	4-3
■ Operating CW .....	4-4
◇ Convenient functions for receive .....	4-4
◇ Convenient functions for transmit .....	4-5
◇ About CW reverse mode .....	4-5
◇ About CW pitch control .....	4-5
◇ CW side tone function .....	4-5
◇ APF (Audio Peak Filter) operation .....	4-6
■ Electronic keyer functions .....	4-7
◇ Memory keyer screen .....	4-8
◇ Editing a memory keyer .....	4-9
◇ Contest number set mode .....	4-10
◇ Keyer set mode .....	4-11
■ Operating RTTY (FSK) .....	4-13
◇ Convenient functions for receive .....	4-14
◇ About RTTY reverse mode .....	4-14
◇ Twin peak filter .....	4-14
◇ Functions for the RTTY decoder display .....	4-15
◇ Setting the decoder threshold level .....	4-15
◇ RTTY memory transmission .....	4-16
◇ Automatic transmission/reception setting .....	4-16
◇ Editing RTTY memory .....	4-17
◇ RTTY decode set mode .....	4-18
◇ Data saving .....	4-20
■ Operating PSK .....	4-21
◇ Convenient functions for receive .....	4-22
◇ About BPSK and QPSK modes .....	4-22
◇ Functions for the PSK decoder display .....	4-23
◇ Setting the decoder threshold level .....	4-23
◇ PSK memory transmission .....	4-24
◇ Automatic transmission/reception setting .....	4-24
◇ Editing PSK memory .....	4-25
◇ PSK decode set mode .....	4-26
◇ Data saving .....	4-28
■ Operating AM .....	4-29
◇ Convenient functions for receive .....	4-29
◇ Convenient functions for transmit .....	4-30
■ Operating FM .....	4-31
◇ Convenient functions for receive .....	4-31
◇ Convenient functions for transmit .....	4-31
■ Repeater operation .....	4-32
◇ Repeater access tone frequency setting .....	4-33
■ Tone squelch operation .....	4-34
■ Data mode (AFSK) operation .....	4-35

## Operating SSB

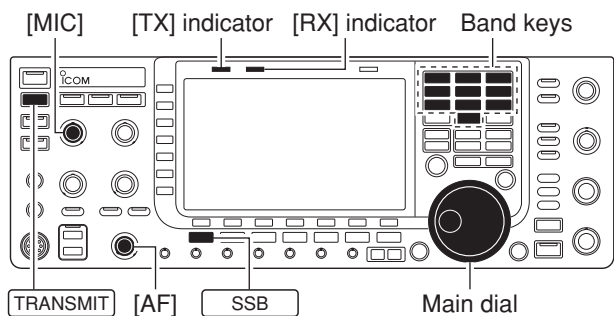

- ① Push a band key to select the desired band.
- ② Push **SSB** to select LSB or USB.
  - “USB” or “LSB” appears.
  - Below 10 MHz LSB is automatically selected; above 10 MHz USB is automatically selected.
- ③ Rotate the main dial to tune a desired signal.
  - The S-meter indicates received signal strength when a signal is received.
- ④ Rotate [AF] to set audio to a comfortable listening level.
- ⑤ Push **TRANSMIT** or [PTT] (microphone) to transmit.
  - [TX] indicator lights red.
- ⑥ Speak into the microphone at your normal voice level.
  - Adjust the microphone gain with [MIC] at this step, if necessary.
- ⑦ Push **TRANSMIT** or release [PTT] (microphone) to return to receive.

## Convenient functions for receive

- **Preamp** (p. 5-10)
  - ➔ Push [P.AMP] (MF3) several times to set the preamp OFF, preamp 1 ON or preamp 2 ON.
    - Hold down [P.AMP] (MF3) for 1 second to turn the preamp function OFF.
    - “P.AMP1” or “P.AMP2” appears when the preamp 1 or preamp 2 is ON, respectively.
- **Attenuator** (p. 5-10)
  - ➔ Push [ATT] (MF4) several times to set the attenuator in 6 dB steps.
    - Hold down [ATT] (MF4) for 1 second to turn the attenuator function OFF.
    - “ATT” and attenuation level appear when the attenuator is ON.
- **Noise blanker** (p. 5-17)
  - ➔ Push **NB** to turn the noise blanker ON or OFF, and then rotate [NB] control to adjust the threshold level.
    - Noise blanker indicator (above **NB** switch) lights when the noise blanker is ON.
    - Hold down **NB** for 1 second to enter noise blanker set mode.
- **Twin PBT (passband tuning)** (p. 5-13)
  - ➔ Rotate [TWIN PBT] controls (inner/outer).
    - PBT indicator (above **PBT-CLR** switch) lights when PBT is in use.
    - Hold down **PBT-CLR** for 1 second to clear the settings.
- **Audio tone control** (p. 12-4)
  - ➔ Push [SET] **F-7** then [LEVEL] **F-1** to enter level set mode. Select an item with **▲** **F-1** / **▼** **F-2** then rotate the main dial to adjust the audio tone.
- **Noise reduction** (p. 5-18)
  - ➔ Push **NR** to turn the noise reduction ON or OFF.
    - Rotate [NR] control to adjust the noise reduction level.
    - Noise reduction indicator (above **NR** switch) lights when the noise reduction is ON.
- **Notch filter** (p. 5-19)
  - ➔ Push **NOTCH** to turn the auto or manual notch function ON or OFF.
    - Rotate [NOTCH] control to set the “valley” frequency for manual notch operation.
    - Notch indicator (above **NOTCH** switch) lights when either the auto or manual notch is ON.
- **AGC (auto gain control)** (p. 5-12)
  - ➔ Push [AGC] (MF5) switch several times to select AGC FAST, AGC MID or AGC SLOW.
  - ➔ Push **AGC VR** to turn the AGC time constant manual setting ON or OFF.
    - Rotate [AGC] control to adjust the time constant.
- **VSC (voice squelch control)** (p. 9-3)
  - ➔ Push [VSC] (MF7) to turn the VSC function ON or OFF.
    - The VSC indicator appears when the voice squelch function is set to ON.

### ◇ Convenient functions for transmit

- |  |   |
|--|---|
| <ul style="list-style-type: none"> <li>• <b>Speech compressor</b> (p. 6-5)           <ul style="list-style-type: none"> <li>➔ Push [COMP] (MF6) to turn the speech compressor ON or OFF.               <ul style="list-style-type: none"> <li>• Hold down [COMP] (MF6) for 1 second to select the compression bandwidth from wide, middle and narrow.</li> </ul> </li> </ul> </li> <li>• <b>VOX (voice operated transmit)</b> (p. 6-2)           <ul style="list-style-type: none"> <li>➔ Push [VOX] to turn the VOX function ON or OFF.               <ul style="list-style-type: none"> <li>• “<b>VOX</b>” appears when the VOX function is ON.</li> </ul> </li> </ul> </li> </ul> | <ul style="list-style-type: none"> <li>• <b>Transmit quality monitor</b> (p. 6-4)           <ul style="list-style-type: none"> <li>➔ Push [MONITOR] to turn the monitor function ON or OFF.               <ul style="list-style-type: none"> <li>• Rotate [MONI GAIN] to adjust the monitor gain.</li> <li>• Monitor indicator (above [MONITOR] switch) lights when the monitor function is ON.</li> </ul> </li> </ul> </li> <li>• <b>Audio tone control</b> (p. 12-5)           <ul style="list-style-type: none"> <li>➔ Push [SET] [F-7] then [LEVEL] [F-1] to enter level set mode. Select an item with [▲] [F-1]/[▼] [F-2] then rotate the main dial to adjust the audio tone.</li> </ul> </li> </ul> |
|--|---|

### ◇ About the 5 MHz frequency band operation (USA version only)

Operation on the 5 MHz frequency band is allowed on 5 discrete frequencies and must adhere to the following:

- The USB, USB data, CW and PSK modes
- Maximum of 100 watts ERP (Effective Radiated Power)
- 2.8 kHz bandwidth (maximum)

It is your responsibility to set all controls so that transmission in this frequency band meets the stringent conditions under which amateur operations may use these frequencies.

**NOTE:** We recommend that you store these frequencies, modes and filter settings into memory channels, for easy recall.

To assist you in operating within the rules specified by the FCC, transmission is illegal on any frequencies other than the five shown in the tables below.

#### • For the USB and USB data modes

The FCC specifies center frequencies on the 5 MHz frequency band. However, the transceiver displays carrier frequency. Therefore, tune the transceiver to 1.5 kHz below the specified FCC channel center frequency.

Transceiver Displayed Frequency	FCC Channel Center Frequency
5.33050 MHz	5.33200 MHz
5.34650 MHz	5.34800 MHz
5.35700 MHz	5.35850 MHz
5.37150 MHz	5.37300 MHz
5.40350 MHz	5.40500 MHz

#### • For the CW and PSK modes

The transceiver displays the center frequency. Therefore, tune the transceiver to the specified FCC channel frequency when you operate in these modes.

Transceiver Displayed Frequency	FCC Channel Center Frequency
5.33200 MHz	5.33200 MHz
5.34800 MHz	5.34800 MHz
5.35850 MHz	5.35850 MHz
5.37300 MHz	5.37300 MHz
5.40500 MHz	5.40500 MHz

## Operating CW

[KEY SPEED] [TX] indicator [RX] indicator Band keys

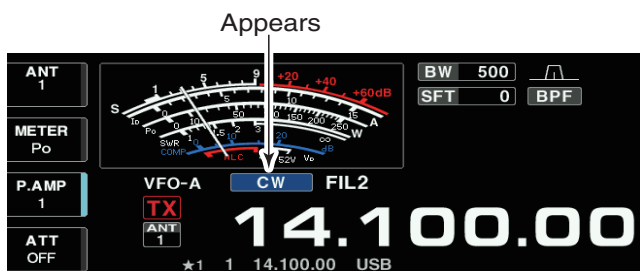
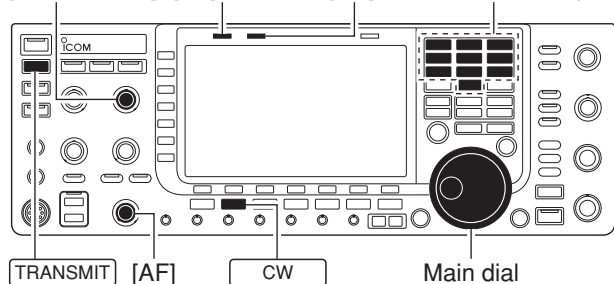

- ① Push a band key to select the desired band.
- ② Push **CW** to select CW.
  - After CW mode is selected, push **CW** to toggle between CW and CW-R modes.
  - “CW” or “CW-R” appears.
- ③ Rotate the main dial to tune a desired signal.
  - Try to match the desired signal’s tone to the side tone frequency.
  - The S-meter indicates received signal strength when signal is received.
- ④ Rotate [AF] to set audio to a comfortable listening level.
- ⑤ Push **TRANSMIT** to transmit.
  - [TX] indicator lights red.
- ⑥ Use the electric keyer or paddle to key your CW signals.
  - The power meter indicates transmitted CW output power.
- ⑦ Adjust CW speed with [KEY SPEED].
  - Adjustable within 6–48 WPM.
- ⑧ Push **TRANSMIT** to return to receive.

### Convenient functions for receive

#### • Preamp (p. 5-10)

- ➔ Push [P.AMP] (MF3) several times to set the preamp OFF, preamp 1 ON or preamp 2 ON.
  - Hold down [P.AMP] (MF3) for 1 second to turn the preamp function OFF.
  - “P.AMP1” or “P.AMP2” appears when the preamp 1 or preamp 2 is ON.

#### • Attenuator (p. 5-10)

- ➔ Push [ATT] (MF4) several times to set the attenuator in 6 dB steps.
  - Hold down [ATT] (MF4) for 1 second to turn the attenuator function OFF.
  - “ATT” and attenuation level appear when the attenuator is ON.

#### • Noise blanker (p. 5-17)

- ➔ Push **NB** to turn the noise blanker ON or OFF, and then rotate [NB] control to adjust the threshold level.
  - Noise blanker indicator (above **NB** switch) lights when the noise blanker is ON.
  - Hold down **NB** for 1 second to enter noise blanker set mode.

#### • Noise reduction (p. 5-18)

- ➔ Push **NR** to turn the noise reduction ON or OFF.
  - Rotate [NR] control to adjust the noise reduction level.
  - Noise reduction indicator (above **NR** switch) lights when the noise reduction is ON.

#### • Twin PBT (passband tuning) (p. 5-13)

- ➔ Rotate [TWIN PBT] controls (inner/outer).
  - PBT indicator (above **PBT-CLR** switch) lights when PBT is in use.
  - Hold down **PBT-CLR** for 1 second to clear the settings.

#### • Manual notch filter (p. 5-19)

- ➔ Push **NOTCH** to turn the manual notch function ON or OFF.
  - Rotate [NOTCH] control to set the attenuating frequency.
  - Notch indicator (above **NOTCH** switch) lights when the manual notch is ON.

#### • AGC (auto gain control) (p. 5-12)

- ➔ Push [AGC] switch several times to select AGC FAST, AGC MID or AGC SLOW.
- ➔ Push **AGC VR** to turn the AGC time constant manual setting ON or OFF.
  - Rotate [AGC] control to adjust the time constant.

#### • 1/4 function (p. 3-6)

- ➔ Push [1/4] to turn the 1/4 function ON or OFF.

#### • Auto tuning function (p. 5-22)

- ➔ Push [AUTOTUNE] to turn the auto tuning function ON or OFF.
  - The transceiver automatically tunes the desired signal within a ±500 Hz range.

#### **IMPORTANT!**

When receiving a weak signal, or receiving a signal with interference, the automatic tuning function may not tune properly, or tune onto an undesired signal.



### ◇ Convenient functions for transmit

#### • Break-in function (p. 6-3)

- ➔ Push **[BK-IN]** several times to select the break-in OFF, semi break-in and full break-in.
  - “**BKIN**” or “**F-BKIN**” appears when the semi break-in or full break-in function is ON, respectively.

### ● About the 5 MHz frequency band operation (USA version only)

See page 4-3 for details.

### ◇ About CW reverse mode

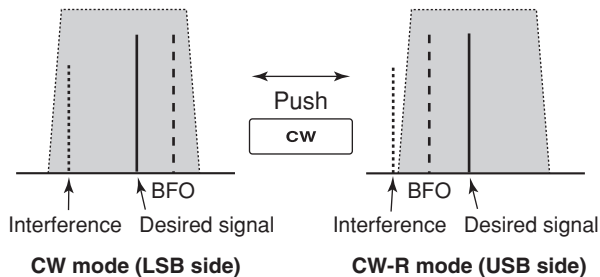

CW-R (CW Reverse) mode uses the opposite side band to receive CW signals.

Use when interfering signals are near a desired signal and you want to use CW-R to reduce the interference.

- ➔ During CW mode, push **[CW]** to select CW and CW-R mode.

### ◇ About CW pitch control

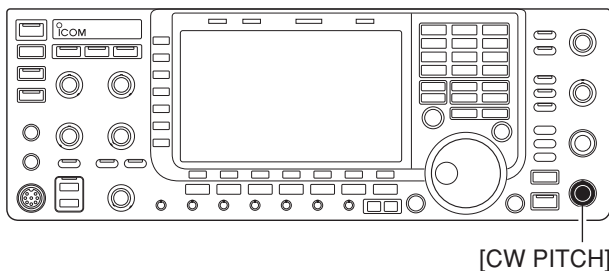

The received CW audio pitch and CW side tone can be adjusted to suit your preference (from 300 to 900 Hz in 5 Hz steps). This does not change the operating frequency.

- ➔ Rotate **[CW PITCH]** to suit your preference.
  - Adjustable within 300 to 900 Hz in 5 Hz steps.

### • Filter set screen



The filter set screen graphically displays the CW pitch operations. (see at left)

- ➔ Hold down **[FILTER]** for 1 second to access the filter set screen.
  - The CW pitch frequency is graphically changed in 5 Hz steps when the selected IF filter passband width is below 500Hz (“**BPF**” appears), or in 25 Hz steps when the selected IF filter passband width is above 600Hz (“**BPF**” disappears).
  - Push **[EXIT/SET]** or hold down **[FILTER]** for 1 second to return to the previous screen.

### ◇ CW side tone function

When the transceiver is in receive (and the break-in function is OFF— p. 6-3) you can listen to the CW side tone without actually transmitting.

This allows you to match your transmit frequency exactly to another station’s by matching the audio tone. You can also use the CW side tone (be sure to turn OFF break-in!) to practice CW sending. CW side tone level can be adjusted in level set mode (p. 12-6).

Matching the frequency of a transmitted and received signal is called “Zero beat”

### ◇ APF (Audio Peak Filter) operation

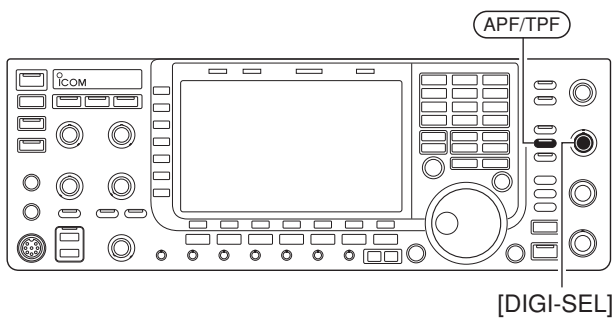

The APF changes the audio frequency response by boosting a particular frequency to enhance a desired CW signal.

The peak frequency can be adjusted with [DIGI-SEL] control when “APF” is selected for “DIGI-SEL VR Operation” in Others set mode (p. 12-15).

The APF audio level can be adjusted in the Level set mode (p. 12-6).

The audio filter shape is also selectable from “SOFT” and “SHARP” in Others set mode (p. 12-16).

- ① During CW mode, push **APF/TPF** to turn the audio peak filter ON or OFF.
  - “**APF**” appears in the display and [APF/TPF] indicator above this switch lights green.
- ② Hold down **APF/TPF** for 1 second several times to select the desired audio filter width.
  - WIDE, MID and NAR filters, or, 320, 160 and 80 Hz filters are available depending on APF type setting in Other set mode. (p. 12-16)
- ③ If “APF” is selected for “DIGI-SEL VR Operation,” rotate [DIGI-SEL] control to suit your preference.

## Electronic keyer functions

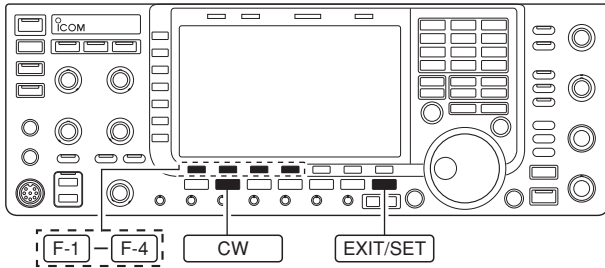

The IC-7700 has a number of convenient functions for the built-in electronic keyer.

- ① During CW mode, push **EXIT/SET** several times to normal screen, if necessary.
- ② Push **[KEYER] [F-3]** to select memory keyer screen.
- ③ Push **EXIT/SET** to select memory keyer menu screen.
- ④ Push one of the LCD function switches (**[F-1]** to **[F-4]**) to select the desired menu. See the diagram below.
  - Push **EXIT/SET** to return to the previous display.



### • Memory keyer screen (p. 4-8)



### • Memory keyer edit screen (p. 4-9)

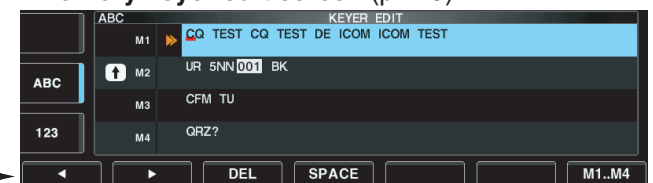

### • Memory keyer menu screen

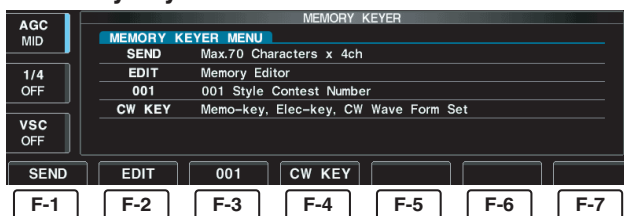

### • Contest number set mode (p. 4-10)



### • Keyer set mode screen (p. 4-11)

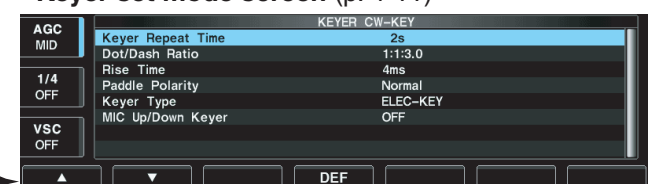

◇ Memory keyer screen

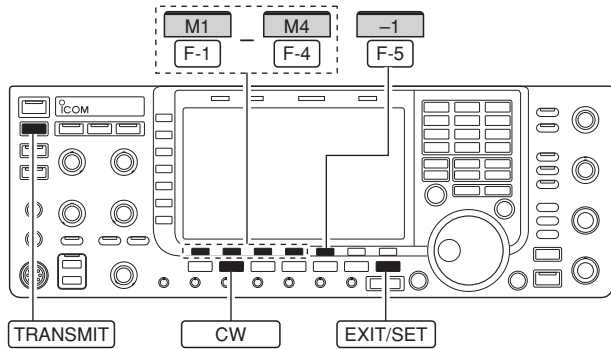

• Memory keyer screen



Pre-set characters can be sent using the keyer send menu. Contents of the memory keyer are set using the edit menu.

• Transmitting

- ① During CW mode operation, push [KEYER] [F-3] to select memory keyer screen.
- ② Push [TRANSMIT] to set the transceiver to transmit, or set the break-in function ON (p. 6-3).
- ③ Push one of the function keys ([M1] [F-1] to [M4] [F-4]) to send the contents of the memory keyer.
  - Holding down a function key for 1 second repeatedly sends the contents; push any function key to cancel the transmission.
  - The contest serial number counter is incremented each time the contents are sent.
  - Push [-1] [F-5] to reduce the contest serial number count by 1 before sending the contents of the memory keyer to a station a second time.

**For your information**

When an external keypad or USB keyboard is connected, the programmed contents, M1—M4, can be transmitted without selecting the memory keyer screen. See pages 2-6, 2-7, 12-16 and 12-17 for details.

- ④ Push [EXIT/SET] twice to return to normal screen.

◇ Editing a memory keyer

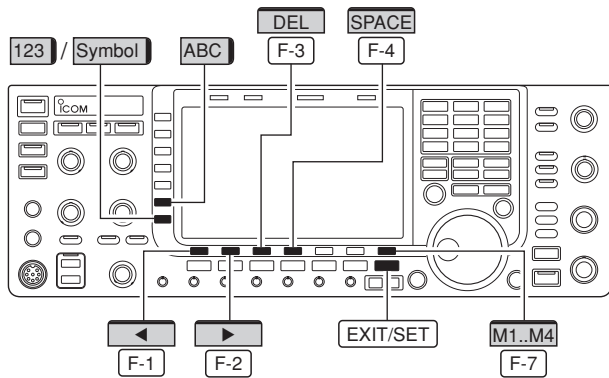

• Memory keyer edit screen

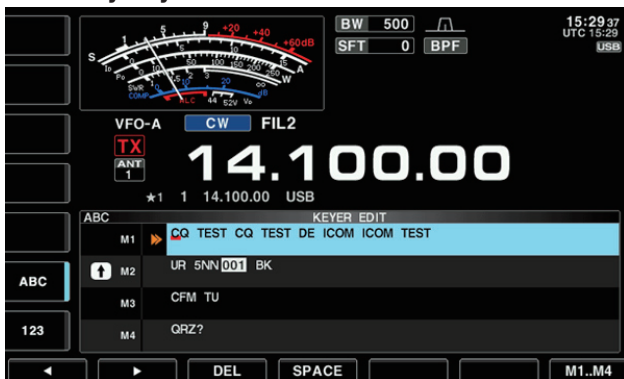

• Example— entered “QSL TU DE JA3YUA TEST” into memory keyer channel 3



• Pre-programmed contents

CH	Contents
M1	CQ TEST CQ TEST DE ICOM ICOM TEST
M2	UR 5NN* BK
M3	CFM TU
M4	QRZ?

The contents of the memory keyer memories can be set using the memory keyer edit menu. The memory keyer can memorize and re-transmit 4 CW key codes for often-used CW sentences, contest serial numbers, etc. Total capacity of the memory keyer is 70 characters per memory channel.

• Programming contents

- ① During CW mode operation, push [KEYER] [F-3] to select memory keyer screen.
- ② Push [EXIT/SET] to select memory keyer menu, then push [EDIT] [F-2] to select keyer edit screen.
  - Memory keyer contents of Channel 1 (M1) is selected.
- ③ Push [M1..M4] [F-7] several times to select the desired memory keyer channel to be edited.
- ④ Push [ABC] (MF6) or [123] (MF7) or [Symbol] (MF7) to select the character group, then rotate the main dial to select the character, or push the keypad for number input.
  - [Symbol] appears when [123] (MF7) is pushed when “123” character group is selected.
  - Selectable characters (using the main dial);

Key selection	Editable characters
ABC	A to Z (capital letters)
123	0 to 9 (numbers)
Symbol	/ ? ^ . , @ *

NOTE:

“^” is used to transmit a string of characters with no inter-character space. Put “^” before a text string such as ^AR, and the string “AR” is sent with no space.

“\*” is used to insert the CW contest serial number. The serial number automatically increments by 1. This function is only available for one memory keyer channel at a time. Memory keyer channel M2 used “\*” by default.

✓ For your convenience

When a PC keyboard is connected to [USB] connector on the front panel, the memory keyer contents can also be edited from the keyboard.

- ⑤ Push [◀] [F-1] or [▶] [F-2] to move the cursor backwards or forwards, respectively.
  - Pushing [DEL] [F-3] deletes a character and [SPACE] [F-4] inserts a space.
- ⑥ Repeat steps ④ and ⑤ to input the desired characters.
- ⑦ Push [EXIT/SET] twice to return normal screen.

◇ Contest number set mode

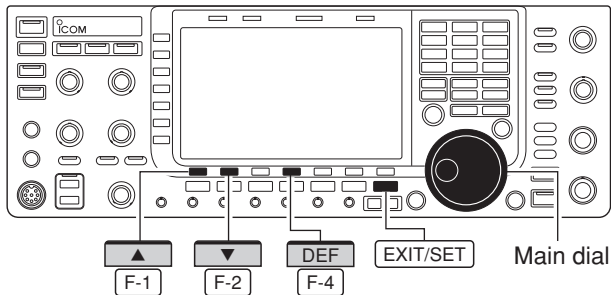

• Contest number set mode screen



This menu is used to set the contest (serial) number and count-up trigger, etc.

• Setting contents

- ① During CW mode operation, push [KEYER] [F-3] to select memory keyer screen.
- ② Push [EXIT/SET] to select memory keyer menu, then push [001] [F-3] to select contest serial number set mode.
- ③ Push [▲] [F-1] or [▼] [F-2] to select the desired set item.
- ④ Set the desired condition using the main dial.
  - Hold down [DEF] [F-4] for 1 second to select the default condition or value.
- ⑤ Push [EXIT/SET] twice to normal screen.

<b>Number Style</b>	<b>Normal</b>
<p>This item sets the numbering system used for contest (serial) numbers— normal or short morse numbers.</p> <p>Short morse numbers are also referred to as “cut” numbers.</p>	<ul style="list-style-type: none"> <li>• Normal : Does not use short morse numbers (default)</li> <li>• 190→ANO : Sets 1 as A, 9 as N and 0 as O.</li> <li>• 190→ANT : Sets 1 as A, 9 as N and 0 as T.</li> <li>• 90→ NO : Sets 9 as N and 0 as O.</li> <li>• 90→ NT : Sets 9 as N and 0 as T.</li> </ul>
<b>Count Up Trigger</b>	<b>M2</b>
<p>This selects which of the four memories will contain the contest serial number exchange. The count-up trigger allows the serial number to automatically increment after each complete serial number exchange is sent.</p>	<ul style="list-style-type: none"> <li>• M1, M2, M3 and M4 can be set. (default: M2)</li> </ul>
<b>Present Number</b>	<b>001</b>
<p>This item shows the current number for the count-up trigger channel set above.</p>	<ul style="list-style-type: none"> <li>• Rotate the main dial to change the number, or hold down [001CLR] [F-4] for 1 second to reset the current number to 001.</li> </ul>

◇ **Keyer set mode**

This set mode is used to set the memory keyer repeat time, dash weight, paddle specifications, keyer type, etc.

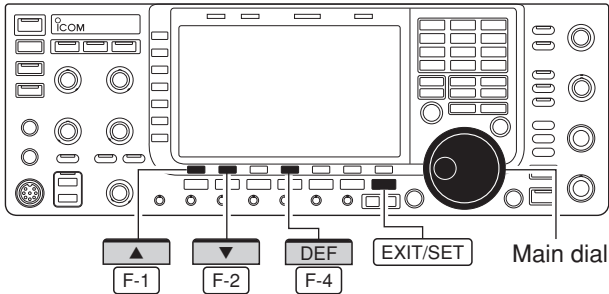

• **Setting contents**

- ① During CW mode operation, push [KEYER] [F-3] to select memory keyer screen.
- ② Push [EXIT/SET] to select memory keyer menu, then push [CW KEY] [F-4] to select keyer set mode.
- ③ Push [▲] [F-1] or [▼] [F-2] to select the desired set item.
- ④ Set the desired condition using the main dial.
  - Hold down [DEF] [F-4] for 1 second to select the default condition or value.
- ⑤ Push [EXIT/SET] twice to normal screen.

• **Keyer set mode screen**



<b>Keyer Repeat Time</b>	<b>2s</b>
When sending CW using the repeat timer, this item sets the time between transmission.	<ul style="list-style-type: none"> <li>• 1 to 60 seconds in 1 second steps can be selected. (default: 2 seconds)</li> </ul>
<b>Dot/Dash Ratio</b>	<b>1:1:3.0</b>
This item sets the dot/dash ratio. <b>Keying weight example: Morse code "K"</b>	<ul style="list-style-type: none"> <li>• 1:1:2.8 to 1:1:4.5 (in 0.1 steps) can be selected. (default: 1:1:3.0)</li> </ul>
<b>Rise Time</b>	<b>4ms</b>
This item sets the rise time of the transmitted CW envelope.	<ul style="list-style-type: none"> <li>• 2, 4, 6 or 8 milliseconds can be selected. (default: 4 milliseconds)</li> </ul>
<ul style="list-style-type: none"> <li>• <b>About rise time</b></li> </ul>	<ul style="list-style-type: none"> <li>▨ Key clicks on nearby frequencies can be generated if the rise time of a CW waveform is too short.</li> </ul>

to be continued...

◇ **Keyer set mode (continued)**

<b>Paddle Polarity</b>	<b>Normal</b>
This item sets the paddle dot-dash polarity.	<ul style="list-style-type: none"> <li>• Normal and reverse polarity can be selected.</li> </ul>
<b>Keyer Type</b>	<b>ELEC-KEY</b>
This item selects the keyer type for [ELEC-KEY] connector on the front panel.	<ul style="list-style-type: none"> <li>• ELEC-KEY, BUG-KEY and Straight key can be selected. (default: ELEC-KEY)</li> </ul>
<b>Mic Up/Down Keyer</b>	<b>OFF</b>
This item allows you to set the microphone [UP]/[DN] keys to be used as a paddle.	<ul style="list-style-type: none"> <li>• ON : [UP]/[DN] switches can be used for CW.</li> <li>• OFF : [UP]/[DN] switches cannot be used for CW.</li> </ul> <p><b>NOTE:</b> When “ON” is selected, the frequency and memory channel cannot be changed using the [UP]/[DN] switches.</p>



## ■ Operating RTTY (FSK)

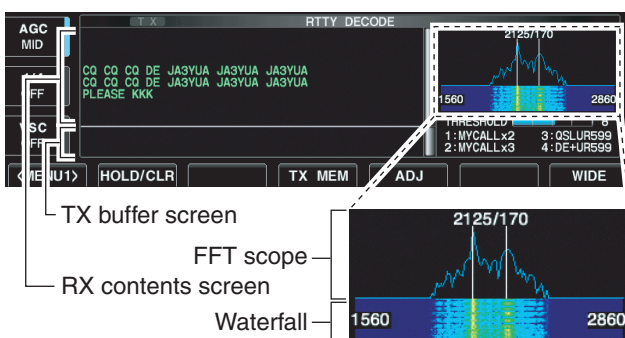
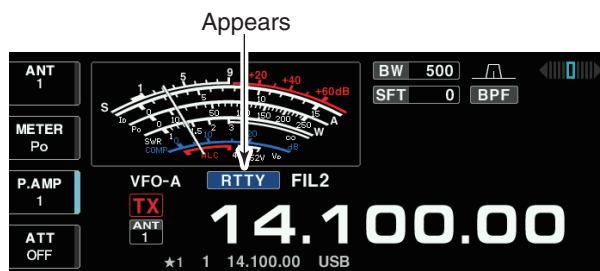
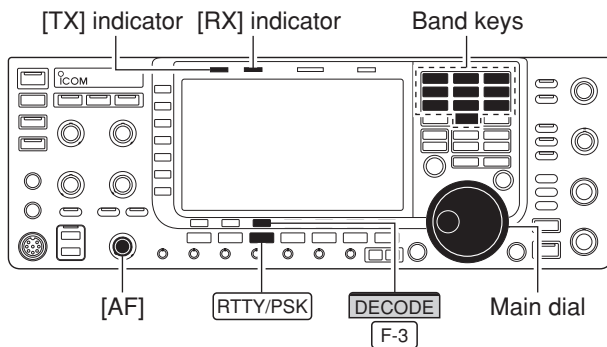

A DSP-based high-quality Baudot RTTY encoder/decoder is built-in to the IC-7700. When connecting a PC keyboard (p. 2-6), you can operate RTTY without an external RTTY terminal or PC.

If you would rather use your RTTY terminal, consult the manual that comes with the RTTY terminal.

- ① Push a band key to select the desired band.
- ② Push [RTTY/PSK] to select RTTY.
  - After RTTY mode is selected, hold down [RTTY/PSK] for 1 second to toggle between RTTY and RTTY-R modes.
  - “RTTY” or “RTTY-R” appears.
- ③ Push [DECODE] [F-3] to display the decode screen.
  - The IC-7700 has a built-in Baudot decoder.
- ④ Rotate the main dial to tune the desired signal.
  - Aim for a symmetrical waveform, and ensure the peak points align with the mark (2125 Hz) and shift (170 Hz) frequency lines in the FFT scope.
  - The S-meter indicates received signal strength when signal is received.
- ⑤ Press [F12] on the connected keyboard to transmit.
  - [TX] indicator lights red.
- ⑥ Type from the keyboard to enter the contents that you want to transmit.
  - The typewritten contents are indicated in the TX buffer screen and transmitted immediately.
  - The text color will change when transmitted.
  - Press one of [F1]–[F8] to transmit the TX memory contents.
- ⑦ Press [F12] on the keyboard to return to receive.

### ✓ For your convenience

The transmission contents can be typed before being transmitted.

- ① Perform the steps ① to ④ above.
- ② Type from the connected keyboard to enter the message that you want to transmit.
  - The typewritten contents are displayed in the TX buffer screen.
- ③ Press [F12] of the connected keyboard to transmit the typewritten contents.
  - The color of displayed text, in the TX buffer screen, will change when transmitted.
  - To cancel the transmission, press [F12] twice.
- ④ Press [F12] of the keyboard to return to receive.

◇ Convenient functions for receive

- **Preamp** (p. 5-10)
  - ➔ Push [P.AMP] (MF3) several times to set the preamp OFF, preamp 1 ON or preamp 2 ON.
    - Hold down [P.AMP] (MF3) for 1 second to turn the preamp function OFF.
    - “P.AMP1” or “P.AMP2” appears when the preamp 1 or preamp 2 is ON.
- **Attenuator** (p. 5-10)
  - ➔ Push [ATT] (MF4) several times to set the attenuator in 6 dB steps.
    - Hold down [ATT] (MF4) for 1 second to turn the attenuator function OFF.
    - “ATT” and attenuation level appear when the attenuator is ON.
- **Noise blanker** (p. 5-17)
  - ➔ Push [NB] to turn the noise blanker ON or OFF, and then rotate [NB] control to adjust the threshold level.
    - Noise blanker indicator (above [NB] switch) lights when the noise blanker is ON.
    - Hold down [NB] for 1 second to enter noise blanker set mode.
- **Twin PBT (passband tuning)** (p. 5-13)
  - ➔ Rotate [TWIN PBT] controls (inner/outer).
    - PBT indicator (above [PBT-CLR] switch) lights when PBT is in use.
    - Hold down [PBT-CLR] for 1 second to clear the settings.
- **Noise reduction** (p. 5-18)
  - ➔ Push [NR] to turn the noise reduction ON or OFF.
    - Rotate [NR] control to adjust the noise reduction level.
    - Noise reduction indicator (above [NR] switch) lights when the noise reduction is ON.
- **Manual notch filter** (p. 5-19)
  - ➔ Push [NOTCH] to turn the manual notch function ON or OFF.
    - Rotate [NOTCH] control to set the attenuating frequency.
    - Notch indicator (above [NOTCH] switch) lights when the manual notch is ON.
- **AGC (auto gain control)** (p. 5-12)
  - ➔ Push [AGC] switch several times to select AGC FAST, AGC MID or AGC SLOW.
    - Rotate [AGC] control to adjust the time constant.
- **1/4 function** (p. 3-6)
  - ➔ Push [1/4] to turn the 1/4 function ON or OFF.

◇ About RTTY reverse mode

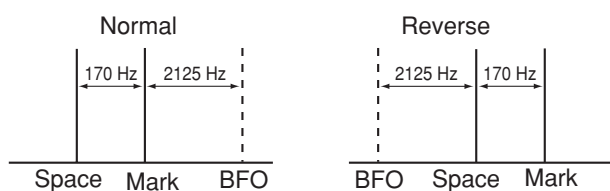

Received characters are occasionally garbled when the received signal has Mark and Space tones reversed. This reversal can be caused by incorrect TNC connections, setting, commands, etc. To receive reversed RTTY signals correctly, select RTTY-R mode.

- ➔ During RTTY mode, hold down [RTTY/PSK] for 1 second to select RTTY and RTTY-R mode.

◇ Twin peak filter

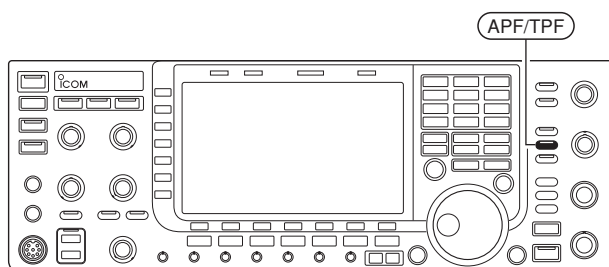

The twin peak filter changes audio frequency response by boosting the mark and space frequencies (2125 and 2295 Hz) for better reception of RTTY signals.

- ➔ During RTTY mode, push [APF/TPF] to turn the twin peak filter ON or OFF.
  - “TPF” appears in the LCD and the [APF/TPF] indicator above this switch lights green while the filter is in use.

**NOTE:** When the twin peak filter is in use, the received audio output may increase. This is a normal, not a malfunction.

### ◇ Functions for the RTTY decoder display

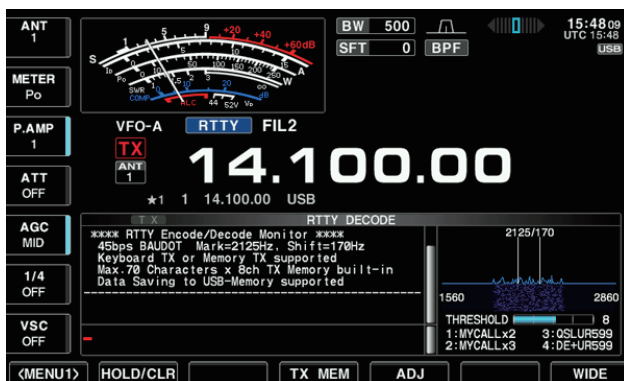
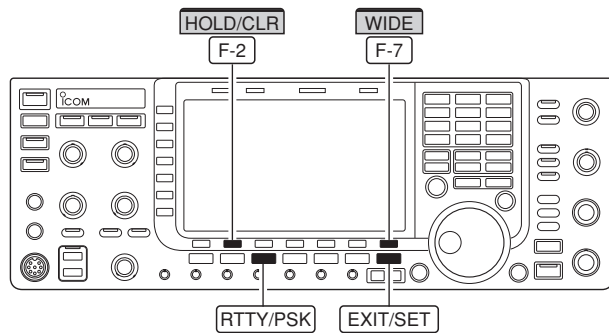

#### • Wide screen display

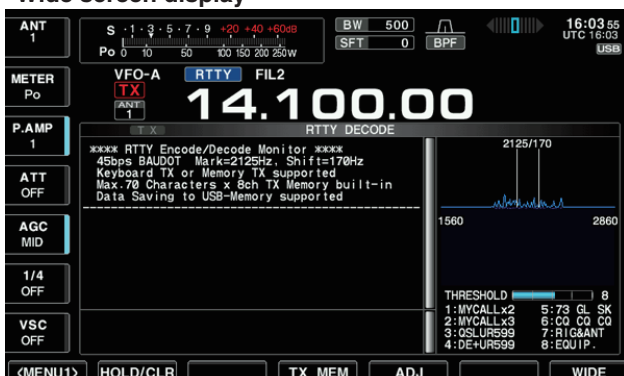

### ◇ Setting the decoder threshold level



- ① Push a band key to select the desired band.
- ② Push [RTTY/PSK] to select RTTY.
  - After RTTY mode is selected, hold down [RTTY/PSK] for 1 second to toggle between RTTY and RTTY-R modes.
  - “RTTY” or “RTTY-R” appears.
- ③ Push [DECODE] [F-3] to display the decode screen.
  - When tuned into an RTTY signal, decoded characters are displayed in the RX contents screen.
- ④ Push [HOLD/CLR] [F-2] to freeze the current screen.
  - “HOLD” appears while the function is in use.
  - Push [HOLD/CLR] [F-2] again to release the function.
- ⑤ Hold down [HOLD/CLR] [F-2] for 1 second to clear the displayed characters.
  - “HOLD” indicator disappears at the same time when the displayed characters are cleared. (The hold function is cancelled.)
- ⑥ Push [WIDE] [F-7] to toggle the RTTY decode screen size between normal and wide.
  - S/R/F meter type during wide screen display can be selected in display set mode. (pp. 3-11, 12-10)
- ⑦ Push [EXIT/SET] to close the RTTY decode screen.

Adjust the RTTY decoder threshold level if some characters are displayed when no signal is received.

- ① Select the RTTY decode screen as described above.
- ② Push [ADJ] [F-5] to select the threshold level setting condition.
- ③ Rotate the main dial to adjust the RTTY decoder threshold level.
  - Hold down [DEF] [F-6] for 1 second to select the default setting.
- ④ Push [ADJ] [F-5] to exit from the threshold level setting condition.

▨ The UnShift On Space (USOS) function and new line code can be set in the RTTY set mode. (p. 4-18)



◇ Editing RTTY memory

The contents of the RTTY memories can be set using the memory edit menu. The memory can store and re-transmit 8 RTTY message for often-used RTTY information. Total capacity of the memory is 70 characters per memory channel.

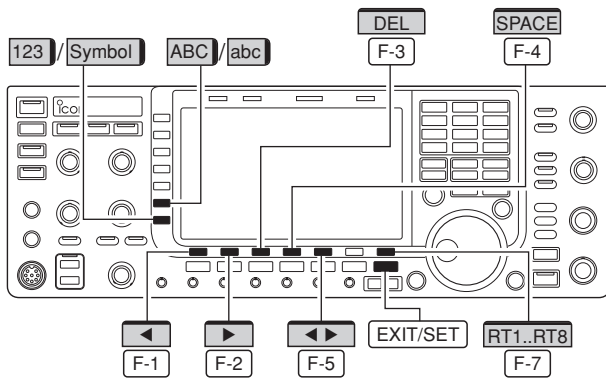

• RTTY memory edit screen

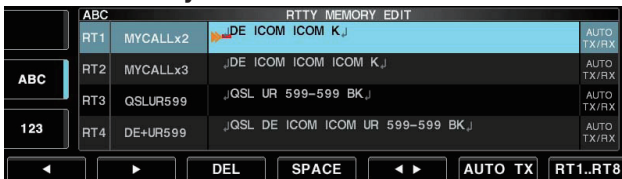

• Pre-programmed contents

CH	Name	Contents
RT1	MYCALLx2	↓DE ICOM ICOM K↓
RT2	MYCALLx3	↓DE ICOM ICOM ICOM K↓
RT3	QSLUR599	↓QSL UR 599-599 BK↓
RT4	DE+UR599	↓QSL DE ICOM ICOM UR 599-599 BK↓
RT5	73 GL SK	↓73 GL SK↓
RT6	CQ CQ CQ	↓CQ CQ CQ DE ICOM ICOM ICOM K↓
RT7	RIG&ANT	↓MY TRANSCEIVER IS IC-7700 & ANTENNA IS A 3-ELEMENT TRIBAND YAGI.↓
RT8	EQUIP.	↓MY RTTY EQUIPMENT IS INTERNAL FSK UNIT & DEMODULATOR OF THE IC-7700.↓

• Programming contents

- ① During RTTY mode operation, push [DECODE] [F-3] to select RTTY decode screen.
- ② Push [TX MEM] [F-4] to select RTTY memory screen, then push [EDIT] [F-6] to select RTTY memory edit screen.
  - RTTY memory contents of Channel 1 (RT1) is selected.
- ③ Push [RT1..RT8] [F-7] several times to select the desired RTTY memory channel to be edited.
- ④ Push [◀▶] [F-5] to select between memory contents and memory name.
- ⑤ Push [ABC] (MF6), [abc] (MF6), [123] (MF7) or [Symbol] (MF7) to select the character group, then rotate the main dial to select the character, or push the keypad for number input.

- [abc] (MF6) appears when [ABC] (MF6) is pushed when “ABC” character group is selected, and [Symbol] (MF7) appears when [123] (MF7) is pushed when “123” character group is selected.

- Selectable characters (with the main dial);

Key selection	Editable characters
ABC	A to Z (capital letters)
abc	a to z (small letters) (selectable for memory name only)
123	0 to 9 (numbers)
Symbol	! # \$ % & ¥ ? “ ‘ ^ + - * / . , ; = < > ( ) [ ] { }   _ ~ @ (For the memory contents setting, ! \$ & ? “ ‘ - / . , ; ( ) ↓ are selectable.)

✓ For your convenience

When a PC keyboard is connected to [USB] connector on the front panel, the RTTY memory contents can also be edited from the keyboard.

- ⑥ Push [◀] [F-1] or [▶] [F-2] to move the cursor backwards or forwards, respectively.
  - Pushing [DEL] [F-3] deletes a character and [SPACE] [F-4] inserts a space.
- ⑦ Repeat steps ⑤ and ⑥ to input the desired characters.
- ⑧ Push [EXIT/SET] to set the contents and exit RTTY memory edit screen.

◇ RTTY decode set mode

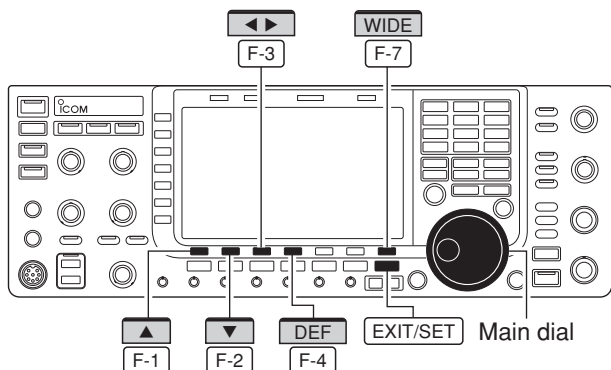

• RTTY decode set mode screen







This set mode is used to set the decode USOS function, time stamp setting, etc.

• Setting contents

- ① During RTTY mode operation, push [DECODE] [F-3] to select RTTY decode screen.
- ② Push [<MENU1>] [F-1] to select the second RTTY decode menu, then push [SET] [F-6] to select RTTY decode set mode.
  - Push [WIDE] [F-7] to toggle the screen size between normal and wide.
- ③ Push [▲] [F-1] or [▼] [F-2] to select the desired set item.
- ④ Set the desired condition using the main dial.
  - Hold down [DEF] [F-4] for 1 second to select a default condition or value.
  - Push [◀▶] [F-3] to select the set contents for some items.
- ⑤ Push [EXIT/SET] to exit from set mode.

<b>RTTY FFT Scope Averaging</b>	<b>OFF</b>
Select the FFT scope waveform averaging function from 2 to 4 and OFF. (default: OFF)	<b>Recommendation!</b> If you use the FFT scope waveform for tuning, use of the default or smaller averaging setting is recommended.
<b>RTTY FFT Scope Waveform Color</b>	
Set the color for the FFT scope waveform. <ul style="list-style-type: none"> <li>• The color is set in RGB format.</li> <li>• The set color is indicated in the box beside the RGB scale.</li> </ul>	<ul style="list-style-type: none"> <li>• Push [◀▶] [F-3] to select R (Red), G (Green) and B (Blue), and then rotate the main dial to set the ratio from 0 to 255.</li> </ul>
<b>RTTY Decode USOS</b>	<b>ON</b>
Turn the capability of letter code decoding after receiving a “space” (USOS; UnShift On Space function) ON or OFF.	<ul style="list-style-type: none"> <li>• ON : Decode as letter code.</li> <li>• OFF : Decode as character code.</li> </ul>
<b>RTTY Decode New Line Code</b>	<b>CR,LF,CR+LF</b>
Selects the new line code of the internal RTTY decoder. CR: Carriage Return, LF: Line Feed	<ul style="list-style-type: none"> <li>• CR,LF,CR+LF : Makes new line with any codes.</li> <li>• CR+LF : Makes new line with CR+LF code only.</li> </ul>
<b>RTTY Diddle</b>	<b>BLANK</b>
Selects the diddle condition.	<ul style="list-style-type: none"> <li>• BLANK : Transmits blank code during no code transmission.</li> <li>• LTRS : Transmits letter code during no code transmission.</li> <li>• OFF : Turns the diddle function OFF.</li> </ul>

## ◇ RTTY decode set mode (continued)

<b>RTTY TX USOS</b> <span style="float: right;"><b>ON</b></span>	
Explicitly inserts the FIGS character even though it is not required by the receiving station.	<ul style="list-style-type: none"> <li>• ON : Inserts FIGS.</li> <li>• OFF : Does not insert FIGS.</li> </ul>
<b>RTTY Time Stamp</b> <span style="float: right;"><b>ON</b></span>	
Turn the time stamp (date, transmission or reception time) indication ON or OFF.	<ul style="list-style-type: none"> <li>• ON : Displays the time stamp.</li> <li>• OFF : No time stamp indication.</li> </ul>
<b>RTTY Auto CR+LF by TX</b> <span style="float: right;"><b>ON</b></span>	
Selects the automatic new line code (CR+LF) transmission capability.	<ul style="list-style-type: none"> <li>• ON : Transmits CR+LF code once.</li> <li>• OFF : Transmits no CR+LF code.</li> </ul>
<b>RTTY Time Stamp (Time)</b> <span style="float: right;"><b>Local</b></span>	
Selects the clock indication for time stamp usage. <b>NOTE:</b> The time won't be displayed when "OFF" is selected in "RTTY Time Stamp" as above.	<ul style="list-style-type: none"> <li>• Local : Selects the time that is set in "Time (Now)."</li> <li>• UTC* : Selects the time that is set in "CLOCK2."</li> </ul> <p>*The name of choice may differ according to "CLOCK2 Name" setting (p. 11-2). "UTC" is the default name of CLOCK2.</p>
<b>RTTY Time Stamp (Frequency)</b> <span style="float: right;"><b>OFF</b></span>	
Selects the operating frequency display for time stamp usage. <b>NOTE:</b> The frequency won't be displayed when "OFF" is selected in "RTTY Time Stamp" as above.	<ul style="list-style-type: none"> <li>• ON : Displays the operating frequency.</li> <li>• OFF : No operating frequency display.</li> </ul>
<b>RTTY Font Color (Receive)</b> <span style="float: right;"></span>	
Set the text color for received characters. <ul style="list-style-type: none"> <li>• The color is set in RGB format.</li> <li>• The set color is indicated in the box beside the RGB scale.</li> </ul>	<ul style="list-style-type: none"> <li>• ON : Displays the operating frequency.</li> <li>• OFF : No operating frequency display.</li> </ul>
<b>RTTY Font Color (Transmit)</b> <span style="float: right;"></span>	
Set the text color for received characters. <ul style="list-style-type: none"> <li>• The color is set in RGB format.</li> <li>• The set color is indicated in the box beside the RGB scale.</li> </ul>	<ul style="list-style-type: none"> <li>• Push [◀ ▶] [F-3] to select R (Red), G (Green) and B (Blue), and then rotate the main dial to set the ratio from 0 to 255.</li> </ul>
<b>RTTY Font Color (Time Stamp)</b> <span style="float: right;"></span>	
Set the text color for transmitted characters. <ul style="list-style-type: none"> <li>• The color is set in RGB format.</li> <li>• The set color is indicated in the box beside the RGB scale.</li> </ul>	<ul style="list-style-type: none"> <li>• Push [◀ ▶] [F-3] to select R (Red), G (Green) and B (Blue), and then rotate the main dial to set the ratio from 0 to 255.</li> </ul>
<b>RTTY Font Color (TX Buffer)</b> <span style="float: right;"></span>	
Set the text color in the TX buffer screen. <ul style="list-style-type: none"> <li>• The color is set in RGB format.</li> <li>• The set color is indicated in the box beside the RGB scale.</li> </ul>	<ul style="list-style-type: none"> <li>• Push [◀ ▶] [F-3] to select R (Red), G (Green) and B (Blue), and then rotate the main dial to set the ratio from 0 to 255.</li> </ul>

◇ Data saving

The USB flash drive is not supplied by Icom.

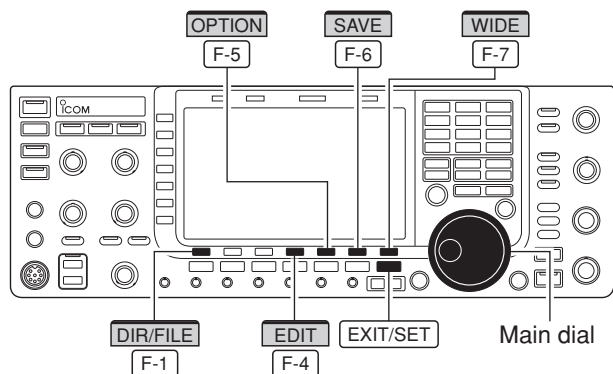

• Decode file save screen

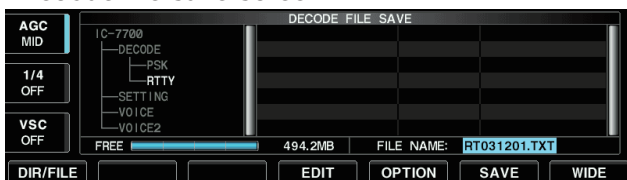

• Decode file save screen— file name edit

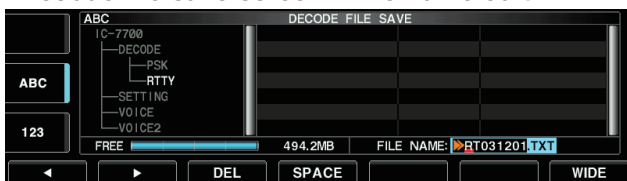

• Save option screen

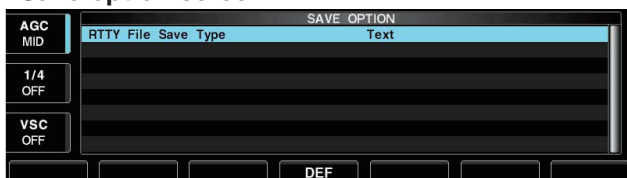

When a PC keyboard is connected to the [USB] connector on the front panel, the file name can also be edited from the keyboard.

The contents of the RTTY memory and received signal can be saved into the USB flash drive.

- ① During RTTY decode screen display, push [**<MENU1>**] [F-1] to select the RTTY decode second menu.
- ② Push [SAVE] [F-6] to select decode file save screen.
- ③ Change the following conditions, if desired.

• File name:

- ① Push [EDIT] [F-4] to select file name edit condition.
  - Push [DIR/FILE] [F-1] several times to select the file name, if necessary.
- ② Push [ABC] (MF6), [123] or [Symbol] (MF7) to select the character group, then rotate the main dial to select the character.
  - [ABC] (MF6): A to Z (capital letters); [123] (MF7): 0 to 9 (numerals); [Symbol] (MF7): ! # \$ % & ' ` ^ - ( ) { } \_ ~ @ can be selected.
  - Push [◀] [F-1] to move the cursor left, push [▶] [F-2] to move the cursor right, [DEL] [F-3] delete a character and push [SPACE] [F-4] to insert a space.
- ③ Push [EXIT/SET] to set the file name.

• File format

- ① Push [OPTION] [F-5] to enter save option screen.
- ② Rotate the main dial to select the saving format from Text or HTML.
  - “Text” is the default setting.
  - Hold down [DEF] [F-4] for 1 second to select the default setting.
- ③ Push [EXIT/SET] to return to the previous screen.

• Saving location

- ① Push [DIR/FILE] [F-1] to select tree view screen.
- ② Select the desired directory or folder in the USB flash drive.
  - Push [◀▶] [F-4] to select the upper directory.
  - Push [▲] [F-2] or [▼] [F-3] to select folder in the same directory.
  - Hold down [◀▶] [F-4] for 1 second to select a folder in the directory.
  - Push [REN/DEL] [F-5] to rename the folder.
  - Hold down [REN/DEL] [F-5] for 1 second to delete the folder.
  - Hold down [MAKE] [F-6] for 1 second to making a new folder. (Edit the name in the same manner as the “• File name” above.)

- ③ Push [DIR/FILE] [F-1] twice to select the file name.
- ④ Push [SAVE] [F-6].
  - After saving is completed, returns to RTTY decode second menu automatically.

✓ For your convenience!

Two data formats, Text and HTML, are available for PC data storage.



## ■ Operating PSK

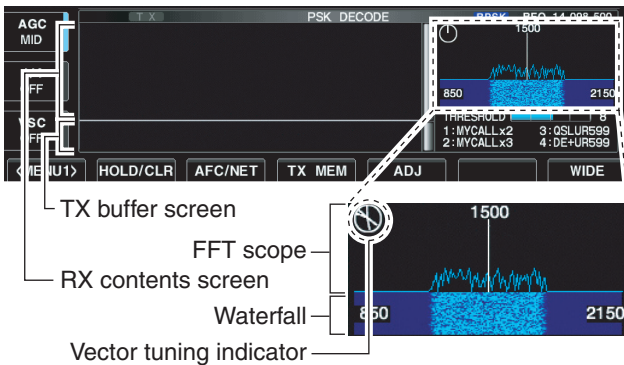
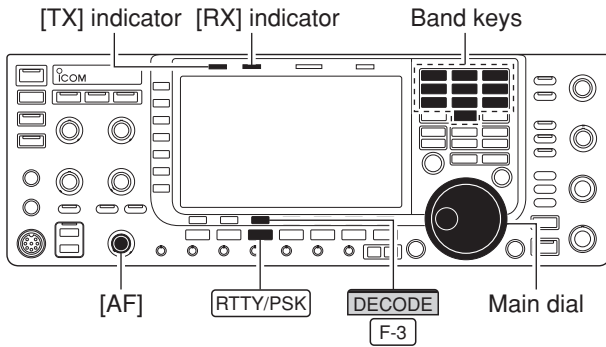

### • Vector tuning indicator display example

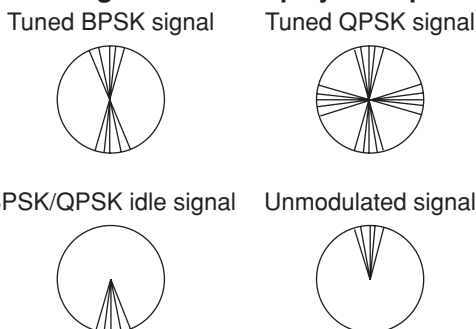

A high-quality DSP-based PSK31 encoder/decoder is built-in to the IC-7700. When connecting a PC keyboard (p. 2-6), PSK31 operation can be performed without PSK software installed on your PC.

If desired, you can also use your PSK software; consult the manual that comes with the software.

- ① Push a band key to select the desired band.
- ② Push [RTTY/PSK] to select PSK.
  - After PSK mode is selected, hold down [RTTY/PSK] for 1 second to toggle between PSK and PSK-R modes.
  - “PSK” or “PSK-R” appears.
- ③ Push [DECODE] [F-3] to display the decode screen.
  - The IC-7700 has a built-in PSK31 decoder.
- ④ Tune to the desired signal with the main dial.
  - The signal is properly tuned when the radiated lines in the vector tuning indicator narrow, as show in the example below.
  - The radiated lines in the vector tuning indicator may be displayed sporadically.
  - When a PSK signal is received, the waterfall display is activated.
  - The waterfall display shows the signals within the pass-band. Received PSK signals appear as vertical lines.
- ⑤ Press [F12] of the connected keyboard to transmit.
  - [TX] indicator lights red.
- ⑥ Type from the connected keyboard to enter the message that you want to transmit.
  - The typewritten contents are displayed in the TX buffer screen and transmitted immediately.
  - The text color will change when transmitted.
  - Press one of [F1]–[F8] to transmit the TX memory contents.
- ⑦ Press [F12] of the keyboard to return to receive.

### ✓ For your convenience

The transmission contents can be typed before being transmitted.

- ① Perform the steps ① to ④ above.
- ② Type from the connected keyboard to enter the message that you want to transmit.
  - The message is shown in the TX buffer screen.
- ③ Press [F12] of the connected keyboard to transmit the message.
  - The color of displayed text, in the TX buffer screen, will be changed when transmitted.
  - To cancel the transmission, press [F12] twice.
- ④ Press [F12] of the keyboard to return to receive.

◇ Convenient functions for receive

- **Preamp** (p. 5-10)
  - ➔ Push [P.AMP] (MF3) several times to set the preamp OFF, preamp 1 ON or preamp 2 ON.
    - Hold down [P.AMP] (MF3) for 1 second to turn the preamp function OFF.
    - “P.AMP1” or “P.AMP2” appears when the preamp 1 or preamp 2 is ON.
- **Attenuator** (p. 5-10)
  - ➔ Push [ATT] (MF4) several times to set the attenuator in 6 dB steps.
    - Hold down [ATT] (MF4) for 1 second to turn the attenuator function OFF.
    - “ATT” and attenuation level appear when the attenuator is ON.
- **Noise blanker** (p. 5-17)
  - ➔ Push [NB] to turn the noise blanker ON or OFF, and then rotate [NB] control to adjust the threshold level.
    - Noise blanker indicator (above [NB] switch) lights when the noise blanker is ON.
    - Hold down [NB] for 1 second to enter noise blanker set mode.
- **Noise reduction** (p. 5-18)
  - ➔ Push [NR] to turn the noise reduction ON or OFF.
    - Rotate [NR] control to adjust the noise reduction level.
    - Noise reduction indicator (above [NR] switch) lights when the noise reduction is ON.
- **Twin PBT (passband tuning)** (p. 5-13)
  - ➔ Rotate [TWIN PBT] controls (inner/outer).
    - PBT indicator (above [PBT-CLR] switch) lights when PBT is in use.
    - Hold down [PBT-CLR] for 1 second to clear the settings.
- **AGC (auto gain control)** (p. 5-12)
  - ➔ Push [AGC] switch several times to select AGC FAST, AGC MID or AGC SLOW.
    - ➔ Push [AGC VR] to turn the AGC time constant manual setting ON or OFF.
      - Rotate [AGC] control to adjust the time constant.
- **Manual notch filter** (p. 5-19)
  - ➔ Push [NOTCH] to turn the manual notch function ON or OFF.
    - Rotate [NOTCH] control to set the attenuating frequency.
    - Notch indicator (above [NOTCH] switch) lights when the manual notch is ON.
- **Fine tuning** (p. 3-7)
  - ➔ During PSK, make sure that the kHz tuning step function is OFF (no “▼” indication), hold down [TS] for 1 second.
    - PSK may not be decoded correctly using the 10 Hz step tuning.
- **1/4 function** (p. 3-6)
  - ➔ Push [1/4] to turn the 1/4 function ON or OFF.

● About the 5 MHz frequency band operation (USA version only)

See page 4-3 for details.

◇ About BPSK and QPSK modes

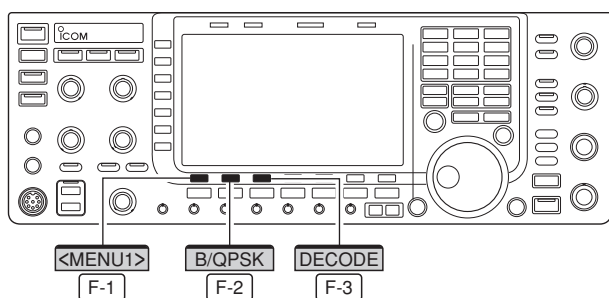

• PSK decode screen— BPSK mode

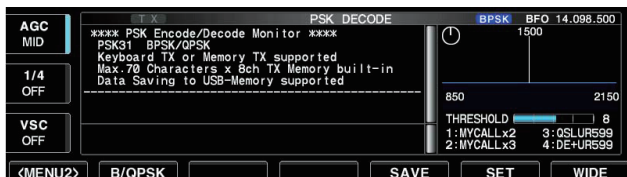

• PSK decode screen— QPSK mode



BPSK and QPSK modes are available for PSK31.

- BPSK (Binary Phase Shift Keying) mode is the most commonly used mode.
- QPSK (Quadrature Phase Shift Keying) mode has error correction capability to provide better decoding than BPSK mode in marginal condition. However, more accurate tuning is required with QPSK mode, due to the tight phase margin of QPSK.

- ① During PSK mode selection, push [DECODE] [F-3] to display the PSK decode screen.
- ② Push [<MENU1>] [F-1] to select PSK decode second menu.
- ③ Push [B/QPSK] [F-2] to toggle between BPSK and QPSK mode alternately.

### ◇ Functions for the PSK decoder display

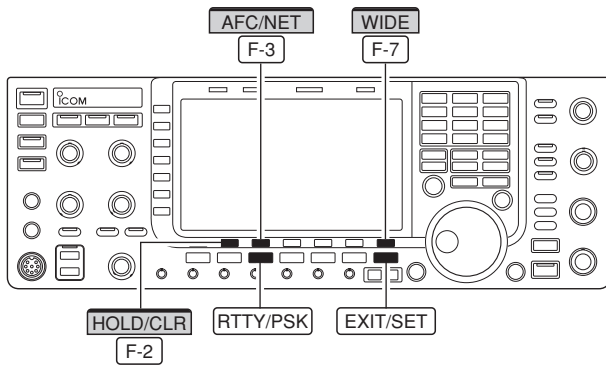

#### • AFC/NET indications

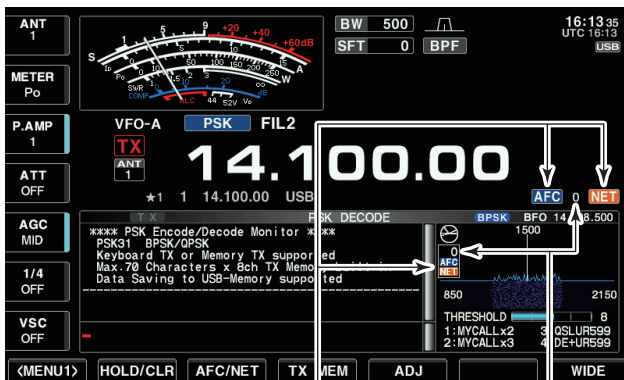

“AFC” and “NET” indicators Offset frequency

- ① Push a band key to select the desired band.
  - ② Push [RTTY/PSK] to select PSK.
    - After PSK mode is selected, hold down [RTTY/PSK] for 1 second to toggle between PSK and PSK-R modes.
    - “PSK” or “PSK-R” appears.
  - ③ Push [DECODE] [F-3] to display the decode screen.
    - When tuned into a PSK signal, decoded characters are displayed in the RX contents screen.
  - ④ Push [HOLD/CLR] [F-2] to freeze the current screen.
    - “HOLD” appears while the function is in use.
    - Push [HOLD/CLR] [F-2] again to release the function.
  - ⑤ Hold down [HOLD/CLR] [F-2] for 1 second to clear the displayed characters.
    - “HOLD” indicator disappears at the same time when the displayed characters are cleared. (The hold function is cancelled.)
  - ⑥ Push [AFC/NET] [F-3] to turn the AFC function ON.
    - “AFC” appears.
    - If a PSK signal is received within the AFC tuning range, the decoder automatically tunes into the signal and the offset frequency is displayed.
    - The AFC tuning range is set to  $\pm 15$  Hz as the default. Optional  $\pm 8$  Hz setting is available in PSK decode set mode. (p. 4-26)
- NOTE:** The AFC function may not tune the signal properly when a weak PSK signal is received.
- ⑦ Push [AFC/NET] [F-3] again to turn the NET function ON.
    - “NET” is displayed.
  - ⑧ Hold down [AFC/NET] [F-3] for 1 second to add the offset frequency to the displayed frequency.
  - ⑨ Push [WIDE] [F-7] to toggle the PSK decode screen size between normal and wide.
    - S/R/F meter type during wide screen display can be selected in display set mode. (pp. 3-11, 12-10)
  - ⑩ Push [EXIT/SET] to close the PSK decode screen.

### ◇ Setting the decoder threshold level



Adjust the PSK decoder threshold level if some characters are displayed when no signal is received.

- ① Call up the PSK decode screen as described above.
- ② Push [ADJ] [F-5] to select the threshold level setting condition.
- ③ Rotate the main dial to adjust the PSK decoder threshold level.
  - Hold down [DEF] [F-6] for 1 second to select the default setting.
- ④ Push [ADJ] [F-5] to exit from the threshold level setting condition.

◇ PSK memory transmission

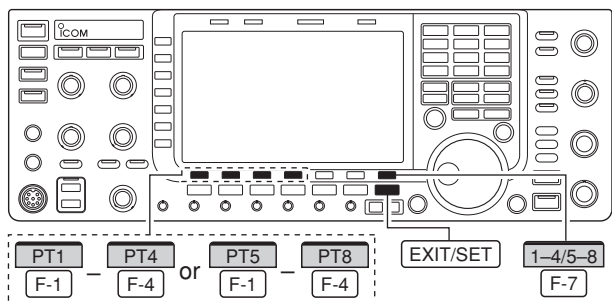

		PSK MEMORY				
AGC MID	PT1	MYCALLx2	DE Icom Icom K			AUTO TX/RX
1/4 OFF	PT2	MYCALLx3	DE Icom Icom Icom K			AUTO TX/RX
VSC OFF	PT3	QSLUR599	QSL UR 599 599 BK			AUTO TX/RX
	PT4	DE+UR599	QSL DE Icom Icom UR 599 599 BK			AUTO TX/RX
	PT1	PT2	PT3	PT4	EDIT	1-4/5-8

Previously entered characters can be sent using the PSK memory. Contents of the memory are set using the edit menu.

- ① During PSK mode operation, push [DECODE] [F-3] to select PSK decode screen.
- ② Push [TX MEM] [F-4] to select PSK memory screen.
- ③ Push [1-4/5-8] [F-7] to select memory bank then push one of the function keys ([PT1] [F-1] to [PT4] [F-4] or [PT5] [F-1] to [PT8] [F-4]).
  - When no keyboard is connected, the selected memory contents will be transmitted immediately.
  - When a keyboard is connected, the memory contents will be transmitted immediately when function key is pushed, or transmitted after [F12] on the connected keyboard is pressed, depending on auto transmission/reception setting (see below).
  - The transmission date, time, reception date and/or time may be displayed in RX contents screen, depending on setting.

**For your information**

When an external keypad is connected, the programmed contents, PT1-PT4, can be transmitted. See pages 2-7 and 12-17 for details.

◇ Automatic transmission/reception setting

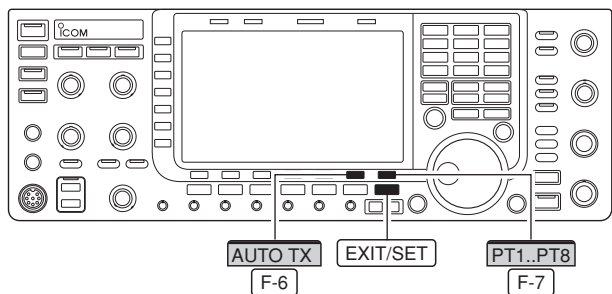

		PSK MEMORY EDIT				
ABC	PT1	MYCALLx2	DE Icom Icom K			AUTO TX/RX
ABC	PT2	MYCALLx3	DE Icom Icom Icom K			AUTO TX/RX
	PT3	QSLUR599	QSL UR 599 599 BK			AUTO TX/RX
123	PT4	DE+UR599	QSL DE Icom Icom UR 599 599 BK			AUTO TX/RX
		DEL	SPACE		AUTO TX	PT1..PT8

- ① During PSK mode operation, push [DECODE] [F-3] to select PSK decode screen.
- ② Push [TX MEM] [F-4] to select PSK memory screen, then push [EDIT] [F-6] to select PSK memory edit screen.
  - PSK memory contents of Channel 1 (PT1) is selected.
- ③ Push [PT1..PT8] [F-7] several times to select the desired PSK memory.
- ④ Push [AUTO TX] [F-6] several times to select the desired operating option, as follows.
  - **AUTO TX/RX** : Automatically transmits the selected memory contents and returns to receive after the transmission.
  - **AUTO TX** : Automatically transmits the selected memory contents. To return to receive, press [F12] on the keyboard.
  - **AUTO RX** : Press [F12] on the keyboard to transmit the selected memory contents. Automatically returns to receive after the transmission.
  - **No indication** : Press [F12] on the keyboard to transmit the selected memory contents and press [F12] again to return to receive.
- ⑤ Push [EXIT/SET] to return to exit from PSK memory edit condition.

**NOTE:** The transceiver always functions in the “AUTO TX/RX” setting when no keyboard is connected.

◇ Editing PSK memory

The contents of the PSK memories can be set using the memory edit menu. The memory can store 8 PSK messages for often-used PSK information. Total capacity of the memory is 70 characters per memory channel.

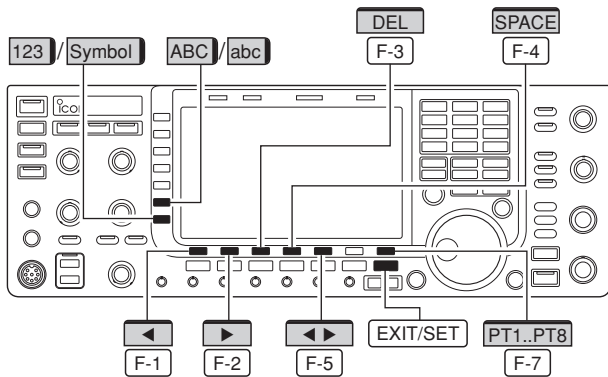

• PSK memory edit screen

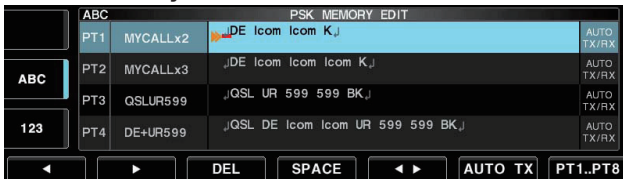

• Pre-programmed contents

CH	Name	Contents
PT1	MYCALLx2	↓DE lcom lcom K↓
PT2	MYCALLx3	↓DE lcom lcom lcom K↓
PT3	QSLUR599	↓QSL UR 599 599 BK↓
PT4	DE+UR599	↓QSL DE lcom lcom UR 599 599 BK↓
PT5	73 GL SK	↓73 GL SK↓
PT6	CQ CQ CQ	↓CQ CQ CQ DE lcom lcom lcom K↓
PT7	RIG&ANT	↓My transceiver is IC-7700 & Antenna is a 3-element triband yagi.↓
PT8	EQUIP.	↓My PSK equipment is internal modulator & demodulator of the IC-7700.↓

• Programming contents

- ① During PSK mode operation, push [DECODE] [F-3] to select PSK decode screen.
- ② Push [TX MEM] [F-4] to select PSK memory screen, then push [EDIT] [F-6] to select PSK memory edit screen.
  - PSK memory contents of Channel 1 (PT1) is selected.
- ③ Push [PT1..PT8] [F-7] several times to select the desired PSK memory channel to be edited.
- ④ Push [◀ ▶] [F-5] to select between memory contents and memory name.
- ⑤ Push [ABC] (MF6), [abc] (MF6), [123] (MF7) or [Symbol] (MF7) to select the character group, then rotate the main dial to select the character, or push the keypad for number input.
  - [abc] (MF6) appears when [ABC] (MF6) is pushed when “ABC” character group is selected, and [Symbol] (MF7) appears when [123] (MF7) is pushed when “123” character group is selected.
  - Selectable characters (with the main dial);

Key selection	Editable characters
ABC	A to Z (capital letters)
abc	a to z (small letters)
123	0 to 9 (numbers)
Symbol	! # \$ % & ¥ ? “ ` ^ + - * / . , : ; = < > ( ) [ ] { }   _ ~ @ ↓ (“↓” is for the memory contents setting only.)

✓ For your convenience

When a PC keyboard is connected to [USB] connector on the front panel, the PSK memory contents can also be edited from the keyboard.

- ⑥ Push [◀] [F-1] or [▶] [F-2] to move the cursor backwards or forwards, respectively.
  - Pushing [DEL] [F-3] deletes a character and [SPACE] [F-4] inserts a space.
- ⑦ Repeat steps ⑤ and ⑥ to input the desired characters.
- ⑧ Push [EXIT/SET] to set the contents and exit PSK memory edit screen.

◇ PSK decode set mode

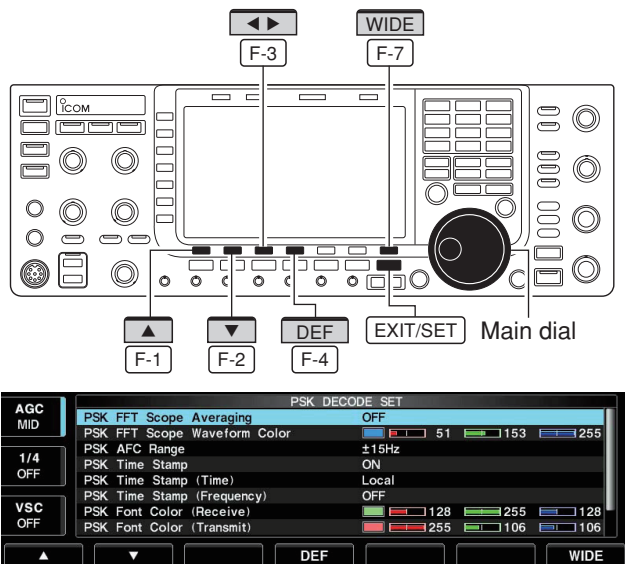





This set mode is used to set the FFT scope setting, time stamp setting, etc.

• Setting contents

- ① During PSK mode operation, push [DECODE] [F-3] to select PSK decode screen.
- ② Push [<MENU1>] [F-1] to select PSK decode second menu, then push [SET] [F-6] to select PSK decode set mode.
  - Push [WIDE] [F-7] to toggle the screen size between normal and wide.
- ③ Push [▲] [F-1] or [▼] [F-2] to select the desired set item.
- ④ Set the desired condition using the main dial.
  - Hold down [DEF] [F-4] for 1 second to select a default condition or value.
  - Push [◀▶] [F-3] to select the set contents for some items.
- ⑤ Push [EXIT/SET] to exit from set mode.

<b>PSK FFT Scope Averaging</b>	<b>OFF</b>
Select the FFT scope waveform averaging function from 2 to 4 and OFF. (default: OFF)	<b>Recommendation!</b> If you use the FFT scope waveform for tuning, using the default or smaller averaging setting is recommended.
<b>PSK FFT Scope Waveform Color</b>	
Set the color for the FFT scope waveform. <ul style="list-style-type: none"> <li>• The color is set in RGB format.</li> <li>• The set color is indicated in the box beside the RGB scale.</li> </ul>	<ul style="list-style-type: none"> <li>• Push [◀▶] [F-3] to select R (Red), G (Green) and B (Blue), and then rotate the main dial to set the ratio from 0 to 255.</li> </ul>
<b>PSK AFC Range</b>	<b>±15Hz</b>
Select the AFC (Automatic Frequency Control) function operating range from ±15 Hz (default) and ±8 Hz.	<b>NOTE:</b> The AFC function may not tune the signal properly when a weak PSK signal is received.
<b>PSK Time Stamp</b>	<b>ON</b>
Turn the time stamp (date, transmission or reception time) display ON or OFF.	<ul style="list-style-type: none"> <li>• ON : Displays the time stamp.</li> <li>• OFF : No time stamp display.</li> </ul>
<b>PSK Time Stamp (Time)</b>	<b>Local</b>
Selects the clock display for time stamp usage. <b>NOTE:</b> The time won't be displayed when "OFF" is selected in "PSK Time Stamp" as shown above.	<ul style="list-style-type: none"> <li>• Local : Selects the time that set in "Time (Now)."</li> <li>• UTC* : Selects the time that set in "CLOCK2."</li> </ul> <p>*The name of choice may differ according to "CLOCK2 Name" setting (p. 11-2). "UTC" is the default name of CLOCK2.</p>

## ◇ PSK decode set mode (continued)

<b>PSK Time Stamp (Frequency)</b>		<b>OFF</b>
<p>Selects the operating frequency display for time stamp usage.</p> <p><b>NOTE:</b> The frequency won't be displayed when "OFF" is selected in "PSK Time Stamp" as shown below left.</p>	<ul style="list-style-type: none"> <li>• ON : Displays the operating frequency.</li> <li>• OFF : No operating frequency display.</li> </ul>	
<b>PSK Font Color (Receive)</b>		
<p>Set the text color for received characters.</p> <ul style="list-style-type: none"> <li>• The color is set in RGB format.</li> <li>• The set color is indicated in the box beside the RGB scale.</li> </ul>	<ul style="list-style-type: none"> <li>• Push [◀ ▶] [F-3] to select R (Red), G (Green) and B (Blue), and then rotate the main dial to set the ratio from 0 to 255.</li> </ul>	
<b>PSK Font Color (Transmit)</b>		
<p>Set the text color for transmitted characters.</p> <ul style="list-style-type: none"> <li>• The color is set in RGB format.</li> <li>• The set color is indicated in the box beside the RGB scale.</li> </ul>	<ul style="list-style-type: none"> <li>• Push [◀ ▶] [F-3] to select R (Red), G (Green) and B (Blue), and then rotate the main dial to set the ratio from 0 to 255.</li> </ul>	
<b>PSK Font Color (Time Stamp)</b>		
<p>Set the text color for time stamp indication.</p> <ul style="list-style-type: none"> <li>• The color is set in RGB format.</li> <li>• The set color is indicated in the box beside the RGB scale.</li> </ul>	<ul style="list-style-type: none"> <li>• Push [◀ ▶] [F-3] to select R (Red), G (Green) and B (Blue), and then rotate the main dial to set the ratio from 0 to 255.</li> </ul>	
<b>PSK Font Color (TX Buffer)</b>		
<p>Set the text color in the TX buffer screen.</p> <ul style="list-style-type: none"> <li>• The color is set in RGB format.</li> <li>• The set color is indicated in the box beside the RGB scale.</li> </ul>	<ul style="list-style-type: none"> <li>• Push [◀ ▶] [F-3] to select R (Red), G (Green) and B (Blue), and then rotate the main dial to set the ratio from 0 to 255.</li> </ul>	

◇ Data saving

The USB flash drive is not supplied by Icom.

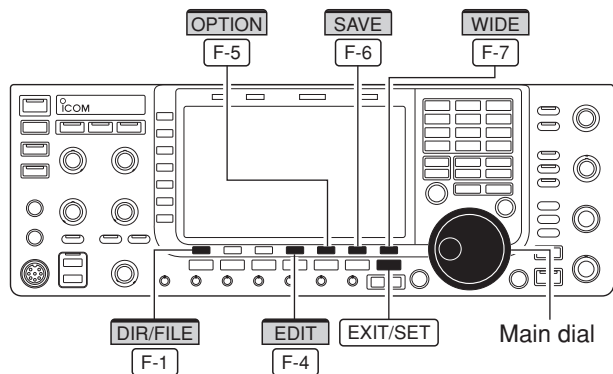

• Decode file save screen

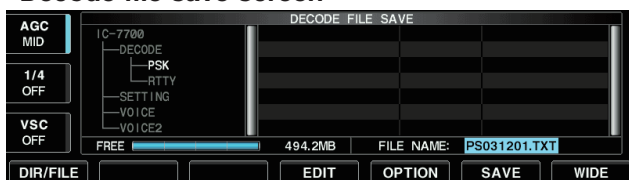

• Decode file save screen— file name edit

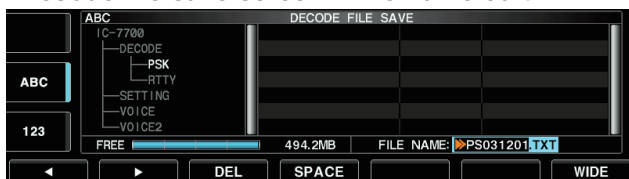

• Save option screen

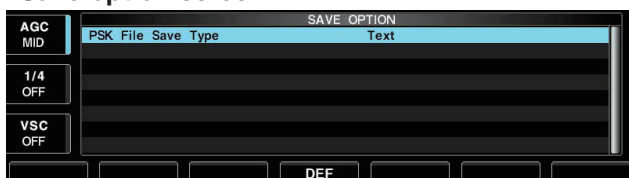

When a PC keyboard is connected to [USB] connector on the front panel, the file name can also be edited from the keyboard.

The contents of the PSK memory and received signal can be saved into the USB flash drive.

- ① During PSK decode screen display, push [**<MENU1>**] [F-1] to select PSK decode second menu.
- ② Push [**SAVE**] [F-6] to select decode file save screen.
- ③ Change the following conditions if desired.

• File name:

- ① Push [**EDIT**] [F-4] to select file name edit condition.
  - Push [**DIR/FILE**] [F-1] several times to select the file name, if necessary.
- ② Push [**ABC**] (MF6), [**123**] (MF7) or [**Symbol**] (MF7) to select the character group, then rotate the main dial to select the character.
  - [**ABC**] (MF6) : A to Z (capital letters); [**123**] (MF7): 0 to 9 (numerals); [**Symbol**] (MF7): ! # \$ % & ' ` ^ - ( ) { } \_ ~ @ can be selected.
  - Push [**<**] [F-1] to move the cursor left, push [**>**] [F-2] to move the cursor right, [**DEL**] [F-3] delete a character and push [**SPACE**] [F-4] to insert a space.
- ③ Push [**EXIT/SET**] to store the file name.

• File format

- ① Push [**OPTION**] [F-5] to enter save option screen.
- ② Rotate the main dial to select the saving format between Text and HTML.
  - “Text” is the default setting.
  - Hold down [**DEF**] [F-4] for 1 second to select the default setting.
- ③ Push [**EXIT/SET**] to return to the previous display.

• Saving location

- ① Push [**DIR/FILE**] [F-1] to select tree view screen.
- ② Select the desired directory or folder in the USB flash drive.
  - Push [**<>**] [F-4] to select the upper directory.
  - Push [**&u25b2**] [F-2] or [**&u25bc**] [F-3] to select folder in the same directory.
  - Hold down [**<>**] [F-4] for 1 second to select a folder in the directory.
  - Push [**REN/DEL**] [F-5] to rename the folder.
  - Hold down [**REN/DEL**] [F-5] for 1 second to delete the folder.
  - Hold down [**MAKE**] [F-6] for 1 second to make a new folder. (Edit the name with the same manner as the “• File name” above.)
- ③ Push [**DIR/FILE**] [F-1] twice to select the file name.

- ④ Push [**SAVE**] [F-6] .
  - After saving is completed, return to PSK decode second menu automatically.

✓ For your convenience!

Two data formats, Text and HTML, are available for PC data storage.



## ■ Operating AM

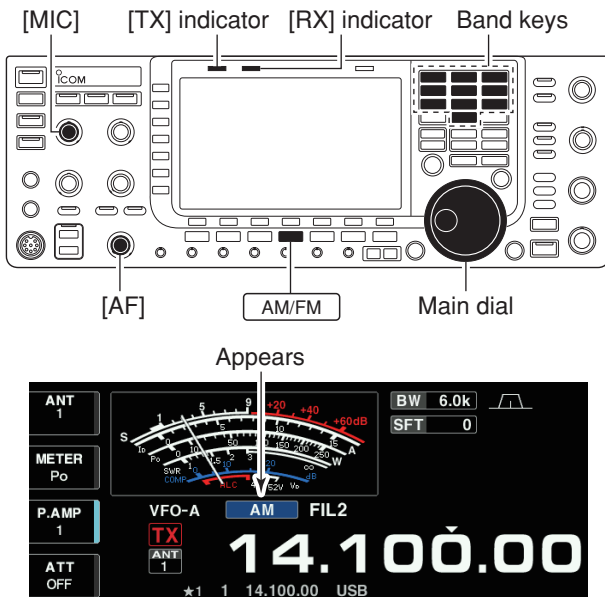

- ① Push a band key to select the desired band.
- ② Push **[AM/FM]** to select AM.
  - “AM” indicator appears.
  - After AM mode is selected, push **[AM/FM]** to toggle between AM and FM modes.
- ③ Rotate the main dial to tune to the desired frequency.
  - The S-meter indicates received signal strength when signal is received.
- ④ Rotate **[AF]** to set audio to a comfortable listening level.
- ⑤ Push **[TRANSMIT]** or **[PTT]** (microphone) to transmit.
  - The TX indicator lights red.
- ⑥ Speak into the microphone at your normal voice level.
  - Adjust the microphone gain with **[MIC]** at this step, if necessary.
- ⑦ Push **[TRANSMIT]** or release **[PTT]** (microphone) to return to receive.

## ◇ Convenient functions for receive

- **Preamp** (p. 5-10)
    - ➔ Push **[P.AMP]** (MF3) several times to set the preamp OFF, preamp 1 ON or preamp 2 ON.
      - Hold down **[P.AMP]** (MF3) for 1 second to turn the preamp function OFF.
      - “P.AMP1” or “P.AMP2” appears when the preamp 1 or preamp 2 is ON.
  - **Attenuator** (p. 5-10)
    - ➔ Push **[ATT]** (MF4) several times to set the attenuator in 6 dB steps.
      - Hold down **[ATT]** (MF3) for 1 second to turn the attenuator function OFF.
      - “ATT” and attenuation level appear when the attenuator is ON.
  - **Noise reduction** (p. 5-18)
    - ➔ Push **[NR]** to turn the noise reduction ON or OFF.
      - Rotate **[NR]** control to adjust the noise reduction level.
      - Noise reduction indicator (above **[NR]** switch) lights when the noise reduction is ON.
  - **Audio tone control** (p. 12-4)
    - ➔ Push **[SET]** **[F-7]** then **[LEVEL]** **[F-1]** to enter level set mode. Select an item with **[▲]** **[F-1]**/**[▼]** **[F-2]** then rotate the main dial to adjust the audio tone.
  - **Twin PBT (passband tuning)** (p. 5-13)
    - ➔ Rotate **[TWIN PBT]** controls (inner/outer).
      - PBT indicator (above **[PBT-CLR]** switch) lights when PBT is in use.
      - Hold down **[PBT-CLR]** for 1 second to clear the settings.
  - **Noise blanker** (p. 5-17)
    - ➔ Push **[NB]** to turn the noise blanker ON or OFF, and then rotate **[NB]** control to adjust the threshold level.
      - Noise blanker indicator (above **[NB]** switch) lights when the noise blanker is ON.
      - Hold down **[NB]** for 1 second to enter noise blanker set mode.
  - **Notch filter** (p. 5-19)
    - ➔ Push **[NOTCH]** to turn the manual notch function ON or OFF.
      - Rotate **[NOTCH]** control to set the attenuating frequency.
      - Notch indicator (above **[NOTCH]** switch) lights when either the auto or manual notch is ON.
  - **AGC (auto gain control)** (p. 5-12)
    - ➔ Push **[AGC]** switch several times to select AGC FAST, AGC MID or AGC SLOW.
      - ➔ Push **[AGC VR]** to turn the AGC time constant manual setting ON or OFF.
        - Rotate **[AGC]** control to adjust the time constant.
  - **Auto tuning function** (p. 5-22)
    - ➔ Push **[AUTOTUNE]** to turn the auto tuning function ON or OFF.
      - The transceiver automatically tunes the desired signal within  $\pm 5$  kHz range.
- IMPORTANT!**  
When receiving a weak signal, or receiving a signal with interference, the automatic tuning function may not tune, or may tune to an undesired signal.

◇ Convenient functions for transmit

• **VOX (voice operated transmit)** (p. 6-2)

- ➔ Push **VOX** to turn the VOX function ON or OFF.
  - “**VOX**” appears when the VOX function is ON.

• **Transmit quality monitor** (p. 6-4)

- ➔ Push **MONITOR** to turn the monitor function ON or OFF.
  - Rotate [MONI GAIN] to adjust the monitor gain.
  - Monitor indicator (above **MONITOR** switch) lights when the monitor function is ON.

• **Audio tone control** (p. 12-5)

- ➔ Push [SET] **F-7** then [LEVEL] **F-1** to enter level set mode. Select an item with [**▲**] **F-1**/[**▼**] **F-2** then rotate the main dial to adjust the audio tone.

## ■ Operating FM

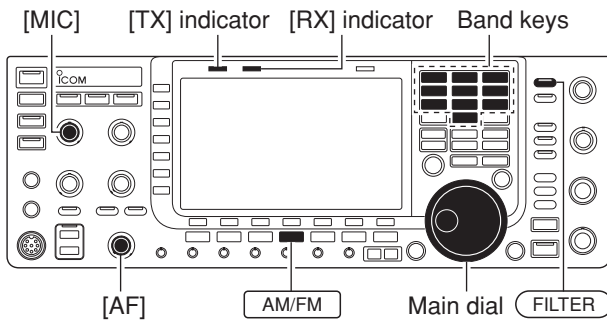

- ① Push a band key to select the desired band.
- ② Push **[AM/FM]** to select FM.
  - “FM” indicator appears.
  - After FM mode is selected, push **[AM/FM]** to toggle between FM and AM modes.
- ③ Rotate the main dial to tune to the desired frequency.
  - The S-meter indicates received signal strength when signal is received.
  - 10 kHz tuning step is preset for the FM mode.
  - Push **[FILTER]** several times to select the desired filter width.
- ④ Rotate **[AF]** to set audio to a comfortable listening level.
- ⑤ Push **[TRANSMIT]** or **[PTT]** (microphone) to transmit.
  - The TX indicator lights red.
- ⑥ Speak into the microphone at your normal voice level.
  - Adjust the microphone gain with **[MIC]** at this step, if necessary.
  - FM narrow transmission is available when “FIL2” or “FIL3” is selected.
- ⑦ Push **[TRANSMIT]** or release **[PTT]** (microphone) to return to receive.

### ◇ Convenient functions for receive

- **Preamp** (p. 5-10)
  - ➔ Push **[P.AMP]** (MF3) several times to set the preamp OFF, preamp 1 ON or preamp 2 ON.
    - Hold down **[P.AMP]** (MF3) for 1 second to turn the preamp function OFF.
    - “P.AMP1” or “P.AMP2” appears when the preamp 1 or preamp 2 is ON.
- **Auto notch filter** (p. 5-19)
  - ➔ Push **[NOTCH]** to turn the auto notch function ON or OFF.
    - Notch indicator (above **[NOTCH]** switch) lights when the auto notch is ON.
- **Attenuator** (p. 5-10)
  - ➔ Push **[ATT]** (MF4) several times to set the attenuator in 6 dB steps.
    - Hold down **[ATT]** (MF4) for 1 second to turn the attenuator function OFF.
    - “ATT” and attenuation level appear when the attenuator is ON.
- **Audio tone control** (p. 12-4)
  - ➔ Push **[SET]** **[F-7]** then **[LEVEL]** **[F-1]** to enter level set mode. Select an item with **[▲]** **[F-1]**/**[▼]** **[F-2]** then rotate the main dial to adjust the audio tone.

### ◇ Convenient functions for transmit

- **VOX (voice operated transmit)** (p. 6-2)
  - ➔ Push **[VOX]** to turn the VOX function ON or OFF.
    - “**VOX**” appears when the VOX function is ON.
- **Transmit quality monitor** (p. 6-4)
  - ➔ Push **[MONITOR]** to turn the monitor function ON or OFF.
    - Rotate **[MONI GAIN]** to adjust the monitor gain.
    - Monitor indicator (above **[MONITOR]** switch) lights when the monitor function is ON.
- **Audio tone control** (p. 12-5)
  - ➔ Push **[SET]** **[F-7]** then **[LEVEL]** **[F-1]** to enter level set mode. Select an item with **[▲]** **[F-1]**/**[▼]** **[F-2]** then rotate the main dial to adjust the audio tone.

## ■ Repeater operation

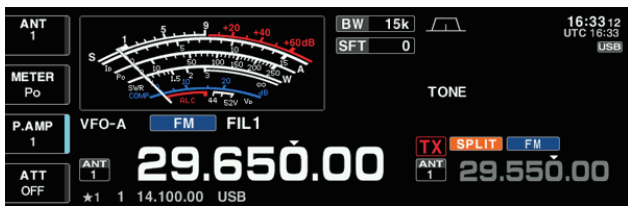
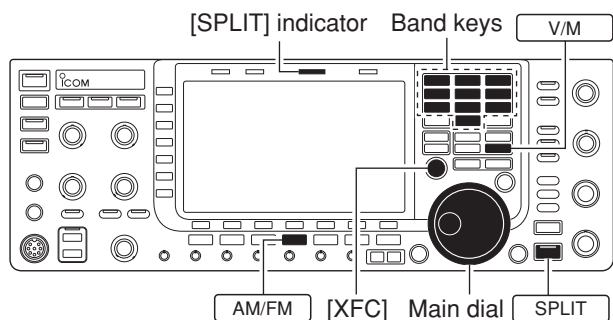

A repeater retransmits a received signal on a different frequency. When using a repeater, the transmit frequency is shifted from the receive frequency by an offset frequency. A repeater can be accessed using split frequency operation with the transmit frequency shifted to the repeater's receive frequency.

For accessing a repeater which requires an access tone, set the tone frequency in tone frequency set mode as described below.

- ① First, set the frequency offsets for HF and 50 MHz band, then turn ON the quick split function in Others set mode. (p. 12-13)
- ② Push **V/M** to select VFO mode.
- ③ Push the desired band key.
- ④ Push **AM/FM** several times to select FM mode.
- ⑤ Set the receive frequency (repeater output frequency).
- ⑥ Hold down **SPLIT** for 1 second to start repeater operation.
  - Repeater tone is turned ON automatically.
  - **[SPLIT]** indicator lights and "**SPLIT**" appears on the LCD.
  - Shifted transmit frequency and "TX" appear in the sub band.
  - The transmit frequency can be monitored while pushing **[XFC]**.
- ⑦ Hold down **[PTT]** to transmit; release **[PTT]** to receive.
- ⑧ To return to simplex, push **SPLIT** momentarily.

◇ Repeater access tone frequency setting

Some repeaters require subaudible tones to be accessed. Subaudible tones are superimposed on your normal signal and must be set in advance. The transceiver has 50 tones from 67.0 Hz to 254.1 Hz.

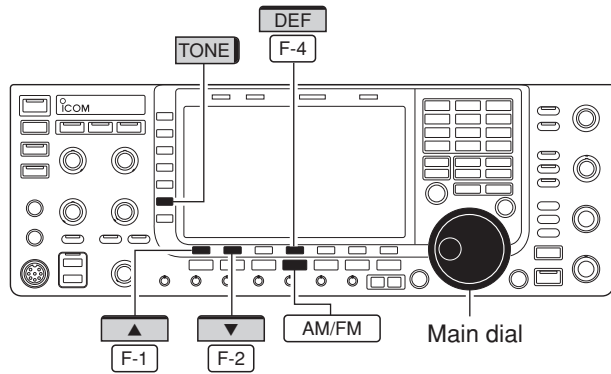

- ① Select FM mode.
- ② Hold down [TONE] (MF6) for 1 second to tone frequency set mode.
- ③ Push [▲] [F-1] or [▼] [F-2] to select REPEATER TONE item.
- ④ Rotate the main dial to select the desired repeater tone frequency.
  - Hold down [DEF] [F-4] for 1 second to select the default setting.
- ⑤ Push [EXIT/SET] to return to the previous display.

• Available tone frequencies (unit: Hz)

67.0	85.4	107.2	136.5	165.5	186.2	210.7	254.1
69.3	88.5	110.9	141.3	167.9	189.9	218.1	
71.9	91.5	114.8	146.2	171.3	192.8	225.7	
74.4	94.8	118.8	151.4	173.8	196.6	229.1	
77.0	97.4	123.0	156.7	177.3	199.5	233.6	
79.7	100.0	127.3	159.8	179.9	203.5	241.8	
82.5	103.5	131.8	162.2	183.5	206.5	250.3	

## ■ Tone squelch operation

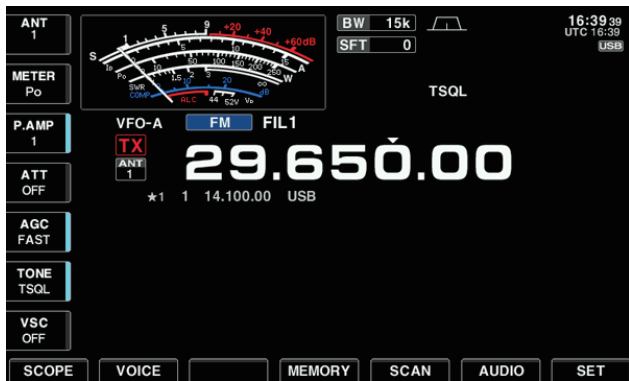
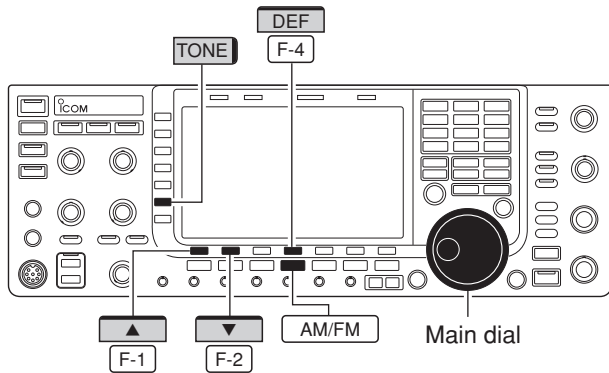

The tone squelch opens only when receiving a signal containing a matching subaudible tone. You can silently wait for calls from group members using the same tone.

- ① Set the desired frequency band and select FM mode.
- ② Push [TONE] (MF6) to turn the tone squelch function ON.
  - “TSQL” appears
- ③ Hold down [TONE] (MF6) for 1 second to select the tone frequency set mode.
- ④ Push [▲] [F-1] or [▼] [F-2] to select T-SQL TONE item.
- ⑤ Rotate the main dial to select the desired tone squelch frequency.
  - Hold down [DEF] [F-4] for 1 second to select the default setting.
- ⑥ Push [EXIT/SET] to return to the previous display.
- ⑦ When the received signal includes a matching tone, squelch opens and the signal can be heard.
  - When the received signal's tone does not match, tone squelch does not open. However, the S-indicator shows signal strength.
  - To open the squelch manually, push [XFC].
- ⑧ Operate the transceiver in the normal way.
- ⑨ To cancel the tone squelch, push [TONE] (MF6) to clear “TSQL.”

• Available tone frequencies (unit: Hz)

67.0	85.4	107.2	136.5	165.5	186.2	210.7	254.1
69.3	88.5	110.9	141.3	167.9	189.9	218.1	
71.9	91.5	114.8	146.2	171.3	192.8	225.7	
74.4	94.8	118.8	151.4	173.8	196.6	229.1	
77.0	97.4	123.0	156.7	177.3	199.5	233.6	
79.7	100.0	127.3	159.8	179.9	203.5	241.8	
82.5	103.5	131.8	162.2	183.5	206.5	250.3	

## ■ Data mode (AFSK) operation

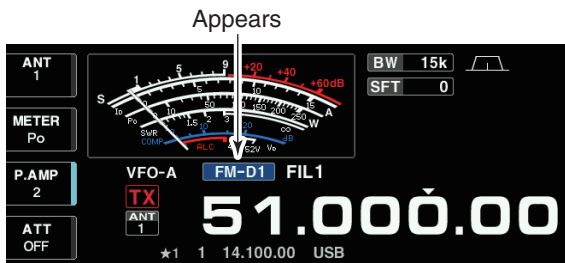
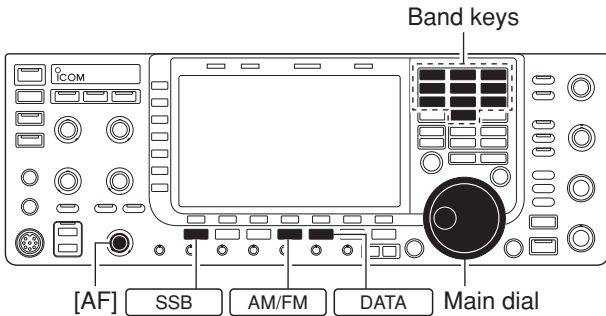

When operating RTTY, SSTV, AMTOR or PACKET with your TNC and/or PC software in the AFSK mode, consult the manual that comes with the TNC and/or the software.

- ① Connect a PC and TNC to the transceiver. (p. 2-9)
- ② Push a band key to select the desired band.
- ③ Push **[SSB]** or **[AM/FM]** to select the desired operating mode.
- ④ Push **[DATA]** to turn data mode ON.
  - One of “-D1,” “-D2” or “-D3” is additionally appears.
  - During data mode selection, hold down **[DATA]** for 1 second to select data mode 1 (D1), 2 (D2) and 3 (D3) in sequence.
- ⑤ Rotate the main dial to tune to the desired signal and decode it correctly.
  - Also use the tuning indicator of the TNC or software.
  - During SSB data mode, the 1/4 tuning function can be used for critical tuning.
- ⑥ Operate the PC (software) or TNC to transmit.
  - When operating in SSB data mode, adjust the TNC output level so that the ALC meter reading doesn't go outside the ALC zone.

**NOTE:** When data mode 1 (D1) is selected, the audio input from the [ACC1 (pin 4)] is used for transmission instead of [MIC]'s. (Modulation input connector can be changed in ACC set mode (pp. 12-7, 12-8). DATA1: [ACC], DATA2: [MIC] and [ACC], DATA3: [MIC] are default settings. )

The fixed condition is used for SSB data transmission as follows:

- [COMP] : OFF
- Tx bandwidth : MID
- Tx Tone (Bass) : 0
- Tx Tone (Treble) : 0

### • Mark and Space tones of RTTY in the AFSK mode operating in the LSB mode

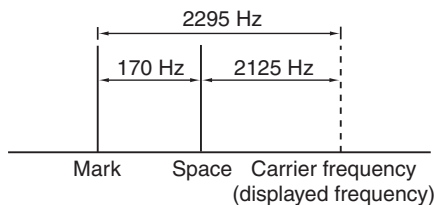

### ✓ For your information

Carrier frequency is displayed when SSB data mode is selected.

See the diagram to the left for the tone-pair example.





■ Spectrum scope screen .....	5-2
◇ Center mode .....	5-2
◇ Fixed mode .....	5-3
◇ Mini scope screen display .....	5-4
◇ Scope set mode .....	5-4
◇ USB mouse operation .....	5-9
■ Preamplifier .....	5-10
■ Attenuator .....	5-10
■ RIT function .....	5-11
◇ RIT monitor function .....	5-11
■ AGC function .....	5-12
◇ Selecting the preset value .....	5-12
◇ Adjusting the AGC time constant .....	5-12
◇ Setting the AGC time constant preset value .....	5-12
■ Twin PBT operation .....	5-13
■ IF filter selection .....	5-14
◇ IF filter selection .....	5-14
◇ Filter passband width setting (except FM mode) .....	5-14
◇ Roofing filter selection .....	5-15
◇ DSP filter shape .....	5-15
◇ Filter shape set mode .....	5-15
■ Noise blanker .....	5-17
◇ NB set mode .....	5-17
■ Noise reduction .....	5-18
■ Dial lock function .....	5-18
■ Notch function .....	5-19
■ Digital selector .....	5-19
■ Audio Scope screen .....	5-20
◇ Audio scope set mode .....	5-21
■ Autotune function .....	5-22

## ■ Spectrum scope screen

### ◇ Center mode

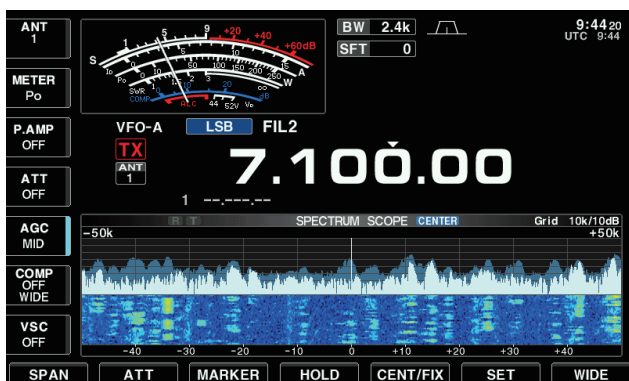
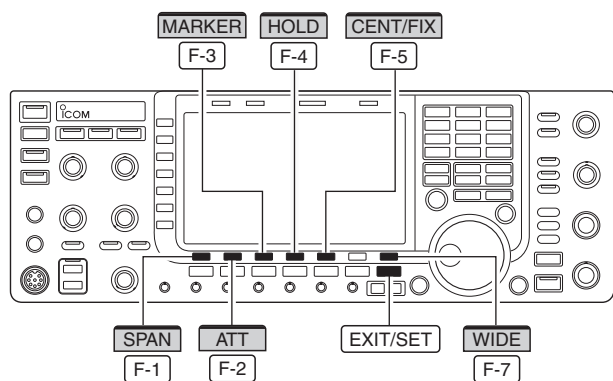

### • Spectrum scope

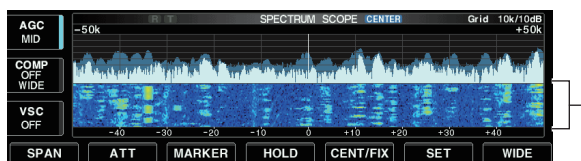

Waterfall

### • Scope spurious signal example

Spurious signals may be received on the spectrum scope screen regardless of the transceiver's state (TX or RX). They are generated in the scope circuit. This does not indicate a transceiver malfunction.

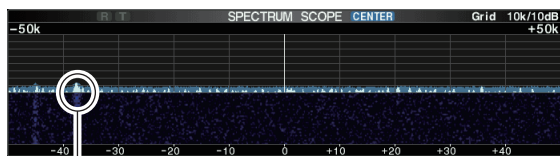

Scope spurious example

This DSP-based spectrum scope allows you to display the frequency and relative signal strength of received signals on the strengths of signals. The IC-7700 has two modes for the spectrum display—one is center mode, and the other is fixed mode.

In addition, the IC-7700 has a mini scope screen to save screen space.

Displays signals around the set frequency within the selected span. The set frequency is always displayed at the center of the screen.

- ① Push [EXIT/SET] several times to close any multi-function screens, if necessary.
- ② Push [SCOPE] [F-1] to select the scope screen.
  - Push [WIDE] [F-7] to toggle the screen size between normal and wide.
- ③ Push [CENT/FIX] [F-5] to select the center mode.
  - “CENTER” is displayed when center mode is selected.
- ④ Push [SPAN] [F-1] several times to select the scope span.
  - ±2.5, ±5.0, ±10, ±25, ±50, ±100 and ±250 kHz are selectable.
  - Hold down [SPAN] [F-1] for 1 second to return to ±2.5 kHz span.
  - Sweep speed is selectable for each span independently in scope set mode. (pp. 5-5, 5-6)
- ⑤ Push [ATT] [F-2] several times to activate an attenuator or turn the attenuator OFF.
  - 10, 20 and 30 dB of attenuation is available.
  - Hold down [ATT] [F-2] for 1 second to turn OFF the attenuator.
- ⑥ Push [MARKER] [F-3] to turn the marker for transmit frequency ON or OFF.
  - “T” displays the marker at the transmit frequency.
  - “<<” or “>>” appears when the marker is out of range.
  - The spectrum scope shows the transmit signal while transmitting. This can be deactivated in scope set mode. (p. 5-5)
  - The spectrum scope shows the peak level hold function. Peak levels are displayed in the background of the current spectrum in a different color until the receive frequency changes. This can be deactivated and the waveform color can be set in scope set mode. (p. 5-5)
- ⑦ Push [HOLD] [F-4] to freeze the current spectrum display.
  - “HOLD” appears while the function is in use.
  - The peak hold function can be deactivated in scope set mode.
- ⑧ Push [EXIT/SET] to exit the scope screen.

**NOTE:** If a strong signal is received, a ghost signal may also appear. Push [ATT] [F-2] several times to activate the spectrum scope attenuator in this case. Spurious signals may be displayed. They are generated in the internal scope circuit and do not indicate a transceiver malfunction.

## ◇ Fixed mode

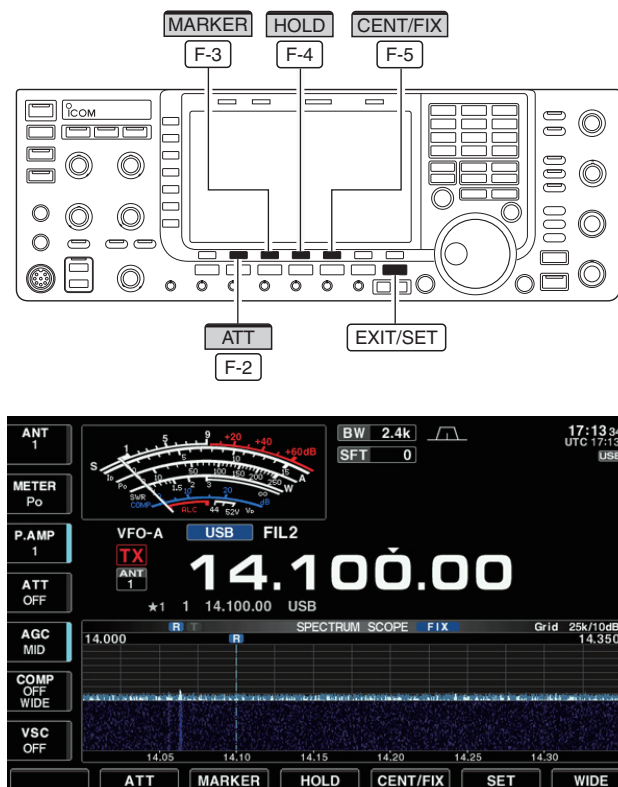

Displays signals within the specified frequency range. Conditions on the selected frequency band can be observed at a glance when using this mode.

- ① Push [EXIT/SET] several times to close any multi-function screens, if necessary.
- ② Push [SCOPE] [F-1] to select the scope screen.
  - Push [WIDE] [F-7] to toggle the screen size between normal and wide.
- ③ Push [CENT/FIX] [F-5] to select the fixed mode.
  - “FIX” is displayed when fixed mode is selected.
- ④ Push [ATT] [F-2] several times to activate an attenuator or turn the attenuator OFF.
  - 10, 20 and 30 dB of attenuation is selectable.
  - Hold down [ATT] [F-2] for 1 second to turn OFF the attenuator.
- ⑤ Push [MARKER] [F-3] several times to select the marker for transmit frequency or turn the marker OFF.
  - “R” displays the marker at the receive frequency. (always displayed)
  - “T” displays the marker at the transmit frequency.
  - “<<” or “>>” appears when the marker is out of range.
  - The spectrum scope shows the transmit signal while transmitting. This can be deactivated in scope set mode. (p. 5-5)
  - The spectrum scope shows the peak level hold function. Peak levels are displayed in the background of the current spectrum in a different color until the receive frequency changes. This can be deactivated and the waveform color can be set in scope set mode. (p. 5-5)
- ⑥ Push [HOLD] [F-4] to freeze the current spectrum waveform.
  - “HOLD” appears while the function is in use.
  - The peak hold function can be deactivated in scope set mode.
- ⑦ Push [EXIT/SET] to exit the scope screen.

NOTE: If a strong signal is received, a ghost signal may appear. Push [ATT] [F-2] several times to activate the spectrum scope attenuator in this case.

The scope bandwidth can be specified for each frequency band independently in scope set mode. (pp. 5-6 to 5-8)

## 5 FUNCTIONS FOR RECEIVE

### ◇ Mini scope screen display

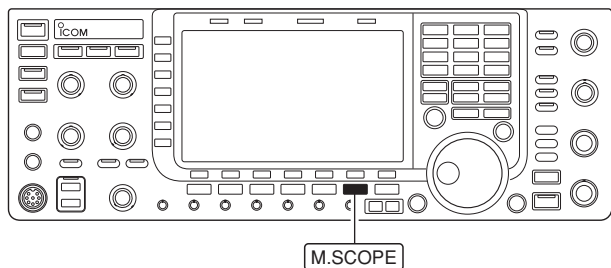

The mini scope screen can be displayed with another screen display, such as set mode menu, decode screen, memory list screen, etc. simultaneously.

- ① Set the scope mode (center or fixed), marker, attenuator, span, etc. in advance. (pp. 5-2, 5-3)
- ② Push **M.SCOPE** to toggle the mini scope display ON or OFF.
  - The S/R/F meter type during mini scope display can be selected in display set mode (Meter Type (Wide Screen) item). (p. 12-10)

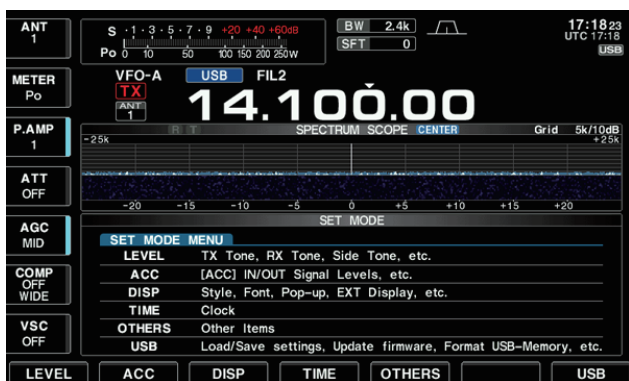

### ◇ Scope set mode

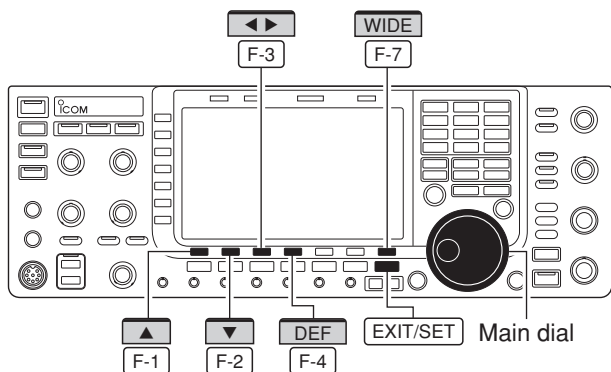





This set mode is used to set the waveform color, sweeping speed, scope range for fixed mode, etc.

- ① During spectrum scope display ON, push **[SET] F-6** to select scope set mode screen.
  - Push **[WIDE] F-7** to toggle the screen size between normal and wide.
- ② Push **[▲] F-1** or **[▼] F-2** to select the desired set item.
- ③ Set the desired condition using the main dial.
  - Hold down **[DEF] F-4** for 1 second to select the default condition or value.
  - Push **[◀▶] F-3** to select the set contents for some items.
- ④ Push **[EXIT/SET]** to exit from set mode.



## ◇ Scope set mode (continued)

<b>Scope during Tx (CENTER Type)</b> <b>ON</b>	
Turn display of the transmit signal ON or OFF.	 <b>NOTE:</b> Transmit signal display is available for the center mode only.
<b>Max Hold</b> <b>ON</b>	
Turn the peak level hold function ON or OFF.	
<b>CENTER Type Display</b> <b>Filter Center</b>	
Select the center frequency of the spectrum scope display (center mode only).	<ul style="list-style-type: none"> <li>• Filter Center : Shows the selected filter's center frequency at the center.</li> <li>• Carrier Point Center : Shows the selected operating mode carrier point frequency at the center.</li> <li>• Carrier Point Center (Abs. Freq.) : In addition to the carrier point center setting above, the actual frequency is displayed at the bottom of the scope.</li> </ul>
<b>Waveform Type</b> <b>Fill</b>	
Select the outline indication of the waveform for the spectrum scope.	<ul style="list-style-type: none"> <li>• Fill : The waveform is described by only the color.</li> <li>• Fill + Line : The waveform is described by the color and outline.</li> </ul>
<b>Waveform Color (Current)</b> 	
Set the waveform color for the currently received signals.	<ul style="list-style-type: none"> <li>• The color is set in RGB format.</li> <li>• Push [◀ ▶] [F-3] to select R (Red), G (Green) and B (Blue), and rotate the ratio from 0 to 255 range.</li> <li>• The set color is indicated in the box beside the RGB scale.</li> </ul>
<b>Waveform Color (Line)</b> 	
Set the waveform color for the currently received signals.	<ul style="list-style-type: none"> <li>• The color is set in RGB format.</li> <li>• Push [F-3] [◀ ▶] to select R (Red), G (Green) and B (Blue), and rotate the ratio from 0 to 255 range.</li> <li>• The set color is indicated in the box beside the RGB scale.</li> </ul>
<b>Waveform Color (Max Hold)</b> 	
Set the waveform color for the received signals maximum level.	<ul style="list-style-type: none"> <li>• The color is set in RGB format.</li> <li>• Push [◀ ▶] [F-3] to select R (Red), G (Green) and B (Blue), and rotate the ratio from 0 to 255 range.</li> <li>• The set color is indicated in the box beside the RGB scale.</li> </ul>

◇ Scope set mode (continued)

<b>Waterfall Display</b>	<b>ON</b>
Set the waterfall display to ON or OFF.	<ul style="list-style-type: none"> <li>• ON : Displays the waterfall of the spectrum scope.</li> <li>• OFF : Does not display the waterfall.</li> </ul>
<b>Waterfall Peak Color Level</b>	<b>Grid 8</b>
<p>The signal level that reaches a peak color is set to Grid 1 to Grid 8 for the waterfall display.</p> <p>Higher signal levels are Red, Yellow, Green, Light-blue, Blue and Black in order.</p>	
<b>Sweep Speed (± 2.5k)</b>	<b>MID</b>
Select the sweep speed for the ±2.5 kHz span selection from SLOW, MID and FAST.	<p>▨ <b>NOTE:</b> Signals may be displayed incorrectly with "FAST" setting.</p>
<b>(± 5k)</b>	<b>MID</b>
Select the sweep speed for the ±5 kHz span selection from SLOW, MID and FAST.	<p>▨ <b>NOTE:</b> Signals may be displayed incorrectly with "FAST" setting.</p>
<b>(± 10k)</b>	<b>FAST</b>
Select the sweep speed for the ±10 kHz span selection from SLOW, MID and FAST.	
<b>(± 25k)</b>	<b>FAST</b>
Select the sweep speed for the ±25 kHz span selection from SLOW, MID and FAST.	
<b>(± 50k)</b>	<b>FAST</b>
Select the sweep speed for the ±50 kHz span selection from SLOW, MID and FAST.	
<b>(± 100k)</b>	<b>FAST</b>
Select the sweep speed for the ±100 kHz span selection from SLOW, MID and FAST.	
<b>(± 250k)</b>	<b>FAST</b>
Select the sweep speed for the ±250 kHz span selection from SLOW, MID and FAST.	

## ◇ Scope set mode (continued)

<b>Fixed Edges ( 0.03 – 1.60)</b>	<b>0.750 – 1.250 MHz</b>
Set the scope edge frequencies for fixed mode for bands below 1.6 MHz.	<ul style="list-style-type: none"> <li>Set the frequencies within 0.030 to 1.600 MHz range in 1 kHz steps.</li> <li>As edge frequencies are set, the other edge frequency will be automatically set for a display band width of 5 kHz to a maximum of 500 kHz.</li> </ul>
<b>( 1.60 – 2.00)</b>	<b>1.800 – 2.000 MHz</b>
Set the scope edge frequencies for fixed mode scope when the 1.6 to 2 MHz band is selected.	<ul style="list-style-type: none"> <li>Set the frequencies within 1.600 to 2.000 MHz range in 1 kHz steps.</li> </ul>
<b>( 2.00 – 6.00)</b>	<b>3.500 – 4.000 MHz</b>
Set the scope edge frequencies for fixed mode scope when the 2 to 6 MHz band is selected.	<ul style="list-style-type: none"> <li>Set the frequencies within 2.000 to 6.000 MHz range in 1 kHz steps.</li> <li>As edge frequencies are set, the other edge frequency will be automatically set for a display band width of 5 kHz to a maximum of 500 kHz.</li> </ul>
<b>( 6.00 – 8.00)</b>	<b>7.000 – 7.300 MHz</b>
Set the scope edge frequencies for fixed mode scope when the 6 to 8 MHz band is selected.	<ul style="list-style-type: none"> <li>Set the frequencies within 6.000 to 8.000 MHz range in 1 kHz steps.</li> <li>As edge frequencies are set, the other edge frequency will be automatically set for a display band width of 5 kHz to a maximum of 500 kHz.</li> </ul>
<b>( 8.00 – 11.00)</b>	<b>10.100 – 10.150 MHz</b>
Set the scope edge frequencies for fixed mode scope when the 8 to 11 MHz band is selected.	<ul style="list-style-type: none"> <li>Set the frequencies within 8.000 to 11.000 MHz range in 1 kHz steps.</li> <li>As edge frequencies are set, the other edge frequency will be automatically set for a display band width of 5 kHz to a maximum of 500 kHz.</li> </ul>
<b>(11.00 – 15.00)</b>	<b>14.000 – 14.350 MHz</b>
Set the scope edge frequencies for fixed mode scope when the 11 to 15 MHz band is selected.	<ul style="list-style-type: none"> <li>Set the frequencies within 11.000 to 15.000 MHz range in 1 kHz steps.</li> <li>As edge frequencies are set, the other edge frequency will be automatically set for a display band width of 5 kHz to a maximum of 500 kHz.</li> </ul>
<b>(15.00 – 20.00)</b>	<b>18.068 – 18.168 MHz</b>
Set the scope edge frequencies for fixed mode scope when the 15 to 20 MHz band is selected.	<ul style="list-style-type: none"> <li>Set the frequencies within 15.000 to 20.000 MHz range in 1 kHz steps.</li> <li>As edge frequencies are set, the other edge frequency will be automatically set for a display band width of 5 kHz to a maximum of 500 kHz.</li> </ul>

◇ Scope set mode (continued)

<b>(20.00 – 22.00)</b>	<b>21.000 – 21.450 MHz</b>
Set the scope edge frequencies for fixed mode scope when the 20 to 22 MHz band is selected.	<ul style="list-style-type: none"> <li>• Set the frequencies within 20.000 to 22.000 MHz range in 1 kHz steps.</li> <li>▨ As edge frequencies are set, the other edge frequency will be automatically set for a display band width of 5 kHz to a maximum of 500 kHz.</li> </ul>
<b>(22.00 – 26.00)</b>	<b>24.890 – 24.990 MHz</b>
Set the scope edge frequencies for fixed mode scope when the 22 to 26 MHz band is selected.	<ul style="list-style-type: none"> <li>• Set the frequencies within 22.000 to 26.000 MHz range in 1 kHz steps.</li> <li>▨ As edge frequencies are set, the other edge frequency will be automatically set for a display band width of 5 kHz to a maximum of 500 kHz.</li> </ul>
<b>(26.00 – 30.00)</b>	<b>28.000 – 28.500 MHz</b>
Set the scope edge frequencies for fixed mode scope when the 26 to 30 MHz band is selected.	<ul style="list-style-type: none"> <li>• Set the frequencies within 26.000 to 30.000 MHz range in 1 kHz steps.</li> <li>▨ As edge frequencies are set, the other edge frequency will be automatically set for a display band width of 5 kHz to a maximum of 500 kHz.</li> </ul>
<b>(30.00 – 45.00)</b>	<b>30.000 – 30.500 MHz</b>
Set the scope edge frequencies for fixed mode scope when the 30 to 45 MHz band is selected.	<ul style="list-style-type: none"> <li>• Set the frequencies within 30.000 to 45.000 MHz range in 1 kHz steps.</li> <li>▨ As edge frequencies are set, the other edge frequency will be automatically set for a display band width of 5 kHz to a maximum of 500 kHz.</li> </ul>
<b>(45.00 – 60.00)</b>	<b>50.000 – 50.500 MHz</b>
Set the scope edge frequencies for fixed mode scope when the 45 to 60 MHz band is selected.	<ul style="list-style-type: none"> <li>• Set the frequencies within 45.000 to 60.000 MHz range in 1 kHz steps.</li> <li>▨ As edge frequencies are set, the other edge frequency will be automatically set for a display band width of 5 kHz to a maximum of 500 kHz.</li> </ul>



◇ USB mouse operation

If you connect a USB mouse to the transceiver, a mouse pointer appears on the spectrum scope screen. Now, you can change the frequency by using the mouse.

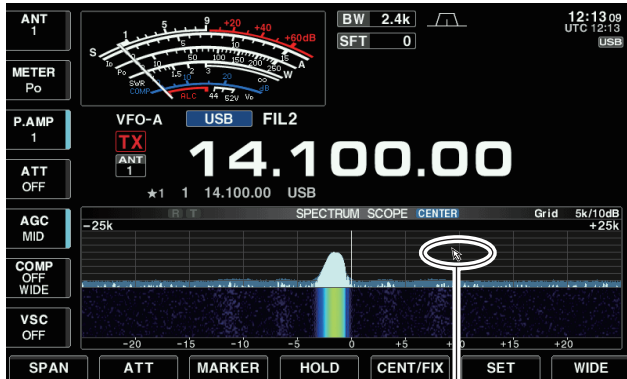

Mouse pointer

While holding down [XFC], the mouse changes the transmit frequency.

• Mouse operation on the Center mode

Button	Operation	Description
Left	Click	The frequency changes to the clicking point and mouse pointer move to the center of the screen.
	Drag	The frequency changes to the clicking point and mouse pointer move to the center of the screen, and then the frequency increases or decreases.
Right	Click/Drag	The Right button temporarily changes the frequency. While holding the button, same action as the Left button, but release it to return to the original frequency.

• Mouse operation on the Fix mode

Button	Operation	Description
Left	Click	The frequency and marker change to the clicking point.
	Drag	The frequency and marker change to the clicking point, and then the frequency increases or decreases.
Right	Click/Drag	The Right button temporarily changes the frequency. While holding the button, same action as the Left button, but release it to return to the original frequency.

Changing frequencies in the Drag operation differ depending on the tuning step settings.

## ■ Preamplifier

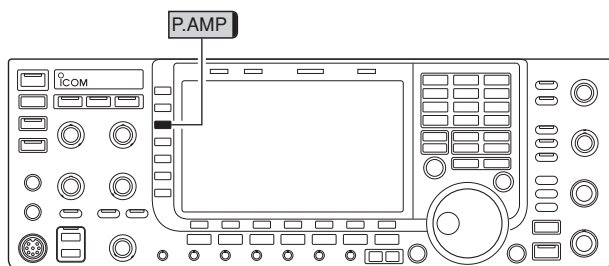

The preamp (P.AMP1 or P.AMP2) cannot be used while the digital selector is activated. Also the preamp is automatically disabled when the digital selector is turned ON.

The preamp amplifies received signals in the receiver front end, to improve the S/N ratio and sensitivity. Set this to preamp 1 or preamp 2 when receiving weak signals.

- Push [P.AMP] (MF3) several times to set the preamp OFF, preamp 1 ON or preamp 2 ON.
- Hold down [P.AMP] (MF3) for 1 second to turn the preamp function OFF.

**P.AMP 1** For all HF and 50 MHz bands

**P.AMP 2** High-gain preamp for 24 MHz band and above (Available for all HF and 50 MHz bands)

### ✓ About the “P.AMP2”

The “P.AMP 2” is a high gain receive amplifier. When the “P.AMP 2” is used in the presence of strong electromagnetic fields, distortion sometimes results. In such cases, use the transceiver with the “P.AMP 1” or “P.AMP OFF” setting.

The “P.AMP 2” is most effective when:

- Used on bands above 24 MHz and when signals are weak.
- Receive sensitivity is insufficient when using low-gain antennas, or while using a narrow band antenna (such as small loop, a Beverage antenna or a short Yagi antenna).

## ■ Attenuator

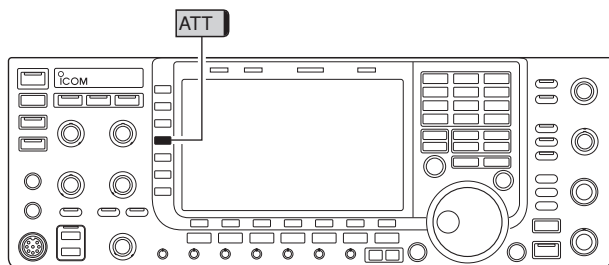

The attenuator prevents a desired signal from being distorted when very strong signals are near the desired frequency or when very strong electromagnetic fields, such as from broadcast stations near your location.

- Push [ATT] (MF4) several times to set the attenuator 6 dB, 12 dB, 18 dB or attenuator OFF.
- Hold down [ATT] (MF4) for 1 second to turn the attenuator function OFF.

**ATT 6dB** 6 dB attenuation

**ATT 12dB** 12 dB attenuation

**ATT 18dB** 18 dB attenuation

## ■ RIT function

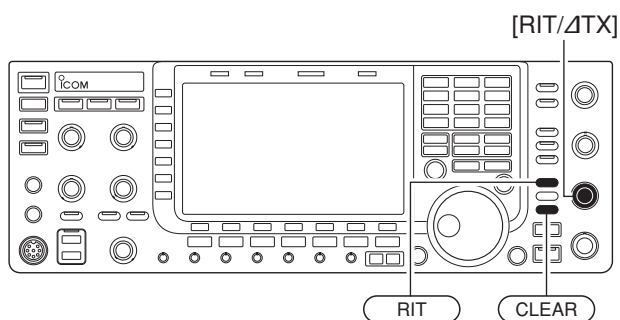

The RIT (Receive Increment Tuning) function compensates for off-frequency operation of the received station.

The function shifts the receive frequency up to  $\pm 9.99$  kHz in 10 Hz steps without moving the transmit frequency.

- ① Push **RIT** to turn the RIT function ON and OFF.
  - “**RIT**” and the tuned receive frequency appear when the function is ON.
- ② Rotate the **[RIT/ΔTX]** control.
  - Hold down **CLEAR** for 1 second to reset the RIT frequency.
  - Push **CLEAR** momentarily to reset the RIT frequency when the quick RIT/ΔTX clear function is ON. (p. 12-15)
  - Hold down **RIT** for 1 second to add the shift frequency to the operating frequency.

## ◇ RIT monitor function

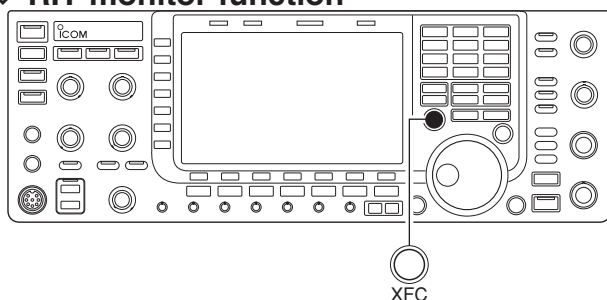

When the RIT function is ON, holding down [XFC] allows you to monitor the operating frequency directly (RIT is temporarily cancelled).

---

### ✓ For your convenience — Calculate function

The shift frequency of the RIT function can be added/subtracted to the displayed frequency.

- ➔ While displaying the RIT shift frequency, hold down **RIT** for 1 second.
-

## AGC function

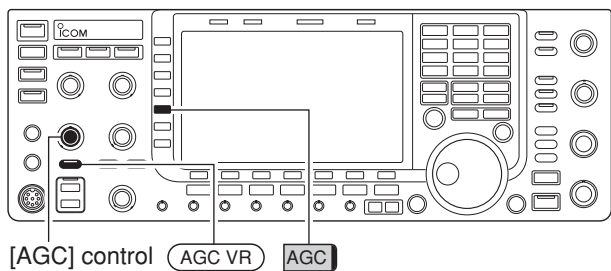

The AGC (auto gain control) controls receiver gain to produce a constant audio output level even when the received signal strength varies greatly.

The transceiver has 3 preset AGC characteristics (time constant: fast, mid, slow) for non-FM modes.

The FM mode AGC time constant is fixed as 'FAST' (0.1 seconds) and AGC time constant cannot be changed.

### Selecting the preset value

- ① Select any non-FM mode.
- ② Push [AGC] (MF5) several times to select AGC fast, AGC medium (MID) or AGC slow.
  - Hold down [AGC VR] for 1 second to turn the AGC function OFF.

### Adjusting the AGC time constant

- ① Select any non-FM mode.
- ② Push [AGC VR], then rotate [AGC] control to adjust the AGC time constant.
  - [AGC VR] indicator above the switch lights green.

### Setting the AGC time constant preset value

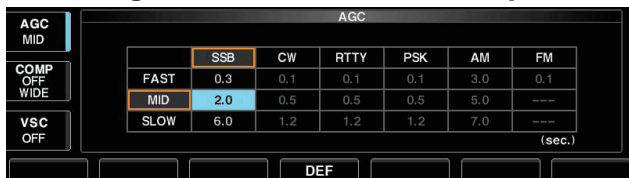

- ① Select any non-FM mode.
- ② Hold down [AGC] (MF5) for 1 second to enter AGC set mode.
- ③ Push [AGC] (MF5) several times to select FAST time constant.
- ④ Rotate the main dial to set the desired time constant for 'AGC FAST.'
  - AGC time constant can be set between 0.1 to 8.0 seconds (depends on mode) or turned OFF.
  - Hold down [DEF] [F-4] for 1 second to select a default value.
- ⑤ Push [AGC] (MF5) to select medium time constant.
- ⑥ Rotate the main dial to set the desired time constant for 'AGC MID.'
  - AGC time constant can be set between 0.1 to 8.0 seconds (depends on mode) or turned OFF.
  - Hold down [DEF] [F-4] for 1 second to select a default value.
- ⑦ Push [AGC] (MF5) to select slow time constant.
- ⑧ Rotate the main dial to set the desired time constant for 'AGC SLOW.'
  - AGC time constant can be set between 0.1 to 8.0 seconds (depends on mode) or turned OFF.
  - Hold down [DEF] [F-4] for 1 second to select a default value.
- ⑨ Select another non-FM mode. Repeat steps ③ to ⑧ if desired.
- ⑩ Push [EXIT/SET] to exit the AGC set mode screen.

### Selectable AGC time constant (unit: sec.)

Mode	Default	Selectable AGC time constant
SSB	0.3 (FAST)	0.1, 0.2, 0.3, 0.5, 0.8, 1.2, 1.6, 2.0, 2.5, 3.0, 4.0, 5.0, 6.0
	2.0 (MID)	
	6.0 (SLOW)	
CW	0.1 (FAST)	0.1, 0.2, 0.3, 0.5, 0.8, 1.2, 1.6, 2.0, 2.5, 3.0, 4.0, 5.0, 6.0
	0.5 (MID)	
	1.2 (SLOW)	
RTTY PSK	0.1 (FAST)	0.1, 0.2, 0.3, 0.5, 0.8, 1.2, 1.6, 2.0, 2.5, 3.0, 4.0, 5.0, 6.0
	0.5 (MID)	
	1.2 (SLOW)	
AM	3.0 (FAST)	0.3, 0.5, 0.8, 1.2, 1.6, 2.0, 2.5, 3.0, 4.0, 5.0, 6.0, 7.0, 8.0
	5.0 (MID)	
	7.0 (SLOW)	
FM	0.1 (FAST)	Fixed

## ■ Twin PBT operation

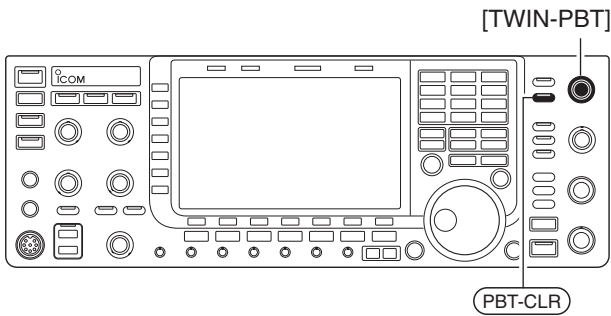

Shows passband width, shift value and condition

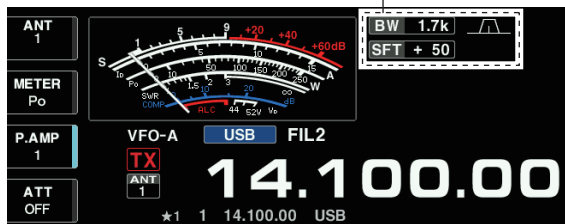

### • Filter set screen



### • About passband width and shift value on the screen

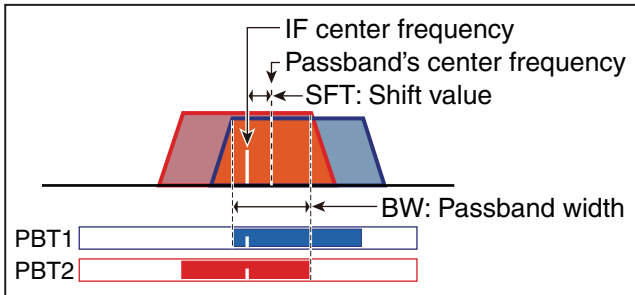

### • PBT operation example

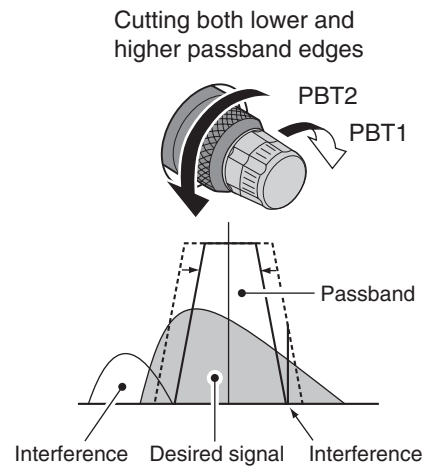
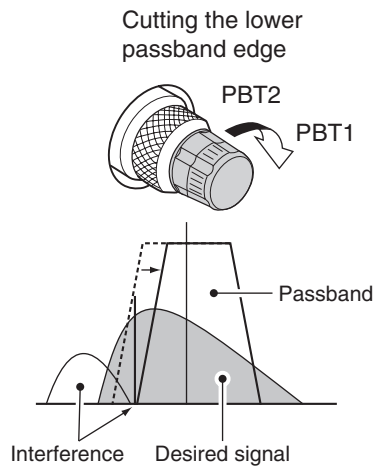
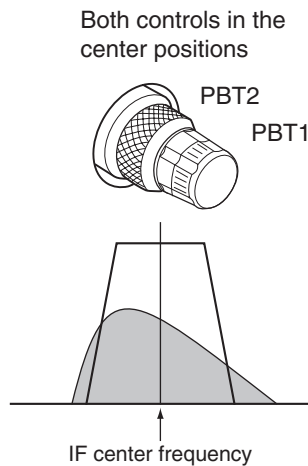

To reject interference, PBT (Passband Tuning) electronically narrows the IF passband width by shifting the IF frequency slightly outside of the IF filter passband. The IC-7700 uses DSP for the PBT function. Moving both [TWIN-PBT] controls shifts the IF passband center frequency both above and below the received frequency.

- The LCD graphically shows the passband width and shift frequency.
  - PBT indicator above [PBT-CLR] switch lights when PBT is in use.
- Hold down [FILTER] for 1 second to enter the filter set screen. Current passband width and shift frequency is displayed in the filter set screen.
- Hold down [PBT-CLR] for 1 second to set the [TWIN-PBT] controls to the center positions.

The PBT is adjustable in 50 Hz steps in the SSB/CW/RTTY/PSK modes, and 200 Hz in the AM mode. In this time, the shift value changes in 25 Hz steps in the SSB/CW/RTTY/PSK modes, and 100 Hz in the AM mode.

- [TWIN-PBT] should normally be set to the center positions (PBT setting is cleared) when there is no interference.
- When PBT is used, the audio tone may be changed.
- Not available for FM mode.
- While rotating [TWIN-PBT], noise may occur. This comes from the DSP unit and does not indicate an equipment malfunction.

## IF filter selection

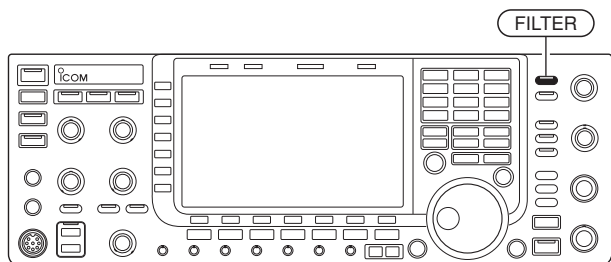

- ▨ The filter selection is automatically memorized in each mode.
- ▨ The PBT shift frequencies are automatically memorized in each filter.

### ◇ IF filter selection

The transceiver has 3 passband width IF filters for each mode.

For SSB, CW and PSK modes, the passband width can be set within 50 to 3600 Hz in 50 or 100 Hz steps. A total of 41 passband widths are available.

For RTTY mode, the passband width can be set within 50 to 2700 Hz in 50 or 100 Hz steps. A total of 32 passband widths are available.

For AM mode, the passband width can be set within 200 Hz to 10 kHz in 200 Hz steps. A total of 50 passband widths are available.

For FM mode, the passband width is fixed and 3 passband widths are available.

- ① Select the desired mode.
- ② Push **[FILTER]** several times to select the IF filter 1, 2 or 3.
  - The selected passband width and filter number is displayed in the LCD.

### ◇ Filter passband width setting (except FM mode)



- During the passband width setting

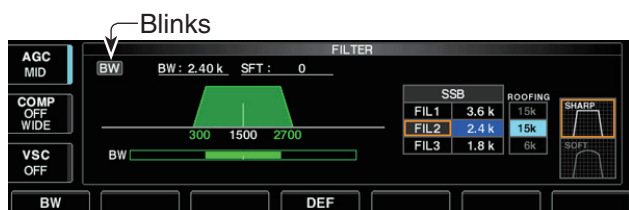

- ① Hold down **[FILTER]** for 1 second to enter filter set screen.
- ② Select any mode except FM.
  - Passband widths for FM modes are fixed and cannot be adjusted.
- ③ Push **[FILTER]** several times to select the desired IF filter.
- ④ Push **[BW] [F-1]**, then rotate the main dial to set the desired passband width. Then push **[BW] [F-1]** again.
  - Hold down **[DEF] [F-4]** for 1 second to select the default value.
  - While holding down **[BW] [F-1]**, rotating the main dial also adjusts the desired passband width.
- ⑤ If desired, repeat steps ② to ④.
- ⑥ Push **[EXIT/SET]** to exit filter set screen.

▨ The PBT shift frequencies are cleared when the passband width is changed.

▨ This filter set screen graphically displays the PBT shift frequencies and CW pitch operations.

Mode	IF filter	Adjustable range (steps)
SSB	FIL1 (3.0 kHz)	50 to 500 Hz (50 Hz)
	FIL2 (2.4 kHz)	600 Hz to 3.6 kHz (100 Hz)
	FIL3 (1.8 kHz)	
SSB-D CW PSK	FIL1 (1.2 kHz)	50 to 500 Hz (50 Hz)
	FIL2 (500 Hz)	600 Hz to 3.6 kHz (100 Hz)
	FIL3 (250 Hz)	
RTTY	FIL1 (2.4 kHz)	50 to 500 Hz (50 Hz)
	FIL2 (500 Hz)	600 Hz to 2.7 kHz (100 Hz)
	FIL3 (250 Hz)	
AM AM-D	FIL1 (9.0 kHz)	200 Hz to 10 kHz (200 Hz)
	FIL2 (6.0 kHz)	
	FIL3 (3.0 kHz)	
FM FM-D	FIL1 (15 kHz)	Fixed
	FIL2 (10 kHz)	
	FIL3 (7.0 kHz)	

◇ Roofing filter selection



The IC-7700 has 3, 6 and 15 kHz roofing filters at the 1st IF frequency. The roofing filter provides interference reduction from nearby strong signals.

- ① Hold down **[FILTER]** for 1 second to enter filter set screen.
- ② Select any mode except FM.
- ③ Push **[ROOFING]** **[F-6]** to select the desired filter width from 15 kHz, 6 kHz and 3 kHz.
  - Hold down **[DEF]** **[F-4]** for 1 second to select a default value.
- ④ Push **[EXIT/SET]** to exit filter set screen.

• Default roofing filter (unit: kHz)

Mode	FIL1	FIL2	FIL3	Mode	FIL1	FIL2	FIL3
SSB	15	15	6	RTTY	15	6	6
SSB-D	6	6	6	PSK	6	6	6
CW	6	6	6	AM	15	15	15

◇ DSP filter shape



The type of DSP filter shape for each SSB, SSB data and CW can be selected independently from soft and sharp.

- ① Hold down **[FILTER]** for 1 second to enter filter set screen.
- ② Select SSB, SSB data or CW mode.
- ③ Push **[SHAPE]** **[F-7]** to select the desired filter shape from soft and sharp.
- ④ Push **[EXIT/SET]** to exit filter set screen.

The filter shape can be set for each band (HF and 50 MHz bands), mode, as well as the passband width setting (CW only) independently from your default setting in filter shape set mode.

◇ Filter shape set mode

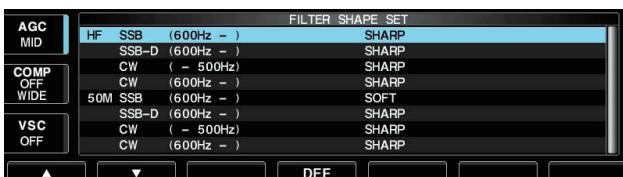

The type of DSP filter shape for SSB, SSB data and CW can be selected independently from soft and sharp.

- ① Hold down **[FILTER]** for 1 second to enter filter set screen.
- ② Hold down **[SHAPE]** **[F-7]** for 1 second to enter filter shape set mode.
- ③ Push **[▲]** **[F-1]** or **[▼]** **[F-2]** to select the desired item.
- ④ Rotate the main dial to select the filter shape from soft and sharp.
- ⑤ Push **[EXIT/SET]** to exit filter shape set mode.

◇ Filter shape set mode (continued)

<b>HF SSB (600Hz - )</b>	<b>SHARP</b>
Select the filter shape for SSB mode in HF bands.	▨ The set filter shape is automatically used only when the IF filter is set to 600 Hz or wider.
<b>SSB-D (600Hz - )</b>	<b>SHARP</b>
Select the filter shape for SSB data mode in HF bands.	▨ The set filter shape is automatically used only when the IF filter is set to 600 Hz or wider.
<b>CW ( - 500Hz)</b>	<b>SHARP</b>
Select the filter shape for CW mode in HF bands.	▨ The set filter shape is automatically used only when the IF filter is set to 500 Hz or narrower.
<b>CW (600Hz - )</b>	<b>SHARP</b>
Select the filter shape for CW mode in HF bands.	▨ The set filter shape is automatically used only when the IF filter is set to 600 Hz or wider.
<b>50M SSB (600Hz - )</b>	<b>SOFT</b>
Select the filter shape for SSB mode in 50 MHz band.	▨ The set filter shape is automatically used only when the IF filter is set to 600 Hz or wider.
<b>SSB-D (600Hz - )</b>	<b>SHARP</b>
Select the filter shape for SSB data mode in 50 MHz band.	▨ The set filter shape is automatically used only when the IF filter is set to 600 Hz or wider.
<b>CW ( - 500Hz)</b>	<b>SHARP</b>
Select the filter shape for CW mode in 50 MHz band.	▨ The set filter shape is automatically used only when the IF filter is set to 500 Hz or narrower.
<b>CW (600Hz - )</b>	<b>SHARP</b>
Select the filter shape for CW mode in 50 MHz band.	▨ The set filter shape is automatically used only when the IF filter is set to 600 Hz or wider.



## ■ Noise blanker

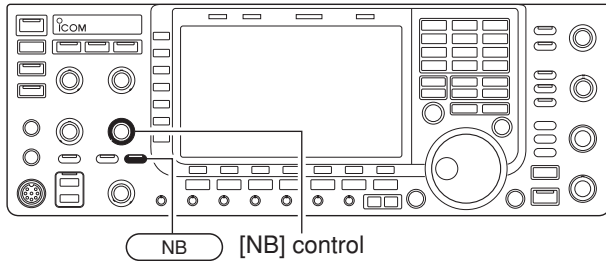

The noise blanker eliminates pulse-type noise such as the noise from car ignitions. The noise blanker is not available for FM mode.

- ① Push **[NB]** to turn the noise blanker function ON or OFF.
  - [NB] indicator above this switch lights green.
- ② Rotate [NB] control to adjust the noise blanker threshold level.

When using the noise blanker, received signals may be distorted if they are excessively strong or for other types of noise than impulse. Turn the noise blanker OFF, or rotate [NB] control to a shallow position in this case.

## ◇ NB set mode

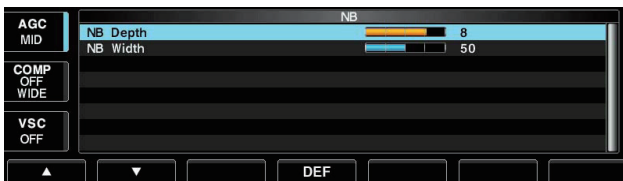

To deal with various type of noise, attenuation level and noise blanking duration can be set in NB set mode.

- ① Hold down **[NB]** for 1 second to enter NB set mode.
- ② Push **[▲]** **[F-1]** or **[▼]** **[F-2]** to select the desired item.
- ③ Rotate the main dial to set the desired level or value.
  - Hold down **[DEF]** **[F-4]** for 1 second to select a default value.
- ④ Push **[EXIT/SET]** to exit NB set mode.

### NB Depth



Set the noise attenuation level from 1 to 10.

### NB Width



Set the blanking duration from 1 to 100.

## ■ Noise reduction

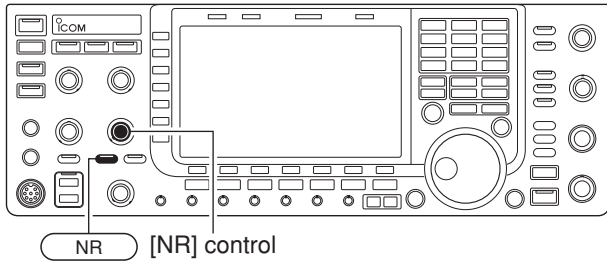

The noise reduction function reduces random noise components and enhances desired signals which are buried in noise. The DSP performs the random noise reduction function.

- ① Push **[NR]** to turn the noise reduction ON.
  - [NR] indicator above this switch lights green.
- ② Rotate the [NR] control to adjust the noise reduction level.
- ③ Push **[NR]** to turn the noise reduction OFF.
  - [NR] indicator lights off.

Large rotations of the [NR] control results in audio signal masking or distortion. Set the [NR] control for maximum readability.

## ■ Dial lock function

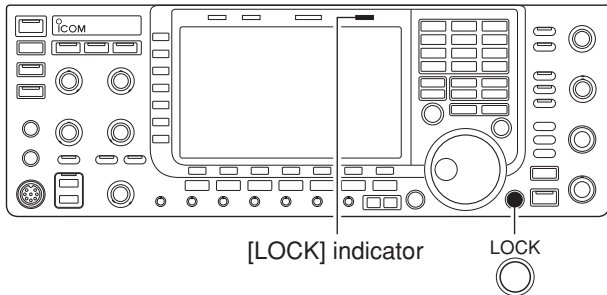

The dial lock function prevents frequency changes by accidental movement of the tuning dial. The lock function electronically locks the dial.

- ➔ Push **[LOCK]** to toggle the dial lock function ON or OFF.
  - The [LOCK] indicator lights when the dial lock function is in use.

## ■ Notch function

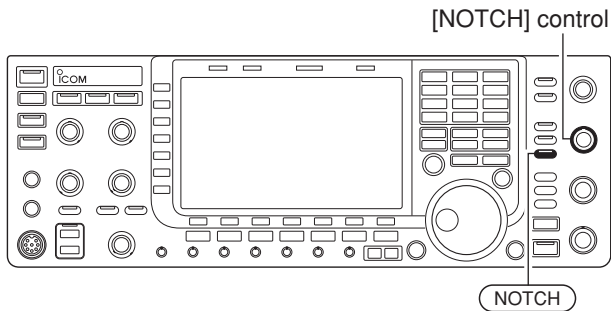

### • Auto notch indication



### • Manual notch indication



This transceiver has auto and manual notch functions. The auto notch function uses DSP to automatically attenuate beat tones, tuning signals, etc., even if they are moving. The manual notch can be set to attenuate a frequency via the [NOTCH] control. The auto notch can be used in SSB, AM and FM mode. The manual notch can be used in SSB, CW, RTTY, PSK and AM modes.

- ➔ Push [NOTCH] to toggle the notch function between auto, manual and OFF in the SSB and AM modes.
- ➔ Push [NOTCH] to turn the manual notch function ON or OFF in the CW, RTTY, PSK modes.
- ➔ Push [NOTCH] to turn the auto notch function ON or OFF in the FM mode.
  - [NOTCH] indicator above this switch lights green.
  - Hold down [NOTCH] for 1 second to select the notch filter width for manual notch from wide, middle and narrow.
  - Set to attenuate a frequency for manual notch via the [NOTCH] control.
  - “AN” appears when auto notch is in use.
  - “MN” appears when manual notch is in use.

While tuning the manual notch, noise may be heard. This comes from the DSP unit and does not indicate an equipment malfunction.

## ■ Digital selector

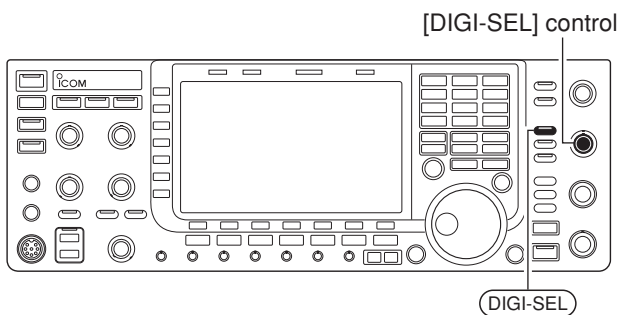

The digital selector manually adjusts the center frequency of the automatic pre-selector. The available frequency is between the 1.5 MHz to 29.999999 MHz range.

The automatic pre-selector adds selectivity ahead of the 1st mixer. This reduces intermodulation distortion from strong signals near the received frequency.

The automatic pre-selector tracks the frequency tuning, changing its center frequency in discrete steps.

- ① Push [DIGI-SEL] to turn the digital selector ON or OFF.
  - [DIGI-SEL] indicator above this switch lights green.
- ② Rotate [DIGI-SEL] control to adjust the center frequency.

**NOTE:**

- When rotating the main dial while the digital selector is activated, mechanical noise may be heard due to the switching noise from internal relays.
- The preamp (P.AMP1 or P.AMP2) cannot be used while the digital selector is activated.

## ■ Audio scope screen

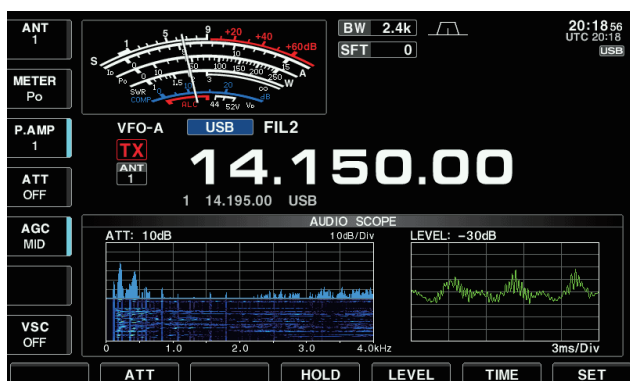
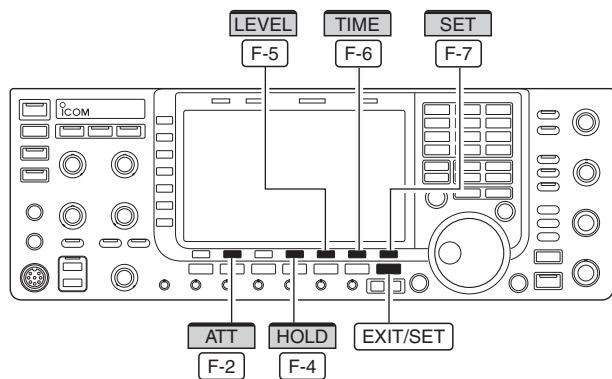

This audio scope allows you to display the received signal's frequency component to the FFT scope, and its waveform component to the Oscilloscope. The FFT scope has a waterfall.

- ① Push [EXIT/SET] several times to close any multi-function screens, if necessary.
- ② Push [AUDIO] [F-6] to select the scope screen.
- ③ Push [ATT] [F-2] several times to activate an attenuator or turn OFF the attenuator for the FFT scope.
  - 0 (OFF), 10, 20 and 30 dB attenuators are selectable.
  - Holding down [ATT] [F-2] for 1 second to turn the attenuator OFF.
- ④ Push [LEVEL] [F-5] to select the level setting for the Oscilloscope.
  - 0, -10, -20 and -30 dB are selectable.
- ⑤ Push [TIME] [F-6] several times to select the time setting for the Oscilloscope.
  - 1, 3, 10, 30, 100 and 300 ms/Div are selectable.
- ⑥ Push [HOLD] [F-4] to freeze the current audio waveform.
  - “[HOLD]” appears while the function is in use.
- ⑦ Push [EXIT/SET] to exit the scope screen.

When the Monitor function is ON, you can see the TX audio on the Audio scope.

- Rotate [MONI GAIN] to adjust the level setting for the TX audio.

### • Audio scope

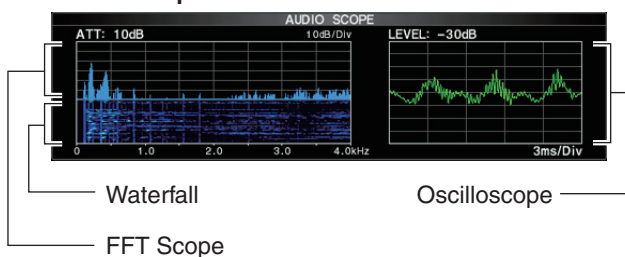

◇ Audio scope set mode

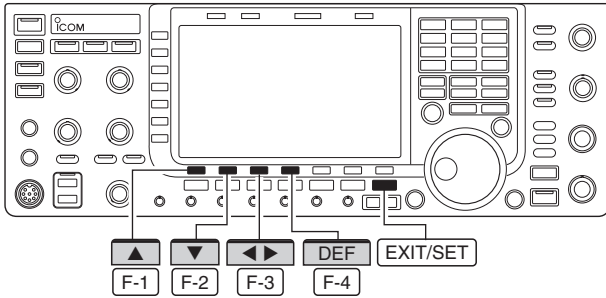

This set mode is used to set the FFT scope waveform type, color, waterfall display and oscilloscope waveform color.

- ① During audio scope display ON, push [SET] [F-7] to select the Audio scope set mode screen.
- ② Push [▲] [F-1] or [▼] [F-2] to select the desired set item.
- ③ Set the desired condition using the main dial.
  - Hold down [DEF] [F-4] for 1 second to select the default condition or value.
  - Push [◀▶] [F-3] to select the set contents for some items.
- ④ Push [EXIT/SET] to exit from set mode.

<b>FFT Scope Waveform Type</b>	<b>Fill</b>
Select the waveform type for the FFT scope.	<ul style="list-style-type: none"> <li>• Fill : The waveform is represented by the color.</li> <li>• Line : The waveform is represented by outline.</li> </ul>
<b>FFT Scope Waveform Color</b>	
Set the waveform color for the FFT scope.	<ul style="list-style-type: none"> <li>• The color is set in RGB format.</li> <li>• Push [F-3•◀▶] to select R (Red), G (Green) and B (Blue), and rotate the ratio from 0 to 255 range.</li> <li>• The set color is indicated in the box beside the RGB scale.</li> </ul>
<b>FFT Scope Waveform Display</b>	<b>ON</b>
Select the waterfall display ON or OFF.	<ul style="list-style-type: none"> <li>• ON : Displays the waterfall on the FFT scope.</li> <li>• OFF : Does not display the waterfall.</li> </ul>
<b>Oscilloscope Waveform Color</b>	
Set the waveform color for the Oscilloscope.	<ul style="list-style-type: none"> <li>• The color is set in RGB format.</li> <li>• Push [F-3•◀▶] to select R (Red), G (Green) and B (Blue), and rotate the ratio from 0 to 255 range.</li> <li>• The set color is indicated in the box beside the RGB scale.</li> </ul>

## ■ Autotune function

The Automatic tuning function tunes the displayed frequency (maximum CW:  $\pm 500$  Hz, AM:  $\pm 5$  kHz) automatically when an off-frequency signal is received. This function is active while in CW or AM mode is selected.

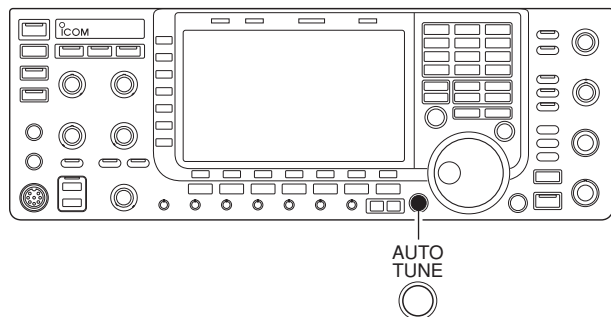

➔ Push [AUTOTUNE] to toggle the autotune function ON or OFF.

- “**AUTOTUNE**” blinks when autotune function is activated.
- After 2 seconds has passed, the autotune function stops tuning automatically even it's still off-frequency.

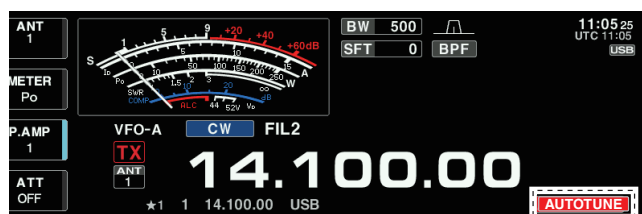

Appears

### /// **IMPORTANT!**

When receiving a weak signal, or receiving a signal with interference, the automatic tuning function may tune the receiver to an undesired signal.

---

■ VOX function .....	6-2
◇ Using the VOX function .....	6-2
◇ Adjusting the VOX function .....	6-2
◇ VOX set mode .....	6-2
■ Break-in function .....	6-3
◇ Semi break-in operation .....	6-3
◇ Full break-in operation .....	6-3
■ ΔTX function .....	6-4
◇ ΔTX monitor function .....	6-4
■ Monitor function .....	6-4
■ Transmit filter width setting (SSB only) .....	6-5
■ Speech compressor (SSB only) .....	6-5
■ Split frequency operation .....	6-6
■ Quick split function .....	6-7
◇ Split lock function .....	6-7

## ■ VOX function

### ◇ Using the VOX function

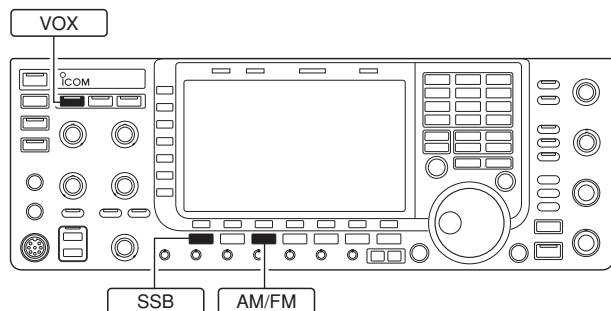

- ① Select a phone mode (SSB, AM, FM).
- ② Push **[VOX]** to turn the VOX function ON or OFF.
  - “**VOX**” appears while the VOX is in use.
  - **[VOX]** indicator above this switch lights green.

### ◇ Adjusting the VOX function

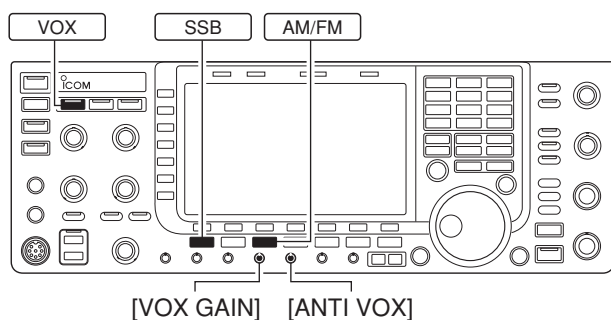



- ① Select a phone mode (SSB, AM, FM).
- ② Push **[VOX]** to turn VOX function ON.
- ③ While speaking into the microphone with your normal voice level, rotate **[VOX GAIN]** to the point where the transceiver is continuously transmitting.
- ④ During receive, rotate **[ANTI VOX]** to the point where the transceiver does not switch to transmit due to received audio from the speaker.
- ⑤ Adjust the VOX delay and the VOX voice delay in VOX set mode, if necessary.

### ◇ VOX set mode



- ① Hold down **[VOX]** for 1 second to enter VOX set mode.
- ② Select the desired item using **[▲]** **[F-1]** or **[▼]** **[F-2]**.
- ③ Rotate the main dial to the desired set value or condition.
  - Hold down **[DEF]** **[F-4]** for 1 second to select a default value.
- ④ Push **[EXIT/SET]** to exit VOX set mode.

<b>VOX Delay</b>	 <b>0.2s</b>
Set the VOX delay for a convenient interval before returning to receive within 0 to 2.0 seconds range.	
<b>VOX Voice Delay</b>	<b>OFF</b>
Set the VOX voice delay to prevent clipping of the first few syllables of a transmission when switching to transmit. Short, Mid., Long and OFF settings are available.	 When using the VOX voice delay, turn the TX monitor function OFF to prevent transmitted audio from be echoed.



## ■ Break-in function

The break-in function is used in CW mode to automatically toggle the transceiver between transmit and receive when keying. The IC-7700 is capable of full break-in or semi break-in.

### ◇ Semi break-in operation

During semi break-in operation, the transceiver immediately transmits when keyed and during key up periods returns to receive after a pre-set delay.

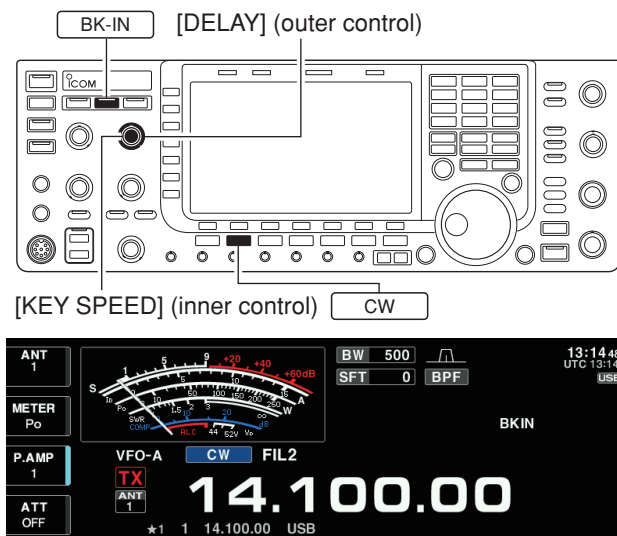

- ① Push **CW** to select CW or CW-R mode.
- ② Push **BK-IN** once or twice to turn the semi break-in function ON.
  - “**BKIN**” appears.
- ③ Rotate **[DELAY]** to set the break-in delay time (the delay from transmit to receive).

▨ When using a paddle, rotate **[KEY SPEED]** to adjust the keying speed.

### ◇ Full break-in operation

During full break-in operation, the transceiver immediately transmits when keyed and during key up periods immediately returns to receive.



- ① Push **CW** to select CW or CW-R mode.
- ② Push **BK-IN** once or twice to turn the full break-in function ON.
  - “**F-BKIN**” appears.

▨ When using a paddle, rotate **[KEY SPEED]** to adjust the keying speed.

## ■ $\Delta$ TX function

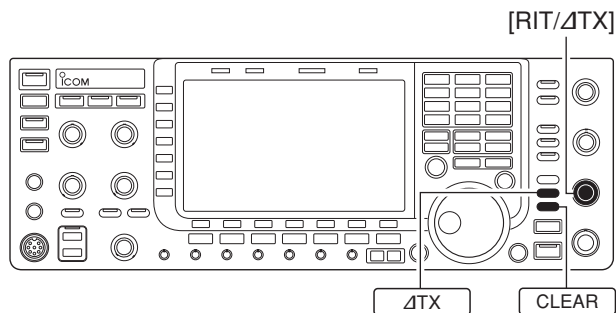

The  $\Delta$ TX function shifts the transmit frequency up to  $\pm 9.999$  kHz in 1 Hz steps (10 Hz steps when cancelling the 1 Hz step readout) without moving the receive frequency.

- ① Push  $\Delta$ TX.
  - " $\Delta$ TX" appears.
- ② Rotate [RIT/ $\Delta$ TX].
- ③ To reset the  $\Delta$ TX frequency, hold down CLEAR for 1 second.
  - Push CLEAR momentarily to reset the  $\Delta$ TX frequency when the quick RIT/ $\Delta$ TX clear function is ON. (p. 12-15)
- ④ To cancel the  $\Delta$ TX function, push  $\Delta$ TX again.
  - " $\Delta$ TX" disappears.

## ◇ $\Delta$ TX monitor function

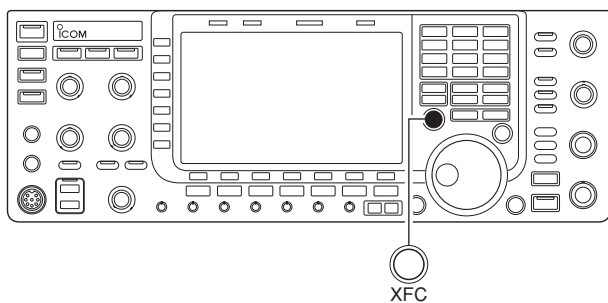

When the  $\Delta$ TX function is ON, holding down [XFC] allows you to monitor the operating frequency directly.

### ✓ For your convenience— Calculate function

The frequency shift of the  $\Delta$ TX function can be added/subtracted to the displayed frequency.

- ➡ While displaying the  $\Delta$ TX shift frequency, hold down  $\Delta$ TX for 1 second.

## ■ Monitor function

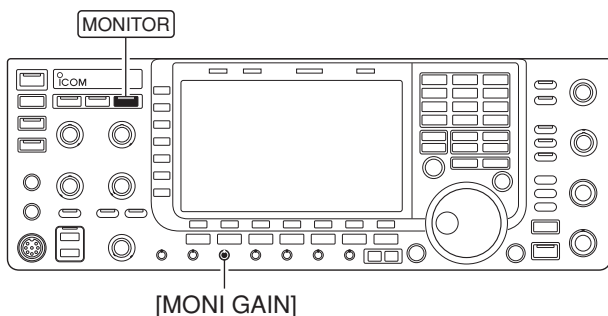

The monitor function allows you to monitor your transmit IF signals in any mode. Use this to check voice characteristics while adjusting SSB transmit parameter (p. 12-5). The CW sidetone functions regardless of the [MONITOR] switch setting.

- ① Push [MONITOR] to switch the monitor function ON and OFF.
  - [MONITOR] indicator above this switch lights green.
- ② Rotate [MONI GAIN] for the clearest audio output while pushing [PTT] and speaking into the microphone.

**NOTE:** When using the VOX voice delay, turn the monitor function OFF; or transmitted audio will be echoed.

## ■ Transmit filter width setting (SSB only)

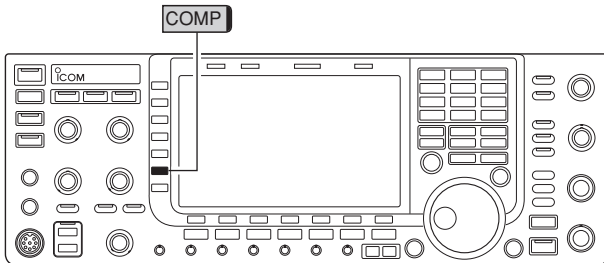

The transmit filter width for SSB mode can be selected from wide, middle and narrow.

➔ During USB or LSB mode selection, hold down [COMP] (MF6) for 1 second several times to select the desired transmit filter width from wide, middle and narrow.

- The filter can be independently set on the speech compressor function is ON or OFF.

- The following filters are specified as the default. Each of the filter width can be re-set in level set mode. (p. 12-6)

WIDE : 100 Hz to 2.9 kHz

MID : 300 Hz to 2.7 kHz

NAR : 500 Hz to 2.5 kHz

## ■ Speech compressor (SSB only)

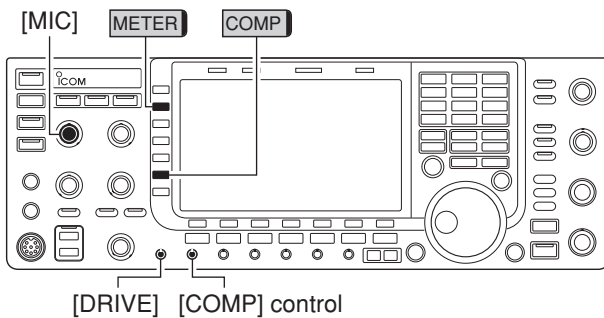

The speech compressor increases average RF output power in SSB mode only, improving signal strength and readability.

① Select USB or LSB mode and adjust [MIC] to a suitable level.

- Push [METER] (MF2) several times to select the ALC meter for microphone gain adjustment.

② Push [COMP] (MF6) to turn the speech compressor ON.

③ Push [METER] (MF2) once to select the COMP meter.

④ While speaking into the microphone, rotate [COMP] control, so that the COMP meter reads within the COMP zone (10 to 20 dB range) for your normal voice level.

⚠ When the COMP meter peaks exceed 20 dB, your transmitted voice may be distorted.

⑤ Push [METER] (MF2) 5 times to select the ALC meter.

⑥ While speaking into the microphone, rotate [DRIVE], so that the ALC meter reads within the 30 to 50% range of the ALC zone with your normal voice level.

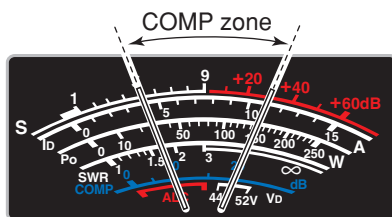

### ✓ For your convenience

Hold down [METER] (MF2) for 1 second to display the multi-function meter that can check the ALC and COMP level at a glance.

## Split frequency operation

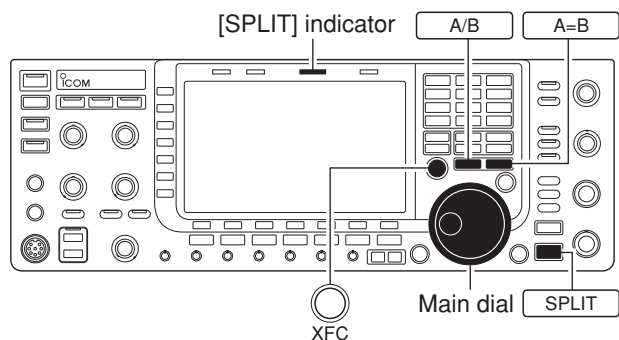

### When the split function ON

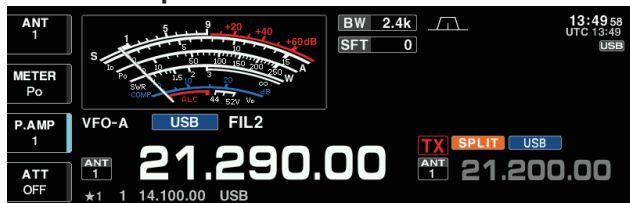

### When [XFC] is pushed

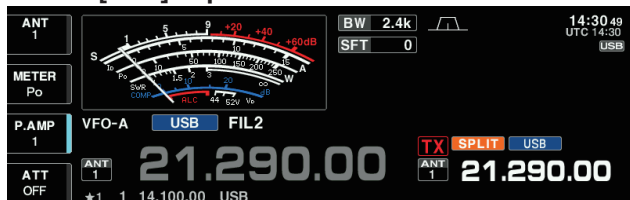

### The split frequency operation is ready

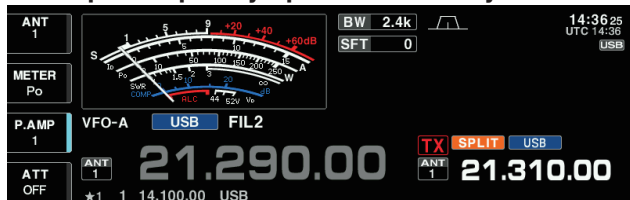

Split frequency operation allows you to transmit and receive in the same mode on two different frequencies. Split frequency operation is performed using 2 frequencies on the main and sub readouts.

The following is an example of setting 21.290 MHz for receiving and 21.310 MHz for transmitting.

- ① Set 21.290 MHz (USB) in VFO mode.
- ② Push [SPLIT] momentarily, then hold down [A=B] for 1 second.
  - The quick split function is much more convenient for selecting the transmit frequency. See the next section for details.
  - The equalized transmit frequency and “SPLIT” appear on the LCD.
  - [SPLIT] indicator lights.
  - “TX” appears to show the transmit frequency readout.
- ③ Set the transmit frequency to 21.310 MHz in the following way.
  - Rotate the main dial while pushing [XFC].
    - The transmit frequency can be monitored while pushing [XFC].
- ④ Now you can receive on 21.290 MHz and transmit on 21.310 MHz.

To change the transmit and receive frequencies, push [A/B] to exchange the main and sub readouts.

### ✓ CONVENIENT

#### Direct shift frequency input

The shift frequency can be entered directly.

- ① Push [F-INP ENT].
- ② Enter the desired shift frequency with the digit keys.
  - 1 kHz to 9.999 MHz can be set.
  - When you require a negative shift direction, push [GENE •] in advance.
- ③ Push [SPLIT].
  - The shift frequency is input in the sub readout and the split function is turned ON.

[Example]

To transmit on 1 kHz higher frequency:

  - Push [F-INP ENT], [1.8] [1] then [SPLIT].

To transmit on 3 kHz lower frequency:

  - Push [F-INP ENT], [GENE •], [7] [3] then [SPLIT].

#### Split lock function

Accidentally releasing [XFC] while rotating the main dial changes the receive frequency. To prevent this, use both the split lock and dial lock functions to change the transmit frequency only. The split lock function cancels the dial lock function while pushing [XFC] during split frequency operation.

The dial lock's effect during split frequency operation can be selected in the set mode for both receive and transmit frequencies; or only the receive frequency. (p. 12-13)

## ■ Quick split function

When you find a DX station, an important consideration is how to set the split frequency.

When you hold down the **[SPLIT]** switch for 1 second, split frequency operation is turned ON and the transmit frequency is equalized to the received frequency.

This shortens the time needed to begin split frequency operation.

The quick split function is ON by default. For your convenience, it can be turned OFF in Others set mode. (p. 12-13) In this case, the **[SPLIT]** switch does not equalize the transmit frequency to the receive frequency.

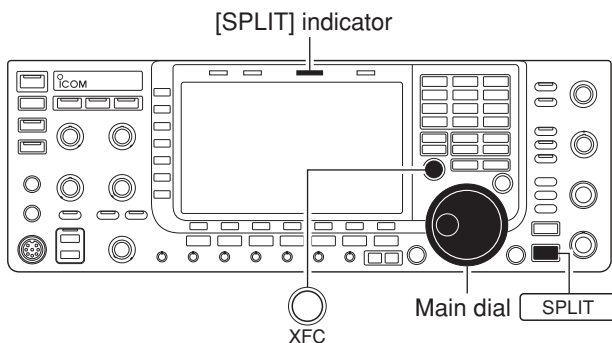

① Suppose you are operating at 21.290 MHz (USB) in VFO mode.

② Hold down **[SPLIT]** for 1 second.

- Split frequency operation is turned ON.
- The transmit frequency (unselected VFO's readout) is equalized to the receive frequency (selected VFO's readout).
- "**SPLIT**" indicator appears.

③ Enter the desired offset frequency from the keypad then push **[SPLIT]**, or set the transmit frequency with the main dial while pushing **[XFC]**.

- "**F-INP**" indicator appears when **[F-INP ENT]** is pushed.
- Offset frequency setting with the keypad— example

To transmit on 1 kHz higher frequency:

- Push **[F-INP ENT]**, **[1.8 1]** then **[SPLIT]**.

To transmit on 3 kHz lower frequency:

- Push **[F-INP ENT]**, **[GENE .]**, **[7 3]** then **[SPLIT]**.

## ◇ Split lock function

The split lock function is convenient for changing only the transmit frequency. When the split lock function is not used, accidentally releasing **[XFC]** while rotating the main dial, changes the receive frequency. The split lock function is ON by default, but can be turned OFF in set mode. (p. 12-13)

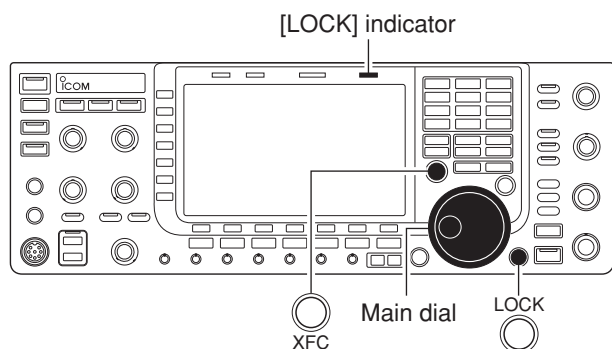

① While split frequency operation is ON, push **[LOCK]** to activate the split lock function.

② While pushing **[XFC]**, rotate the main dial to change the transmit frequency.

- If you accidentally release **[XFC]** while rotating the main dial, the receive frequency does NOT change.



- Recording a QSO audio ..... 7-2
  - ◇ To start or stop recording ..... 7-2
- Recording quick operation ..... 7-2
  - ◇ To start or stop recording ..... 7-2
- Playing back the recorded audio (QSO) ..... 7-3
  - ◇ Basic playing ..... 7-3
  - ◇ Operating while playing back ..... 7-4
- Deleting recorded audio file ..... 7-5
- Deleting recorded audio folder ..... 7-5
- About digital Voice Recorder ..... 7-6
- Recording a received audio (Short REC) ..... 7-7
  - ◇ One-touch recording ..... 7-7
- Playing back the recorded audio (Short REC) ..... 7-7
  - ◇ Basic playing ..... 7-7
  - ◇ One-touch playing ..... 7-8
- Protect the recorded contents ..... 7-8
- Erasing the recorded contents ..... 7-8
- Recording a message for transmit ..... 7-9
  - ◇ Recording ..... 7-9
  - ◇ Confirming a message for transmit ..... 7-9
- Programming a memory name ..... 7-10
- Sending a recorded message ..... 7-11
  - ◇ Single TX ..... 7-11
  - ◇ Repeat TX ..... 7-11
  - ◇ Transmit level setting ..... 7-12
- Voice set mode ..... 7-13
- Saving a voice memory into the memory device ..... 7-15
  - ◇ Saving the received audio memory ..... 7-15
  - ◇ Saving the TX memory ..... 7-15

## Recording a QSO audio

**NOTE:**

- Be sure to connect a USB flash drive before recording a QSO audio.
- Once recording starts, it continues, even if the transceiver is turned OFF and then ON again.

The Voice recorder function records a QSO (communication) audio onto a USB flash drive. This function enables you to record both received and transmitted audio, a QSO with a DX'pedition, and playback the recorded audio after the QSO.

### ◇ To start or stop recording

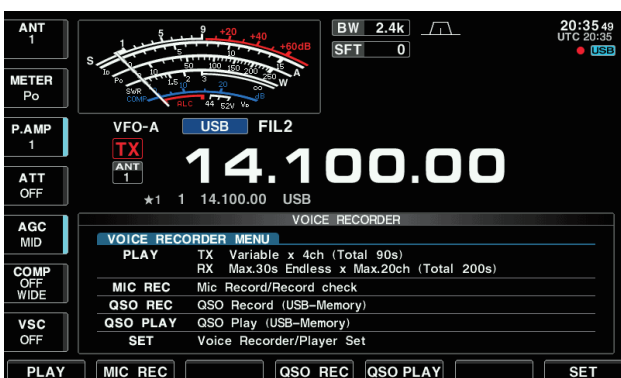
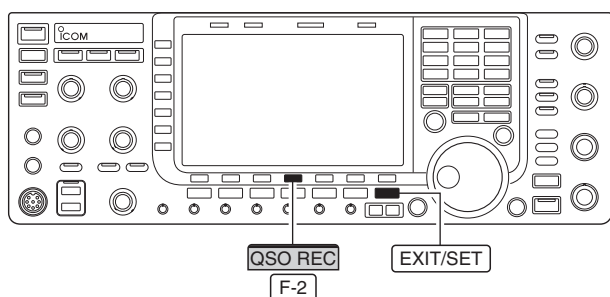

- ① Push [EXIT/SET] several times to close a multi-function screen, if necessary.
- ② Push [VOICE] [F-2] to display the Voice Recorder menu.
- ③ Hold down [QSO REC] [F-4] for 1 second to start voice recording.
  - The “●” indicator appears and the “USB” indicator blinks.
  - Recording is continuous until you manually stop recording, or the USB flash drive becomes full.
  - If the recording file's content reaches 2GB, the transceiver automatically creates a new file, and continues recording.
  - The “III” indicator appears instead of the “●” indicator while recording is paused.
- ④ Hold down [QSO REC] [F-4] for 1 second to stop recording.
  - The “●” indicator disappears and the “USB” indicator stops blinking.
- ⑤ Push [EXIT/SET] to exit the Voice Recorder screen.

**✓ Convenient!**

When the PTT Automatic Recording function is set to ON in the Voice set mode, the recording automatically starts when you push [PTT]. (p. 7-14)

## Recording quick operation

### ◇ To start or stop recording

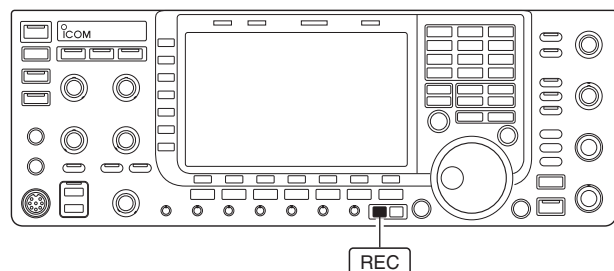

- ① Hold down [REC] for 1 second to start voice recording.
  - The “●” indicator appears and the “USB” indicator blinks.
- ② Hold down [REC] for 1 second again to stop recording.



## ■ Playing back the recorded audio (QSO)

### ◇ Basic playing

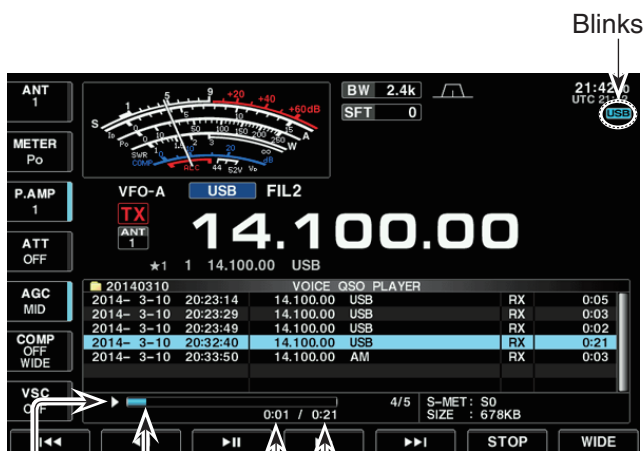
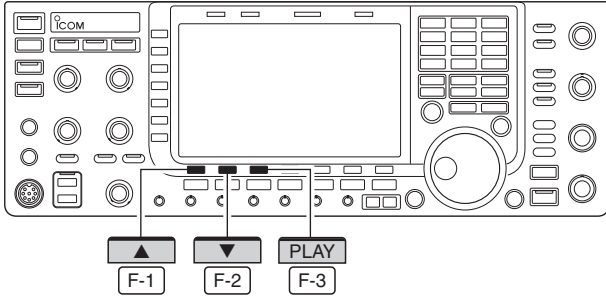

Blinks

**Progress bar**  
Shows the play back progress bar.

**Played back time**  
Shows the played back time.

**Total time**  
Shows the file's total playback time.

#### Playback mark

Appears while the audio is playing back.  
• The mark disappears while pausing.

- ① Push [EXIT/SET] several times to close a multi-function screen, if necessary.
- ② Push [VOICE] [F-2] to display the Voice Recorder menu.
- ③ Push [QSO PLAY] [F-5] to call up the voice QSO player screen.
  - The folder list is displayed.
  - The folder name is formatted yyyyymmdd (yyyy: year, mm: month, dd: day).
- ④ Push [▲] [F-1] or [▼] [F-2] to select the folder that contains the file you want to play.
  - Rotating the main dial also selects the folder.
- ⑤ Push [FILE] [F-3] to open the folder .
  - The file list is displayed.
  - The file name is formatted yyyy-mm-dd hh:mm:ss (yyyy: year, mm: month, dd: day, hh: hour, mm: minute, ss: second).
- ⑥ Push [▲] [F-1] or [▼] [F-2] to select the file that you want to play.
  - Rotating the main dial also selects the file.
- ⑦ Push [PLAY] [F-3] to start playback.
  - The "USB" indicator blinks.
  - Playback continues to next file, and it is terminated when the bottom file in the folder is played.
- ⑧ Push [EXIT/SET] several times to exit the QSO player screen.

## ■ Playing back the recorded audio (QSO) (continued)

### ◇ Operating while playing back

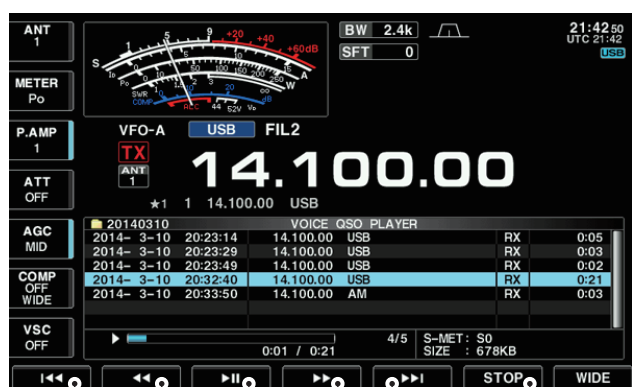
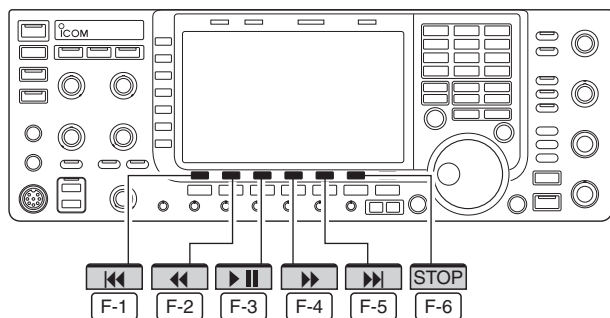

Play the previous file      Rewind      Forward      Play the next file  
 Pause or play      Stop playing

#### ✓ Convenient!

You can fast forward or rewind the file that is playing by rotating the main dial.

The fast forward/rewind time is one twentieth of the total file time, regardless of the skip time setting.

Holding down the switch repeats the action until it is released (other than the [▶||] [F-3] switch).

Example: Hold down [▶▶] [F-4] to repeat skipping 10 seconds until you release the [▶▶] [F-4] switch.

(Default: 10 seconds)

You can fast forward or rewind while playing back.

#### • Fast forward while playing

Push [▶▶] [F-4] to fast forward to the skip time point. (Default: 10 seconds)

You can change the skip time in the voice set mode. (p. 7-14)

#### • Rewind while playing

Push [◀◀] [F-2] to rewind to the skip time point. (Default: 10 seconds)

You can change the skip time in the voice set mode. (p. 7-14)

• If you push [◀◀] [F-2] within the first second of the file, the skip time at the end of the previously recorded file will playback.

#### • Pause while playing

Push [▶||] [F-3] to pause.

• Touch [▶||] [F-3] again to resume.

#### • Playing the previous file

Push [◀◀] [F-1] to play the previous file.

• In case there are other files in the folder, while the oldest file is playing back, Push [◀◀] [F-1] to start playing the beginning of the file.

#### • Playing the next file

Push [▶▶] [F-5] to play the next file.

• In case there are other files in the folder, while the most recent file is playing back, Push [▶▶] [F-5] to stop the playback.

#### • Moving to the beginning of the previous file

When the playback is paused anywhere within the file, Push [◀◀] [F-2] one or more times to return to the beginning of the file, and pause.

• Push [▶||] [F-3] to play it back.

When the playback is paused at beginning of a file, Push [◀◀] [F-1] to move to the beginning of the previous file, and pause.

• Push [▶||] [F-3] to play it back.

#### • Moving to the beginning of the next file

When the playback is paused, Push [▶▶] [F-5] to move to the beginning of the next file, and pause.

• Push [▶||] [F-3] to play it back.

## ■ Deleting recorded audio file

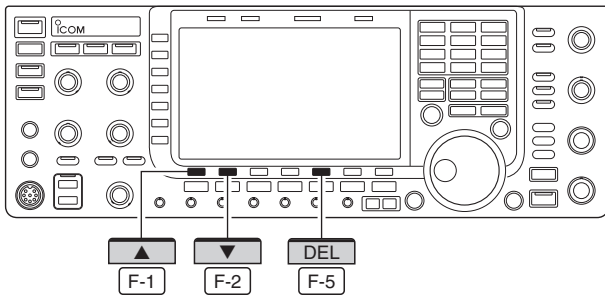

- ① Push [EXIT/SET] several times to close a multi-function screen, if necessary.
- ② Push [VOICE] [F-2] to display the Voice Recorder menu.
- ③ Push [QSO PLAY] [F-5] to call up the voice QSO player screen.
  - The folder list is displayed.
  - The folder name is formatted yyyyymmdd (yyyy: year, mm: month, dd: day).
- ④ Push [▲] [F-1] or [▼] [F-2] to select the folder that contains the file you want to delete.
  - Rotating the main dial also selects the folder.
- ⑤ Push [FILE] [F-3] to open the folder .
  - The file list is displayed.
  - The file name is formatted yyyy-mm-dd hh:mm:ss (yyyy: year, mm: month, dd: day, hh: hour, mm: minute, ss: second).
- ⑥ Push [▲] [F-1] or [▼] [F-2] to select the file that you want to delete.
  - Rotating the main dial also selects the file.
- ⑦ Hold down [DEL] [F-5] for 1 second to delete the file.
  - The confirmation window “Are you sure?” appears.
- ⑧ Push [OK] [F-6] to delete the file.
  - The selected file is deleted.
  - Push [EXIT/SET] to cancel deleting.
- ⑨ Push [EXIT/SET] several times to exit the QSO player screen.

## ■ Deleting recorded audio folder

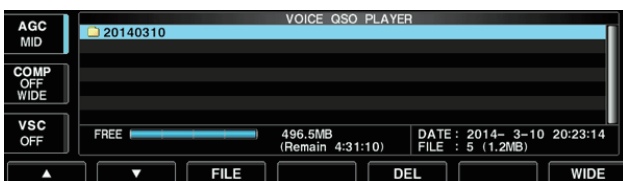
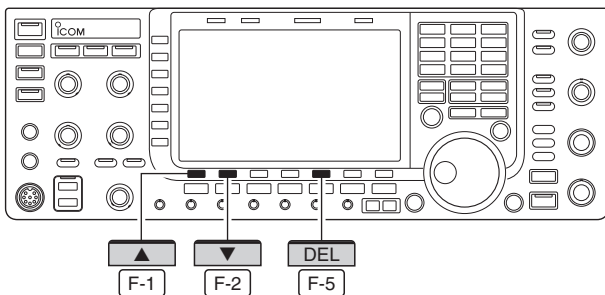

- ① Push [EXIT/SET] several times to close a multi-function screen, if necessary.
- ② Push [VOICE] [F-2] to display the Voice Recorder menu.
- ③ Push [QSO PLAY] [F-5] to call up the voice QSO player screen.
  - The folder list is displayed.
  - The folder name is formatted yyyyymmdd (yyyy: year, mm: month, dd: day).
- ④ Push [▲] [F-1] or [▼] [F-2] to select the folder that you want to delete.
  - Rotating the main dial also selects the folder.
- ⑤ Hold down [DEL] [F-5] for 1 second to delete the folder.
  - The confirmation window “Are you sure?” appears.
- ⑥ Push [OK] [F-6] to delete the folder.
  - The selected folder is deleted.
  - Push [EXIT/SET] to cancel deleting.
- ⑦ Push [EXIT/SET] several times to exit the QSO player screen.

## ■ About digital Voice Recorder

The IC-7700 has digital voice memories, up to 4 messages for transmit, and up to 20 messages for receive.

A maximum message length of 30 seconds can be recorded into a receive memory (total message length for all channels of up to 209 seconds) and a total message length of up to 99 seconds can be recorded in transmit memory.

The transmit memory is very convenient for repeated CQ and exchange transmissions in contests, as well as when making repeated calls during DX'peditions.

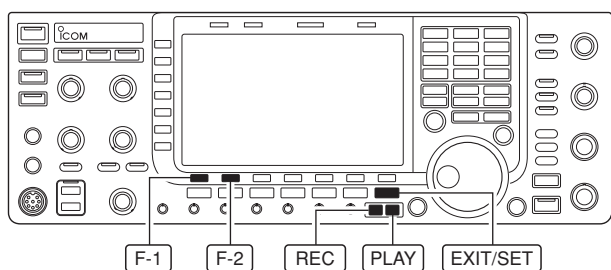

- ① Select any mode.
- ② Push [VOICE] [F-2] to display voice recorder menu.
- ③ Push [PLAY] [F-1] or [MIC REC] [F-2] to select the desired memory channel screen, then record audio or playback the contents as described below.
- ④ Push [EXIT/SET] twice to exit voice recorder screen.

### • About recording received audio and playing back the contents

#### • Example—When [REC] is pushed momentarily

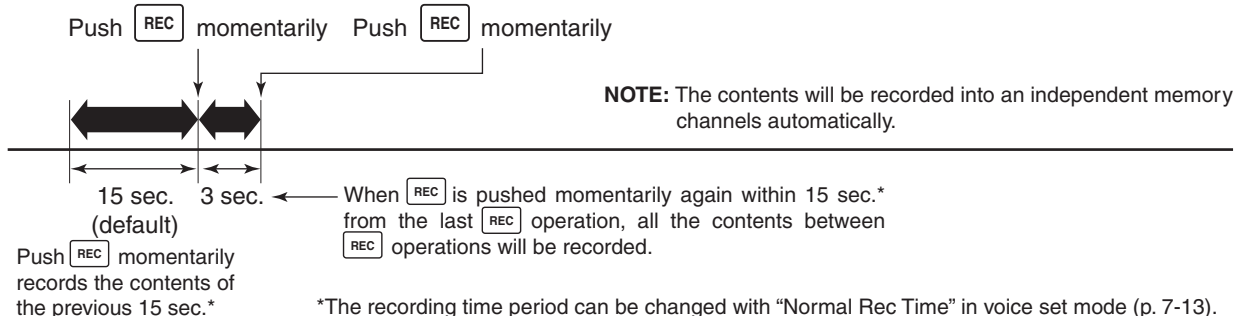

#### • Playing back the all contents in a channel

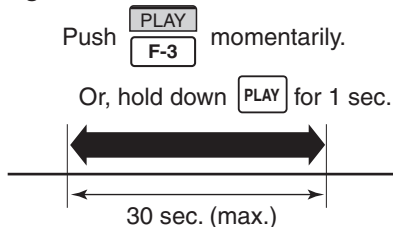

#### • Playing back the end of 5 sec.\* in a channel

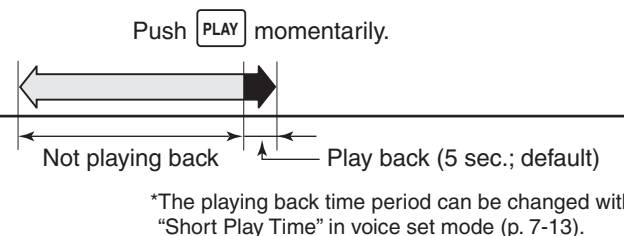

## Recording a received audio (Short REC)

Up to 20 channels of receive voice memories are available in the IC-7700. And the total audio length of up to 209 seconds can be recorded in receive channels. However, the maximum recordable length into a single memory is 30 seconds.

This Voice Recorder does not record only the received audio, but also the information such as set operating frequency, mode, and the recording time for your future reference.

### One-touch recording

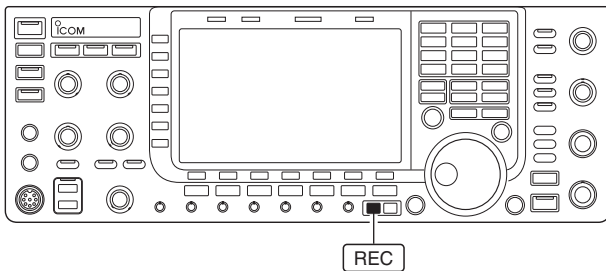

➔ Push **[REC]** momentarily to records the previous 15 seconds audio.

- The recordable time period can be set in voice set mode. (p. 7-13)
- The operating frequency, mode and current time are automatically programmed as the memory names.

**NOTE:** When transmit (or [PTT] is pushed) within the set period, no audio will be recorded.

### IMPORTANT!

When you record the 21st audio segment, or when the total audio length exceeds 209 seconds, the oldest recorded audio is automatically erased to make room for the new audio.

## Playing back the recorded audio (Short REC)

### Basic playing

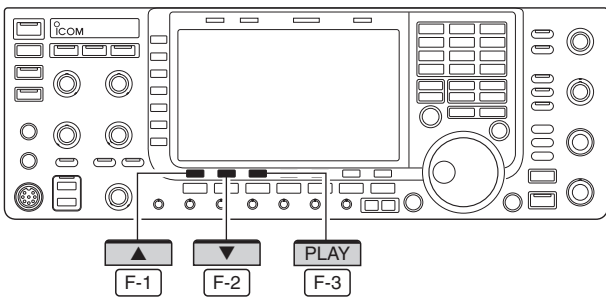

- ➊ Push **[EXIT/SET]** several times to close a multi-function screen, if necessary.
- ➋ Push **[VOICE] [F-2]** to display the Voice recorder menu.
- ➌ Push **[PLAY] [F-1]** to display the Voice recorder screen.
  - Previously selected screen, TX or RX memory, is displayed. If the TX memory message (T1–T4) appears, push **[T/R] [F-7]** to select RX memory message.
- ➍ Push **[▲] [F-1]** or **[▼] [F-2]** to select the desired voice memory to playback.
- ➎ Push **[PLAY] [F-3]** to start playback.
  - “▶PLAY” indicators appear and the timer counts down.
- ➏ Push **[PLAY] [F-3]** again to stop playback if desired.
  - Playback is terminated automatically when all of the recorded contents in the message are played.
- ➐ Push **[EXIT/SET]** twice to exit the voice recorder screen.

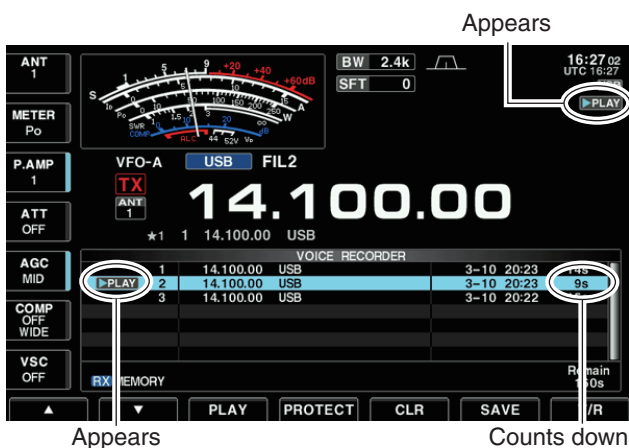

## ■ Playing the recorded audio (continued)

### ◇ One-touch playing

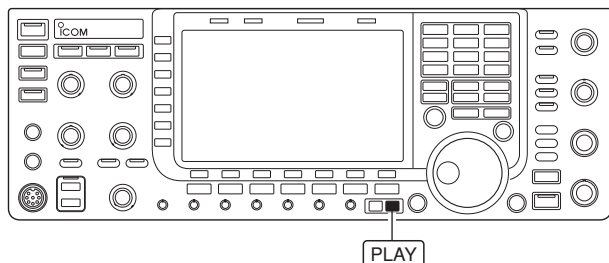

The previously recorded audio in message 1 can be played back without selecting voice recorder screen.

- ➔ Push **[PLAY]** momentarily to play back the last 5 seconds of the previously recorded audio.
  - “▶PLAY” indicator appears.
  - Playback is terminated automatically after 5 seconds.
  - The playback time period can be set in voice set mode. (p. 7-13)
- ➔ Hold down **[PLAY]** for 1 second to playback all of the previously recorded audio.
  - “▶PLAY” indicator appears.
  - Playback is terminated automatically when all of the recorded contents in the channel are played.

## ■ Protect the recorded contents

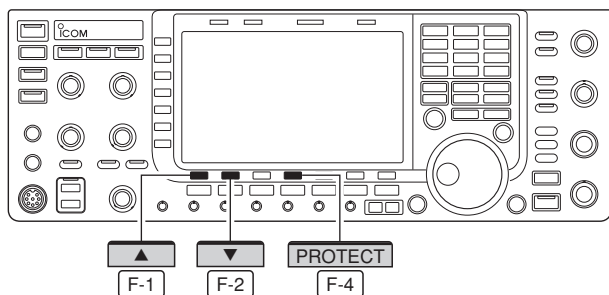

The protect function is available to protect the recorded contents from accidental erasure, such as over-writing, etc.

- ① Push **[EXIT/SET]** several times to close a multi-function screen, if necessary.
- ② Push **[VOICE] [F-2]** to display the Voice recorder menu.
- ③ Push **[PLAY] [F-1]** to display the Voice recorder screen.
  - Previously selected screen, TX or RX memory, is displayed. If the TX memory message (T1–T4) appears, push **[T/R] [F-7]** to select RX memory message.
- ④ Push **[▲] [F-1]** or **[▼] [F-2]** to select the desired voice message.
- ⑤ Push **[PROTECT] [F-4]** to turn the protect function ON or OFF.
  - “🔒” indicator appears when the contents is protected.
- ⑥ Push **[EXIT/SET]** twice to exit the voice recorder menu.

## ■ Erasing the recorded contents

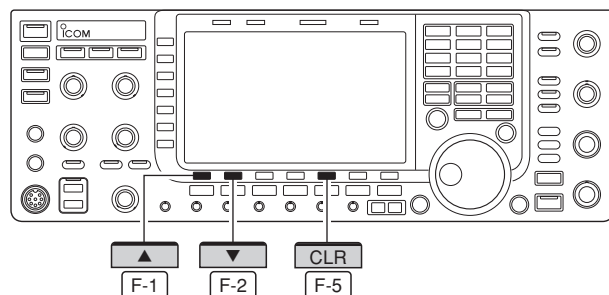

The recorded contents can be erased independently by message.

- ① Perform the steps ① to ③ as “■ Protect the recorded contents” above.
- ② Push **[▲] [F-1]** or **[▼] [F-2]** to select the desired voice message to be erased.
- ③ Hold down **[CLR] [F-5]** for 1 second to erase the contents.
  - Push **[PROTECT] [F-4]** to release the protection in advance if necessary.
- ④ Push **[EXIT/SET]** twice to exit the voice recorder menu.

## ■ Recording a message for transmit

To transmit a message using the Voice recorder, record the desired message in advance as described below. The IC-7700 has digital voice memories for transmission, up to 4 messages and you can record message in length of up to 99 seconds.

### ◇ Recording

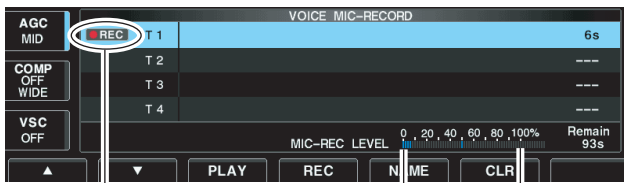
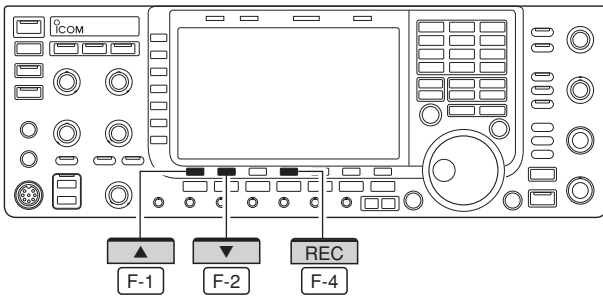

Appears

Adjust [MIC] control so that this indicator reads within 100%.

- ① Push [EXIT/SET] several times to close a multi-function screen, if necessary.
- ② Push [VOICE] [F-2] to display the Voice recorder menu.
- ③ Push [MIC REC] [F-2] to select the voice mic. record screen.
- ④ Push [▲] [F-1] or [▼] [F-2] to select the desired message.
- ⑤ Hold down [REC] [F-4] for 1 second to start recording.
  - “**REC**” indicator appears.
  - Speak into the microphone without holding down [PTT].
  - Previously recorded contents are cleared.
  - Audio output from the internal speaker is automatically muted.
- ⑥ While speaking into the microphone with your normal voice level, adjust the [MIC] control so that the [MIC-REC LEVEL] indicator reads within 100%.
- ⑦ Push [REC] [F-4] momentarily to stop recording.
  - The recording is terminated automatically when the remaining time becomes 0 second.
- ⑧ Push [EXIT/SET] twice to exit the Voice recorder menu.

### ◇ Confirming a message for transmit

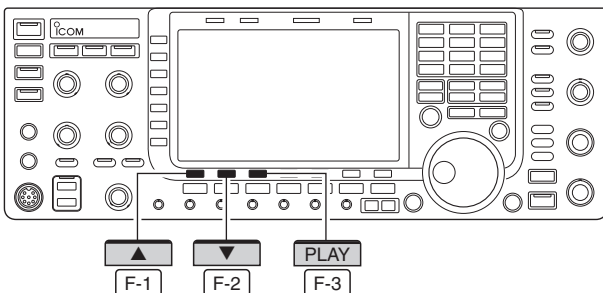

- ① Perform the steps ① to ③ as “◇ Recording” above.
- ② Push [▲] [F-1] or [▼] [F-2] to select the desired message.
- ③ Push [PLAY] [F-3] to playback the recorded contents.
  - “**▶PLAY**” indicator appears.
- ④ Push [PLAY] [F-3] again to stop playback.
  - Playback is terminated automatically when all of the recorded contents in the message are played.
- ⑤ Push [EXIT/SET] twice to exit the voice recorder screen.

## ■ Programming a memory name

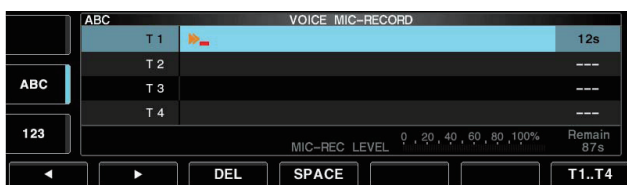
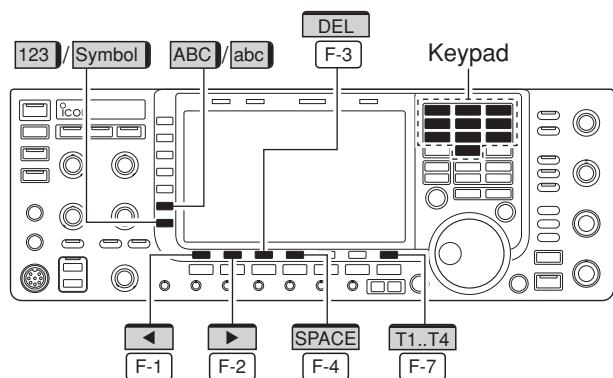

### • Voice memory name editing example

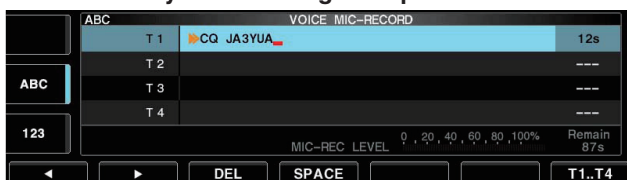

Memory messages can be tagged with alphanumeric names of up to 20 characters each.

Capital letters, small letters, numerals, some symbols (! # \$ % & ¥ ? “ ` ^ + - \* / . , ; = < > ( ) [ ] { } | \_ ~ @) and spaces can be used. (See the table below.)

- ① Record a message as described in page 7-9.
- ② During the voice mic. record screen display, push [NAME] [F-5] to enter memory name edit condition.
  - A cursor appears and blinks.
- ③ Push [T1..T4] [F-7] several times to select the desired voice message.
- ④ Input the desired character by rotating the main dial or by pushing the band key for number input.
  - Push [ABC] (MF6) or [abc] (MF6) to toggle capital and small letters.
  - Push [123] (MF7) or [Symbol] (MF7) to toggle numerals and symbols.
  - Push [◀] [F-1] or [▶] [F-2] for cursor movement.
  - Push [DEL] [F-3] to delete the selected character.
  - Push [SPACE] [F-4] to input a space.
  - Pushing the transceiver’s keypad, [0]–[9], can also enter numerals.
- ⑤ Push [EXIT/SET] to input and set the name.
  - The cursor disappears.
- ⑥ Repeat steps ③ to ⑤ to program another voice message’s name, if desired.
- ⑦ Push [EXIT/SET] twice to exit the voice recorder screen.

### • Usable characters

Key selection	Editable characters
<b>ABC</b>	A to Z (capital letters)
<b>abc</b>	a to z (small letters)
<b>123</b>	0 to 9 (numbers)
<b>Symbol</b>	! # \$ % & ¥ ? “ ` ^ + - * / . , ; = < > ( ) [ ] { }   _ ~ @

#### ✓ For your convenience

When a PC keyboard is connected to [USB] connector on the front panel, the memory name can also be edited from the keyboard.



## ■ Sending a recorded message

### ◇ Single TX

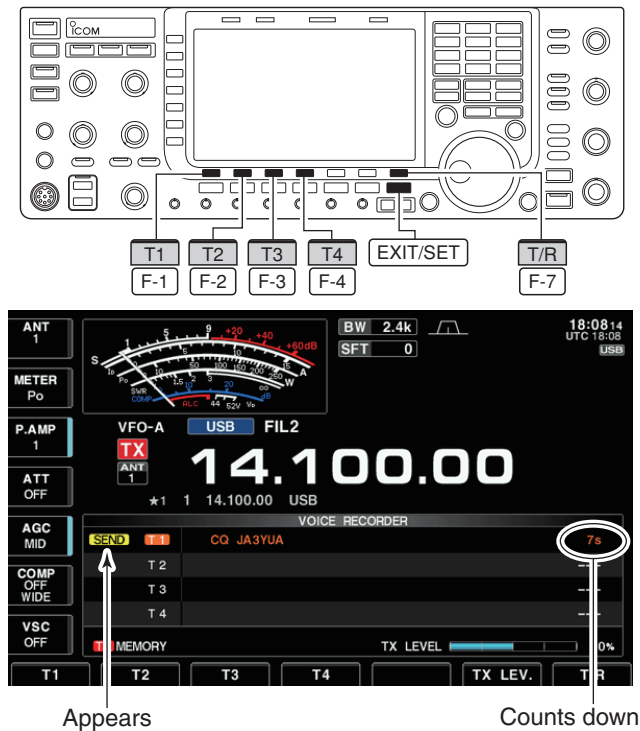

- ① Push [EXIT/SET] several times to close a multi-function screen, if necessary.
- ② Select a phone mode by pushing [SSB] or [AM/FM].
- ③ Push [VOICE] [F-2] to enter the Voice recorder menu.
- ④ Push [PLAY] [F-1] to enter the Voice recorder screen.
  - If the receive voice message appears, push [T/R] [F-7] to select TX message (T1–T4).
- ⑤ Push a desired message switch, [T1] [F-1] to [T4] [F-4], to transmit the contents.
  - The transceiver transmits automatically.
  - “SEND” indicator appears and the memory timer counts down.
  - You hear the transmitted message from the speaker as the default. This can be turned OFF in voice set mode. (p. 7-13)
- ⑥ Push the selected message switch, [T1] [F-1] to [T4] [F-4], again to stop, if desired.
  - The transceiver returns to receive automatically when all of the recorded contents in the message are transmitted.
- ⑦ Push [EXIT/SET] twice to exit the voice memory screen.

### ◇ Repeat TX

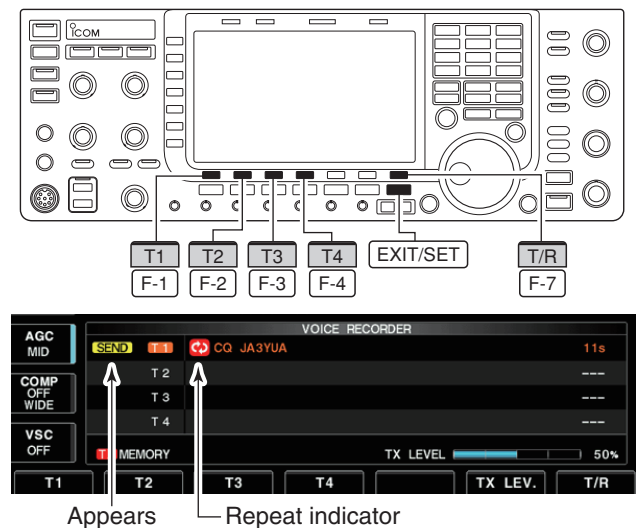

- ① Perform steps ① to ④ above.
- ② Hold down a desired message switch, [T1] [F-1] to [T4] [F-4], for 1 second to repeatedly transmit the recorded voice audio for up to 10 minutes at the interval specified in “Repeat Time.”
  - Even if 10 minutes pass while transmitting, the voice audio is completely transmitted.
  - One of the following steps will cancel the transmission.
    - Push the memory again.
    - Push another memory (except for [TX LEV.]).
    - Exit the TX Voice memory screen.
    - Turn OFF the power, then turn it ON again.
    - Activate the transmission.
  - The repeat transmission is cancelled. But while transmitting, the voice audio is completely transmitted.
  - Once the Repeat TX is made, the transceiver pauses until the end of the “Repeat Time,” then transmits again. After the second transmission, the Repeat TX continues pausing, if receiving a signal. But if the squelch is manually opened, the voice audio is repeatedly transmitted, according to the repeat time setting.

#### ✓ For your convenience

When an external keypad or PC keyboard is connected, the recorded message, T1 to T4, can be transmitted without opening the Voice Recorder screen. See pages 2-6, 2-7 and 12-17 for details.

- The recorded message, T1 to T4 is transmitted once when pushing one of four switches on the external keypad; the recorded message is repeatedly transmitted when holding down a switch.
- The recorded message, T1 to T4 is transmitted once when pushing one of [F1] to [F4] key on the PC keyboard; the recorded message is repeatedly transmitted when pushing a key while holding down [SHIFT] key.

## ■ Sending a recorded message (continued)

### ◇ Transmit level setting

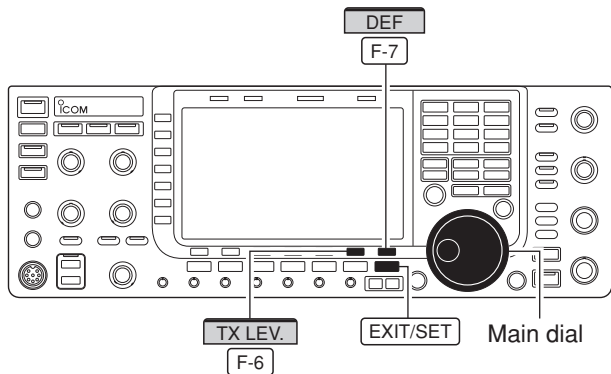

- ① Call up the Voice recorder screen as described above.
- ② Push [TX LEV.] [F-6] to select the voice memory transmit level set condition.
- ③ Push the desired message switch, [T1] [F-1] to [T4] [F-4], momentarily to transmit the contents.
  - The transceiver transmits automatically.
  - “SEND” indicator appears and the memory timer counts down.
- ④ Rotate the main dial to adjust the transmit voice level.
  - Hold down [DEF] [F-7] for 1 second to select the default condition.
- ⑤ Push [EXIT/SET] to return to the voice recorder screen.

## ■ Voice set mode

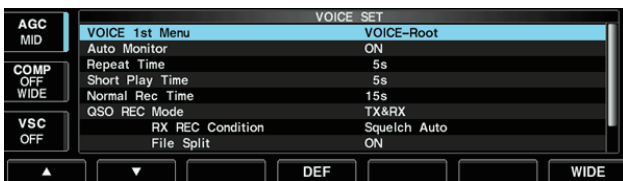
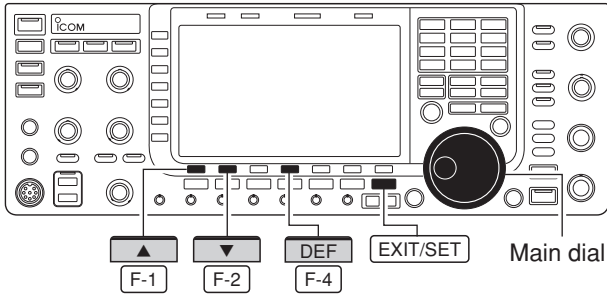

Sets the automatic monitor function, short play and normal recording times for voice recorder.

- ① Push [EXIT/SET] several times to close a multi-function screen, if necessary.
- ② Push [VOICE] [F-2] to display the Voice recorder menu.
- ③ Push [SET] [F-7] to select voice set mode screen.
- ④ Push [▲] [F-1] or [▼] [F-2] to select the desired item.
- ⑥ Rotate the main dial to set the desired condition or value.
  - Hold down [DEF] [F-4] for 1 second to select the default condition or value.
- ⑦ Push [EXIT/SET] to exit the voice set mode screen.

Voice 1st Menu	VOICE-Root
Select VOICE-Root or VOICE-PLAY as the menu that appears first after pushing [VOICE] [F-2].	<ul style="list-style-type: none"> <li>• VOICE-Root : The voice menu appears first.</li> <li>• VOICE-PLAY : Either the RX or TX voice Recorder screen appears first.</li> </ul>
Auto Monitor	ON
Turn on the automatic monitor function for recorded audio contents transmission.	<ul style="list-style-type: none"> <li>• ON : Monitors transmit audio automatically when sending a recorded audio.</li> <li>• OFF : Monitors transmit audio only when the monitor function is in use.</li> </ul>
Repeat Time	5s
Set the repeat interval for the voice repeat transmission to between 1 and 15 seconds (in 1 second steps). The transceiver repeatedly transmits the recorded voice audio at this interval.	
Short Play Time	5s
Set the desired time period for one-touch playback (when [PLAY] is pushed momentarily).	<ul style="list-style-type: none"> <li>• 3 to 10 seconds in 1 second steps can be set. (default: 5 seconds)</li> </ul>
Normal Rec Time	15s
Set the desired time period for one-touch recording (when [REC] is pushed momentarily).	<ul style="list-style-type: none"> <li>• 5 to 30 seconds in 1 second steps can be set. (default: 15 seconds)</li> </ul>

■ Voice set mode (continued)

<b>QSO REC Mode</b>	<b>TX&amp;RX</b>
Select the recording mode for recording a QSO audio.	<ul style="list-style-type: none"> <li>• TX&amp;RX : Records both the transmitted and received audio.</li> <li>• RX only : Records only the received audio.</li> </ul>
<b>RX REC Condition</b>	<b>Squelch Auto</b>
Select whether or not the squelch status affects the RX voice audio recording.	<ul style="list-style-type: none"> <li>• Always: The transceiver always records the RX audio, regardless of the squelch status.</li> <li>• Squelch Auto: The transceiver records the RX audio only when a signal is received (the squelch is opened). When the squelch closes while recording, the recording will continue for 2 seconds, and then pause.</li> </ul>
<b>File Split</b>	<b>ON</b>
Turn the File Split function ON or OFF.	<ul style="list-style-type: none"> <li>• OFF: The audio is continuously recorded into the file, even if you switch between transmit and receive or the squelch status changes between open and closed.</li> <li>• ON: While recording, and if you switch between transmit and receive, or the squelch status changes between open and closed, a new file is automatically created in the same folder, and the audio is saved into the new one.</li> </ul>
<b>PTT Auto REC</b>	<b>OFF</b>
Turn the PTT Automatic Recording function ON or OFF.	<ul style="list-style-type: none"> <li>• OFF: The recording does not start even if a signal is transmitted.</li> <li>• ON: The recording automatically starts when a signal is transmitted. The recording will continue when: <ul style="list-style-type: none"> <li>• A signal is transmitted again within 10 seconds after the last transmission.</li> <li>• A signal is received within 10 seconds after the last transmission, the received audio is also recorded. <ul style="list-style-type: none"> <li>- A signal is received within 10 seconds after the last reception.</li> </ul> </li> <li>• The squelch is open in the FM modes.</li> </ul> The recording will stop when: <ul style="list-style-type: none"> <li>• The frequency or operating mode is changed.</li> <li>• The operating method (V/M, M-CH, Band Stacking Register, and so on) is changed.</li> <li>• 10 minutes has past after the last transmission while the squelch is open in the SSB, CW, RTTY, PSK or AM modes.</li> </ul> </li> </ul>
<b>QSO PLAY Skip Time</b>	<b>10s</b>
Set the Skip time for forwarding or rewinding while playing back the QSO audio. 3, 5, 10 and 30 seconds are selectable.	

## ■ Saving a voice message into the USB flash drive

### ◇ Saving the received audio memory

The USB flash drive is not supplied by Icom.

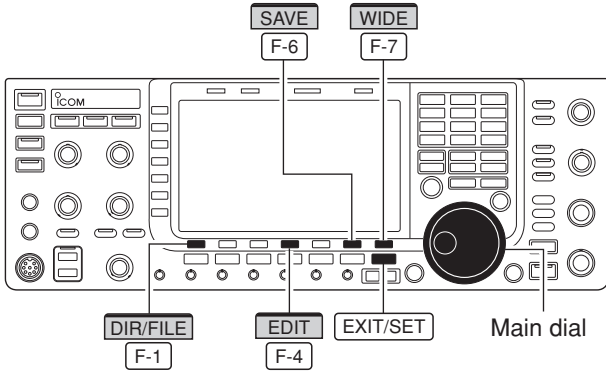

#### • Voice recorder RX memory screen



#### • Voice file save screen— file name edit

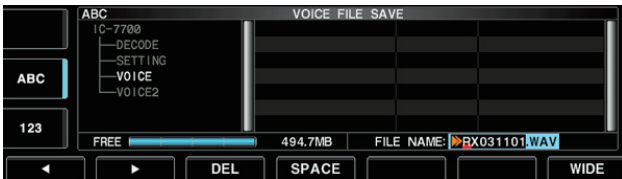

#### • While saving

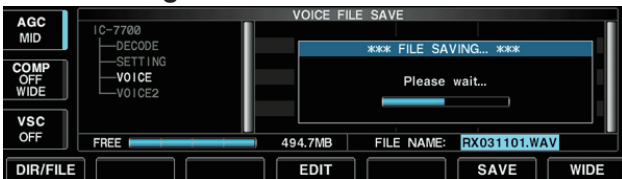

When a PC keyboard is connected to [USB] connector on the front panel, the file name can also be edited from the keyboard.

The recorded RX memory contents can be saved into the USB flash drive.

- During Voice recorder RX memory screen display, push [SAVE] [F-6] to select voice file save screen.
  - Previously selected screen, TX or RX memory, is displayed. If the TX message (T1–T4) appears, push [T/R] [F-7] to select RX message.
- Change the following conditions if desired.

#### • File name:

- Push [EDIT] [F-4] to select file name edit condition.
  - Push [DIR/FILE] [F-1] several times to select the file name, if necessary.
- Push [ABC] (MF6), [123] (MF7) or [Symbol] (MF7) to select the character group, then rotate the main dial to select the character.
  - [ABC] (MF6) : A to Z (capital letters); [123] (MF7): 0 to 9 (numerals); [Symbol] (MF7): ! # \$ % & ' ` ^ - ( ) { } \_ ~ @ can be selected.
- Push [Left] [F-1] to move the cursor left, push [Right] [F-2] to move the cursor right, push [DEL] [F-3] to delete a character and push [SPACE] [F-4] to insert a space.
- Push [EXIT/SET] to set the file name.

#### • Saving location

- Push [DIR/FILE] [F-1] to select tree view screen.
- Select the desired directory or folder in the USB flash drive.
  - Push [Left/Right] [F-4] to select the upper directory.
  - Push [Up] [F-2] or [Down] [F-3] to select folder in the same directory.
  - Hold down [Left/Right] [F-4] for 1 second to select a folder in the directory.
  - Push [REN/DEL] [F-5] to rename the folder.
  - Hold down [REN/DEL] [F-5] for 1 second to delete the folder.
  - Hold down [MAKE] [F-6] for 1 second to making a new folder. (Edit the name with the same manner as the “• File name” above.)
- Push [DIR/FILE] [F-1] twice to select the file name.



- Push [SAVE] [F-6].
  - After the saving is completed, return to voice recorder RX memory screen automatically.

### ◇ Saving the TX memory

The TX memory contents can also be saved into the USB flash drive. However, the contents are saved with the message list, set mode conditions, etc. at the same time. See page 12-24 for details.



---

■ Memory channels .....	8-2
■ Memory channel selection .....	8-2
◇ Using the  /  keys .....	8-2
◇ Using the keypad .....	8-2
■ Memory channel programming .....	8-3
◇ Programming in VFO mode .....	8-3
◇ Programming in memory mode .....	8-3
■ Frequency transfers .....	8-4
◇ Transferring in VFO mode .....	8-4
◇ Transferring in memory mode .....	8-4
■ Memory list screen .....	8-5
◇ Selecting a memory channel using the memory list screen .....	8-5
◇ Confirming programmed memory channels .....	8-5
■ Memory names .....	8-6
◇ Editing (programming) memory names .....	8-6
■ Memory clearing .....	8-6
■ Memo pads.....	8-7
◇ Writing frequencies and operating modes into memo pads .....	8-7
◇ Calling up a frequency from a memo pad .....	8-7

## Memory channels

The transceiver has 101 memory channels. Memory mode is very useful for quickly changing to often-used frequencies.

All 101 memory channels are tuneable which means the programmed frequency can be tuned temporarily with the main dial, etc. in memory mode.

MEMORY CHANNEL	MEMORY CHANNEL NUMBER	CAPABILITY	TRANSFER TO VFO	OVER-WRITING	CLEAR
Regular memory channels	1-99	Independent transmit and receive frequencies and modes in each memory channel.	Yes	Yes	Yes
Scan edge memory channels	P1, P2	One frequency and one mode in each memory channel as scan edges for programmed scan.	Yes	Yes	No

## Memory channel selection

### Using the ▲ / ▼ keys

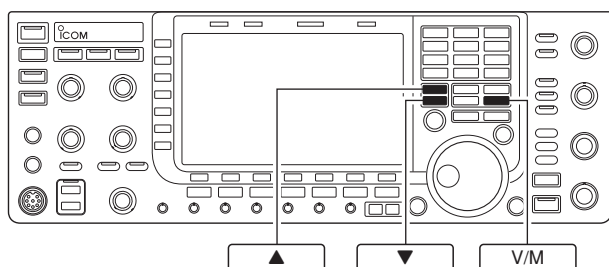

- ① Push **V/M** to select memory mode.
- ② Push **▲** / **▼** several times to select the desired memory channel.
  - Hold down **▲** / **▼** for continuous selection.
  - [UP] and [DN] on the microphone can also be used.
- ③ To return to VFO mode, push **V/M** again.

### Using the keypad

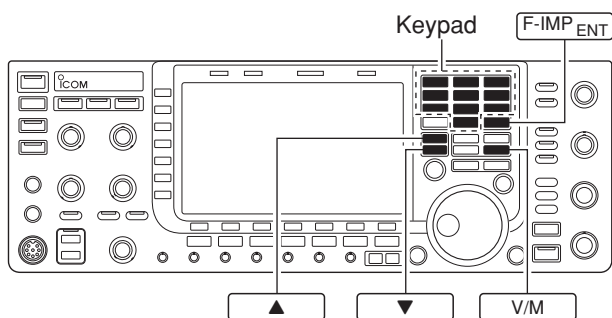

- ① Push **V/M** to select memory mode.
- ② Push **F-IMP ENT**.
- ③ Push the desired memory channel number using the keypad.
  - Enter 100 or 101 to select scan edge channel P1 or P2, respectively.
- ④ Push **▲** or **▼** to select the desired memory channel.

#### [EXAMPLE]

To select the memory channel 3;

- Push **F-IMP ENT**, **7** **3**, then push **▲** or **▼**.

To select the memory channel 12;

- Push **F-IMP ENT**, **1.8** **1**, **3.5** **2**, then push **▲** or **▼**.

To select the scan edge channel P1;

- Push **F-IMP ENT**, **1.8** **1**, **50** **0**, **50** **0**, then push **▲** or **▼**.

To select the scan edge channel P2;

- Push **F-IMP ENT**, **1.8** **1**, **50** **0**, **1.8** **1**, then push **▲** or **▼**.



## Memory channel programming

Memory channel programming can be performed either in VFO mode or in memory mode.

### ◇ Programming in VFO mode

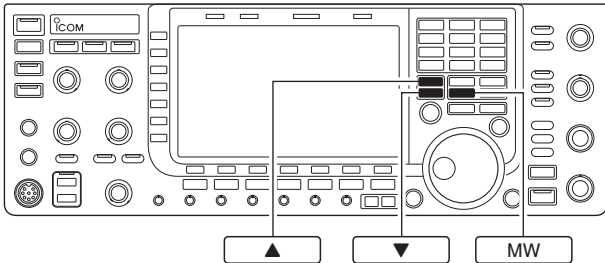

**[EXAMPLE]:**

Programming 7.088 MHz/LSB into memory channel 12.

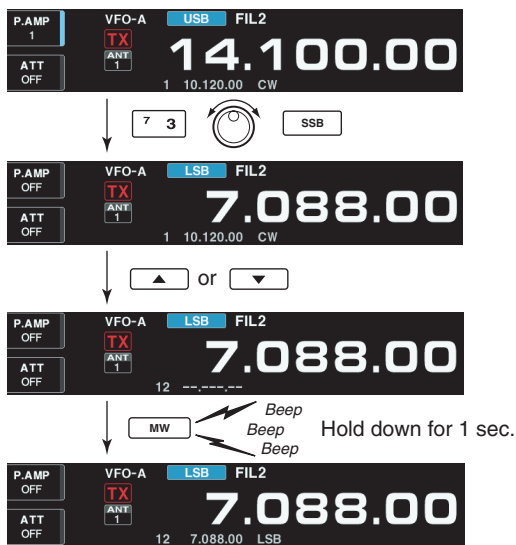

- ① Set the desired frequency, operating mode and filter width in VFO mode.
- ② Push / several times to select the desired memory channel.
  - Memory list screen is convenient for selecting the desired channel.
  - Memory channel contents appear in the memory channel readout (below the frequency readout).
  - “--.--” appears if the selected memory channel is a blank channel (and does not have contents).
- ③ Hold down for 1 second to program the displayed frequency, operating mode, etc., into the memory channel.

### ◇ Programming in memory mode

**[EXAMPLE]:**

Programming 21.280 MHz/USB into memory channel 18.

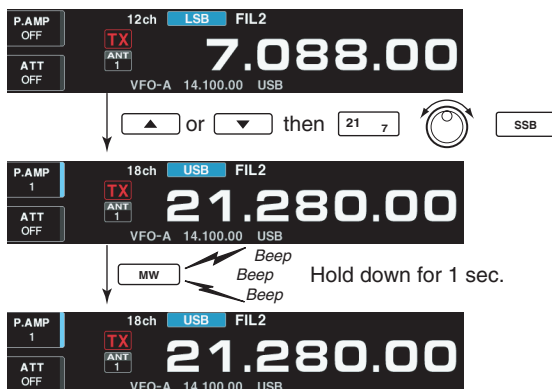

- ① Select the desired memory channel with / in memory mode.
  - Memory channel contents appear in the memory channel readout (below the frequency readout).
  - “--.--” appears if the selected memory channel is a blank channel (and does not have contents).
- ② Set the desired frequency and operating mode in memory mode.
  - To program a blank channel, use direct frequency entry with the keypad or memo pads, etc.
- ③ Hold down for 1 second to program the displayed frequency and operating mode into the memory channel.

## Frequency transfers

### ◇ Transferring in VFO mode

#### TRANSFER EXAMPLE IN VFO MODE

Operating frequency : 21.320 MHz/USB (VFO)  
 Contents of M-ch 16 : 14.018 MHz/CW

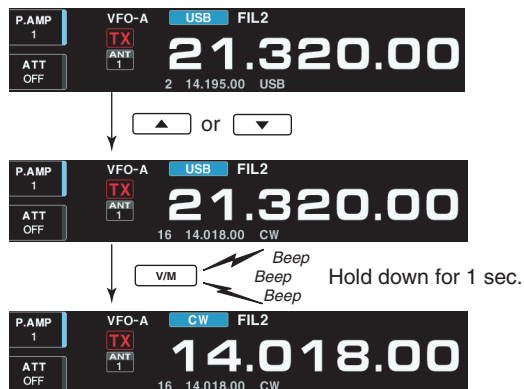

### ◇ Transferring in memory mode

#### TRANSFER EXAMPLE IN MEMORY MODE

VFO frequency : 21.320 MHz/USB  
 Contents of M-ch 16 : 14.018 MHz/CW

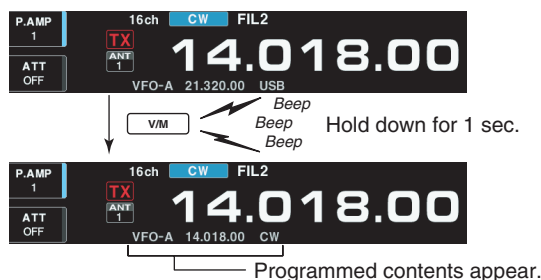

The frequency and operating mode in a memory channel can be transferred to the VFO. Frequency transfers can be performed in either VFO mode or memory mode.

This is useful for transferring programmed contents to a VFO.

- ① Select VFO mode with .
- ② Select the memory channel to be transferred with  / .

  - Memory list screen is convenient for selecting the desired channel.
  - Memory channel contents appear in the memory channel readout (below the frequency readout).
  - “---.---.---” appears if the selected memory channel is a blank channel. In this case transferring is not possible.

- ③ Hold down  for 1 second to transfer the frequency and operating mode.

  - Transferred frequency and operating mode appear on the frequency readout.

This is useful for transferring frequency and operating mode while operating in memory mode.

- ▨ When you have changed the frequency or operating mode in the selected memory channel:
  - **Displayed** frequency, mode and filter setting are transferred.
  - **Programmed** frequency and mode in the memory channel are not transferred, and they remain in the memory channel.

- ① Select the memory channel to be transferred with  /  in memory mode.
  - And, set the frequency or operating mode if required.
- ② Hold down  for 1 second to transfer the frequency and operating mode.
  - Displayed frequency and operating mode are transferred to the VFO.
- ③ To return to VFO mode, push  momentarily.

## Memory list screen

The memory list screen simultaneously shows 9 memory channels and their programmed contents. 15 memory channels can be displayed in the wide memory list screen.

You can select a desired memory channel from the memory list screen.

### ◇ Selecting a memory channel using the memory list screen

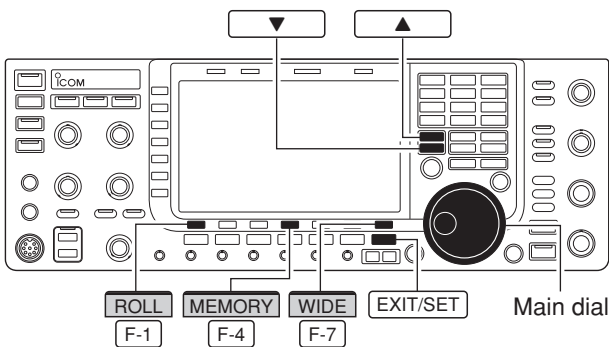

- ① Push [EXIT/SET] several times to close a multi-function screen, if necessary.
- ② Push [MEMORY] [F-4] to select memory list screen.
  - [WIDE] [F-7] switches the standard and wide screens.
- ③ While holding down [ROLL] [F-1], rotate the main dial to select the desired memory channel.
  - ▲ and ▼ can also be used.
- ④ Push [EXIT/SET] to exit memory list screen.

### • Memory list screen



### ◇ Confirming programmed memory channels

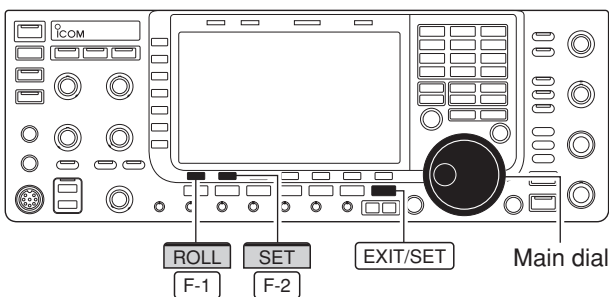

- ① Select memory list screen as described above.
- ② While pushing [ROLL] [F-1], rotate the main dial to scroll the screen.
- ③ Push [SET] [F-2] to select the highlighted memory channel, if desired.
  - “▶” appears beside the selected memory channel number in the memory list screen and the selected memory channel contents are displayed below the frequency readout.
- ④ Push [EXIT/SET] to exit memory list screen.

## Memory names

All memory channels (including scan edges) can be tagged with alphanumeric names of up to 10 characters each.

Capital letters, small letters, numerals, some symbols (! # \$ % & ¥ ? " ' ` ^ + - \* / . , ; = < > ( ) [ ] { } | \_ ~ @) and spaces can be used.

### Editing (programming) memory names

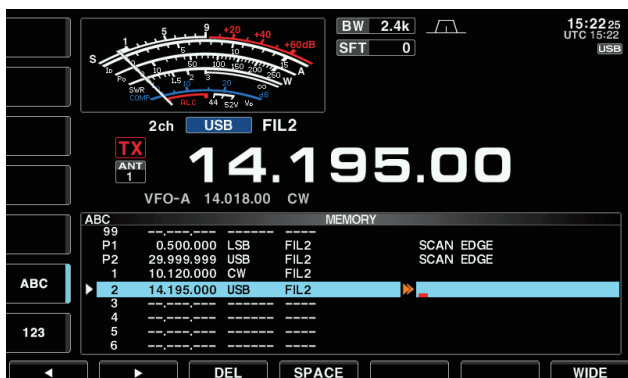
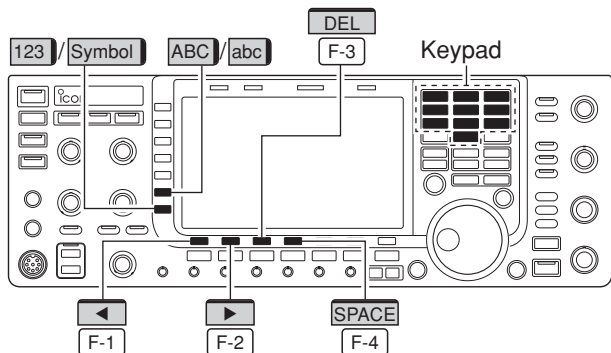

- 1 Push [EXIT/SET] several times to close a multi-function screen, if necessary.
- 2 Push [MEMORY] [F-4] to select memory list screen.
- 3 Select the desired memory channel.
- 4 Push [NAME] [F-4] to edit memory channel name.
  - A cursor appears and blinks.
  - Memory channel names of blank channels cannot be edited.
- 5 Input the desired character by rotating the main dial or by pushing the keypad for number input.
  - Push [ABC] or [abc] to toggle capital and small letters.
  - Push [123] or [Symbol] to toggle numerals and symbols.
  - Push [◀] [F-1] or [▶] [F-2] for cursor movement.
  - Push [DEL] [F-3] to delete the selected character.
  - Push [SPACE] [F-4] to input a space.
  - Pushing the transceiver's keypad, [0]–[9], can also enter numerals.
- 6 Push [EXIT/SET] to input and set the name.
  - The cursor disappears.
- 7 Repeat steps 3) to 6) to program another memory channel's name, if desired.
- 8 Push [EXIT/SET] to exit memory list screen.

#### ✓ For your convenience

When a PC keyboard is connected to [USB] connector on the front panel, the memory name can also be edited from the keyboard.

## Memory clearing

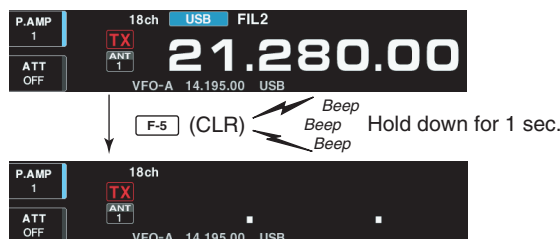
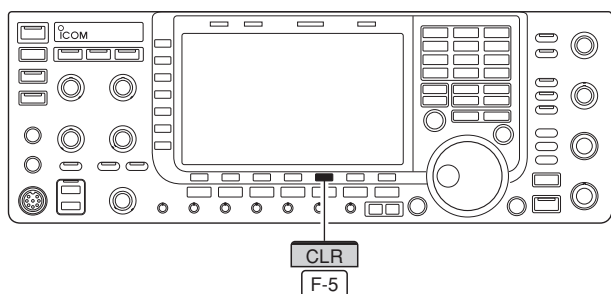

Any unused memory channels can be cleared. The cleared memory channels become blank channels.

- 1 Select memory mode with [V/M].
- 2 Push [MEMORY] [F-4] to select memory list screen.
- 3 Select the desired memory channel with [▲] / [▼].
- 4 Hold down [CLR] [F-5] for 1 second to clear the contents.
  - The programmed frequency and operating mode disappear.
- 5 To clear other memory channels, repeat steps 3) and 4).

## ■ Memo pads

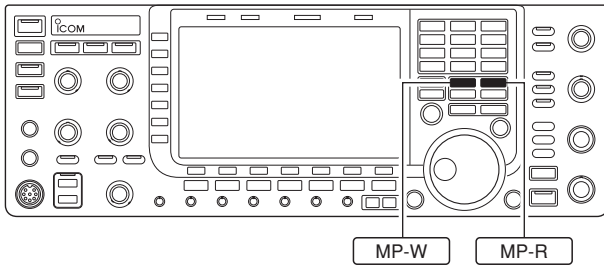

The transceiver has a memo pad function to store frequency and operating mode for easy write and recall. The memo pads are separate from memory channels.

The default number of memo pads is 5, however, this can be increased to 10 in set mode if desired. (p. 12-15)

Memo pads are convenient when you want to memorize a frequency and operating mode temporarily, such as when you find a DX station in a pile-up, or when a desired station is busy for a long time and you want to temporarily search for other stations.

Use the transceiver's memo pads instead of relying on hastily scribbled notes that are easily misplaced.

### ◇ Writing frequencies and operating modes into memo pads

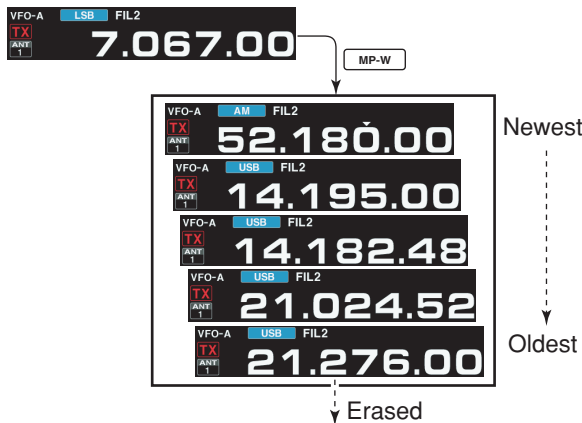

In this example, 21.276 MHz (USB) will be erased when 7.067 MHz (LSB) is written.

You can store the readout frequency and operating mode by pushing **MP-W**.

When you store a 6th frequency and operating mode, the oldest stored frequency and operating mode are automatically erased to make room for the new settings.

Each memo pad must have its own unique combination of frequency and operating mode; memo pads having identical settings cannot be written.

### ◇ Calling up a frequency from a memo pad

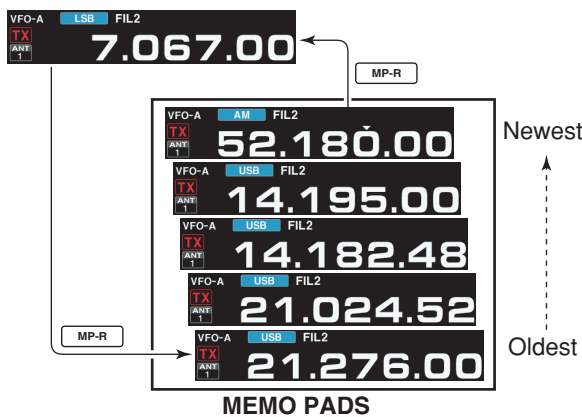

You can call up the desired frequency and operating mode of a memo pad by pushing **MP-R** several times.

- Both VFO and memory modes can be used.
- The frequency and operating mode are called up, starting from the most recently written.

When you call up a frequency and an operating mode from memo pads with **MP-R**, the previously displayed frequency and operating mode are automatically stored in a temporary pad. The frequency and operating mode in the temporary pad can be recalled by pushing **MP-R** several times.

- You may think there are 6 memo pads because 6 different frequencies (5 are in memo pads and 1 is in the temporary pad) are called up by **MP-R**.

If you change the frequency or operating mode called up from a memo pad with the main dial, etc., the frequency and operating mode in the temporary pad are erased.



- Scan types ..... 9-2
- Preparation ..... 9-2
- Voice squelch control function ..... 9-3
- Scan set mode ..... 9-3
- Programmed scan operation ..... 9-4
- $\Delta F$  scan operation ..... 9-4
- Fine programmed scan/Fine  $\Delta F$  scan ..... 9-5
- Memory scan operation ..... 9-6
- Select memory scan operation ..... 9-6
- Setting select memory channels ..... 9-7
  - ◇ Setting in scan screen ..... 9-7
  - ◇ Setting in memory list screen ..... 9-7
  - ◇ Erasing the select scan setting ..... 9-7
- Tone scan ..... 9-8

## ■ Scan types

### PROGRAMMED SCAN

Repeatedly scans between two scan edge frequencies (scan edge memory channels P1 and P2).

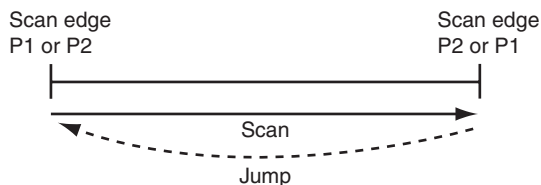

This scan operates in VFO mode.

### ΔF SCAN

Repeatedly scans within ΔF span area.

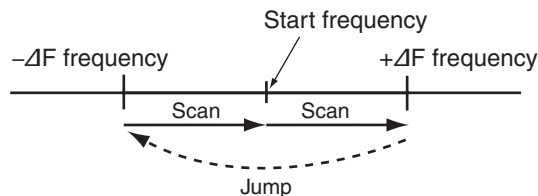

This scan operates in both VFO and memory modes.

### MEMORY SCAN

Repeatedly scans all programmed memory channels.

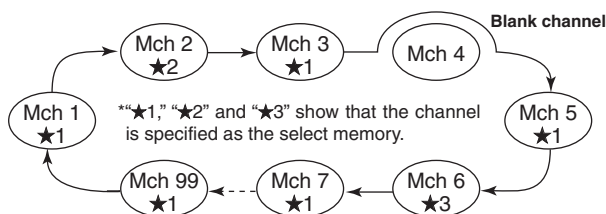

This scan operates in memory mode.

### SELECT MEMORY SCAN

Repeatedly scans all or one of 3 select memory channels.

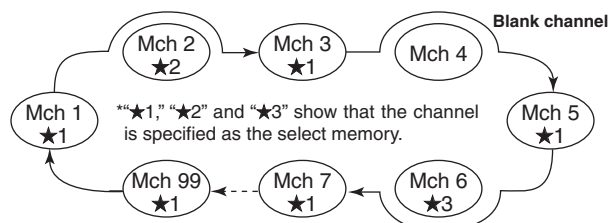

This scan operates in memory mode.

## ■ Preparation

### • Channels

*For programmed scan:*

Program scan edge frequencies into scan edge memory channels P1 and P2.

*For ΔF scan:*

Set the ΔF span (ΔF scan range) in the scan screen.

*For memory scan:*

Program 2 or more memory channels except scan edge memory channels.

*For select memory scan:*

Designate 2 or more memory channels as select memory channels. To designate the channel as a select memory channel, choose a memory channel, then push [SELECT] [F-3] in the scan screen (memory mode) or in the memory list screen.

### • Scan resume ON/OFF

You can select the scan to resume or cancel when detecting a signal in set mode. Scan resume ON/OFF must be set before performing a scan. See page 9-3 for ON/OFF setting and scan resume condition details.

### • Scan speed

Scan speed can be selected from 2 levels, high or low, in scan set mode. See page 9-3 for details.

- The scan function can be used on the main read-out only.
- You can perform a scan while operating on a frequency using the split functions.

### • Squelch condition

#### ○ Scan starts with squelch open

**For programmed scan:**

*When tuning step is 1 kHz or less:*

The scan continues until it is stopped manually— it does not pause\* even if signals are detected.

\* The scan is paused when the squelch is closed and then opened (scan resumes after 10 seconds has passed when the scan resume is ON; scan is cancelled when the scan resume is OFF).

*When tuning step is more than 5 kHz:*

The scan pauses on each step when the scan resume is ON; not applicable when the scan resume is OFF.

**For memory scan:**

Scan pauses on each channel when the scan resume is ON; not applicable when the scan resume is OFF.

#### ○ Scan starts with squelch closed

Scan stops when a signal is detected.

- If the scan resume is set to ON in scan set mode, the scan pauses for 10 seconds when detecting a signal, then resumes. When a signal disappears while scan is paused, scan resumes 2 seconds later.



## ■ Voice squelch control function

This function is useful when you don't want unmodulated signals pausing or cancelling a scan. When the voice squelch control function is activated, the transceiver checks received signals for voice components.

If a received signal includes voice components, and the tone of the voice components changes within 1 second, scan pauses (or stops). If the received signal includes no voice components or the tone of the voice components does not change within 1 second, scan resumes.

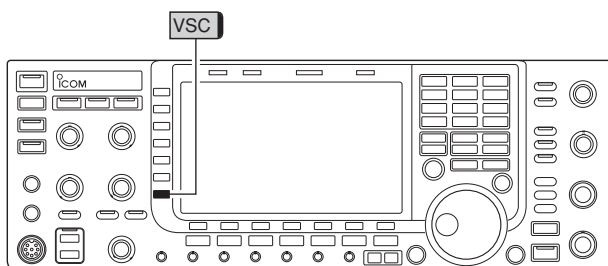

- ➔ While a phone mode (SSB, AM or FM) is selected, push [VSC] (MF7) to switch the VSC (Voice Squelch Control) function ON and OFF.
  - "VSC" appears when the function is activated.

- ▨ • The VSC function activates for any scan.
- ▨ • The VSC function resumes the scan on unmodulated signals, regardless of whether the scan resume condition is set to ON or OFF.

## ■ Scan set mode

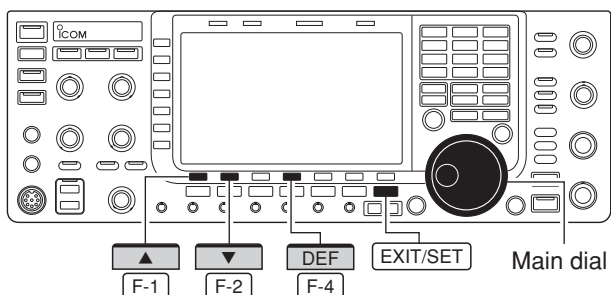

When the squelch is open, scan continues until it is stopped manually—it does not pause on detected signals. When squelch is closed, scan stops when detecting a signal, then resumes according to the scan resume condition. Scan speed and the scan resume condition can be set using the scan set mode.

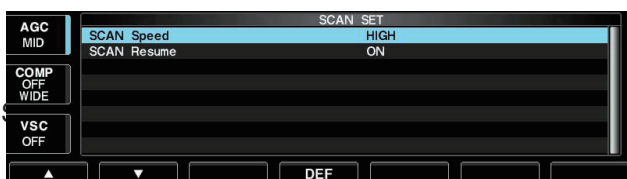

- ① Push [SCAN] [F-5] to select scan screen.
- ② Push [SET] [F-7] to select scan set mode.
- ③ Push [▲] [F-1] or [▼] [F-2] to select the desired item.
- ④ Rotate the main dial to select the desired condition.
  - Hold down [DEF] [F-4] for 1 second to select the default setting.
- ⑤ Push [EXIT/SET] to return to scan menu.

<b>Scan Speed</b>	<b>HIGH</b>
	<ul style="list-style-type: none"> <li>• HIGH : scan is faster</li> <li>• LOW : scan is slower</li> </ul>
<b>Scan Resume</b>	<b>ON</b>
Set the scan resume function ON or OFF.	<ul style="list-style-type: none"> <li>• ON : When detecting a signal, scan pauses for 10 seconds, then resumes. When a signal disappears, scan resumes 2 seconds later.</li> <li>• OFF : When detecting a signal, cancels scanning.</li> </ul>

## Programmed scan operation

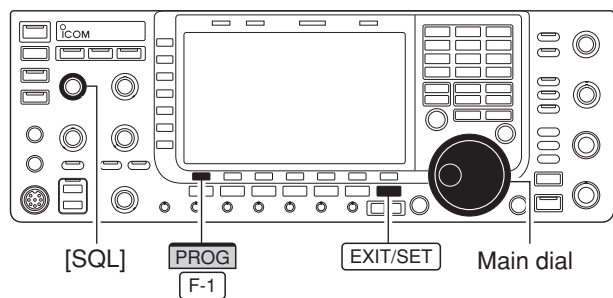

- ① Push [EXIT/SET] several times to close a multi-function screen, if necessary.
- ② Select VFO mode.
- ③ Select the desired operating mode.
  - The operating mode can also be changed while scanning.
- ④ Push [SCAN] [F-5] to select the scan screen.
- ⑤ Set [SQL] open or closed.
  - See page 9-2 for squelch condition.
- ⑥ Push [PROG] [F-1] to start the programmed scan.
  - “PROGRAM SCAN” and decimal points blink while scanning.
- ⑦ When the scan detects a signal, scan stops, pauses or ignores it depending on the resume setting and the squelch status.
- ⑧ To cancel the scan, push [PROG] [F-1].
  - Rotating the main dial also cancels the scan.
- ⑨ Hold down [RECALL] [F-6] for 1 second to recall the frequency that is set before starting the scan, if desired.

⚡ If the same frequencies are programmed into the scan edge memory channel P1 and P2, programmed scan will not start.

## ΔF scan operation

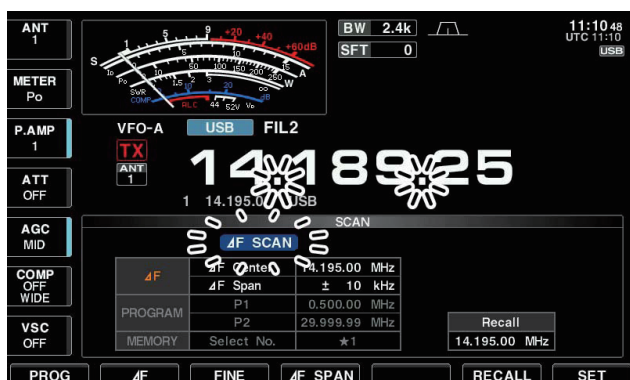
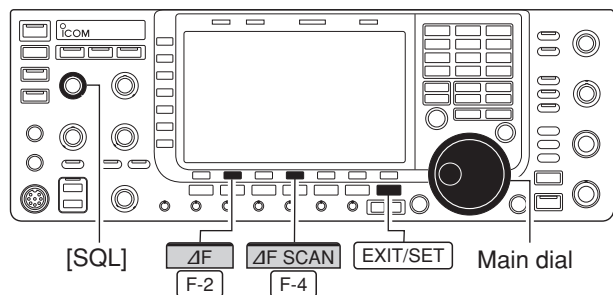

- ① Push [EXIT/SET] several times to close a multi-function screen, if necessary.
- ② Select VFO mode or a memory channel.
- ③ Select the desired operating mode.
  - The operating mode can also be changed while scanning.
- ④ Push [SCAN] [F-5] to select the scan screen.
- ⑤ Set the main band's [SQL] open or closed.
  - See page 9-2 for squelch condition.
- ⑥ Set the ΔF span by pushing [ΔF SPAN] [F-4].
  - ±5 kHz, ±10 kHz, ±20 kHz, ±50 kHz, ±100 kHz, ±500 kHz and ±1000 kHz are selectable.
- ⑦ Set center frequency of the ΔF span.
- ⑧ Push [ΔF] [F-2] to start the ΔF scan.
  - “ΔF SCAN” and decimal points blink while scanning.
- ⑨ When the scan detects a signal, the scan stops, pauses or ignores it depending on the resume setting and the squelch status.
- ⑩ To cancel the scan, push [ΔF] [F-2].
  - Rotating the main dial also cancels the scan.
- ⑪ Hold down [RECALL] [F-6] for 1 second to recall the frequency that was set before starting the scan.

## ■ Fine programmed scan/Fine $\Delta F$ scan

In fine scan (programmed or  $\Delta F$ ), the scan speed decreases when the squelch opens, but the transceiver keeps scanning. The scanning tuning step shifts from 50 Hz to 10 Hz when the squelch opens.

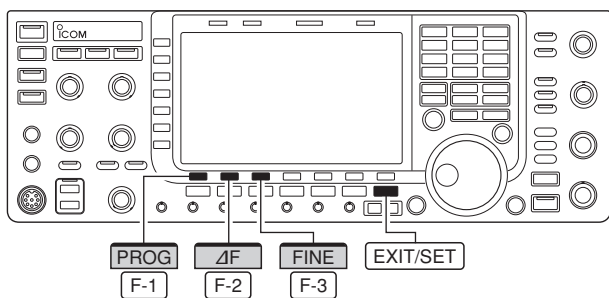

- ① Push [EXIT/SET] several times to close a multi-function screen, if necessary.
- ② Push [SCAN] [F-5] to select the scan screen.
- ③ Set for programmed scan or  $\Delta F$  scan as described on previous page.
- ④ Push [PROG] [F-1] or [ $\Delta F$ ] [F-2] to start a scan.
  - “PROGRAM SCAN” or “ $\Delta F$  SCAN” and decimal points blink while scanning.
- ⑤ Push [FINE] [F-3] to start a fine scan.
  - “FINE PROGRAM SCAN” or “FINE  $\Delta F$  SCAN” blinks instead of “PROGRAM SCAN” or “ $\Delta F$  SCAN,” respectively.
- ⑥ When the scan detects a signal, the scan speed decreases but scan does not stop.
- ⑦ Push [PROG] [F-1] or [ $\Delta F$ ] [F-2] to stop the scan; push [FINE] [F-3] to cancel the fine scan.
  - Rotating the main dial also cancels the scan.
- ⑧ Hold down [RECALL] [F-6] for 1 second to recall the frequency that is set before starting the scan, if desired.

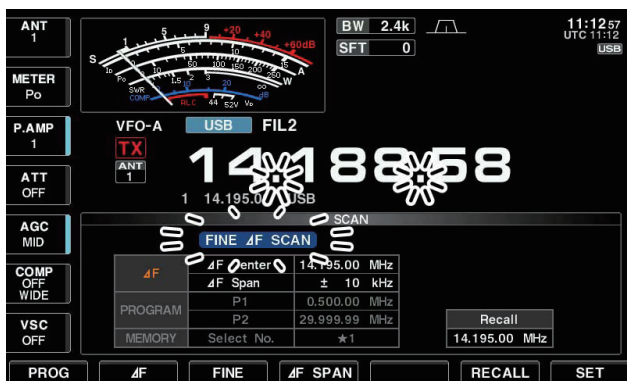

## Memory scan operation

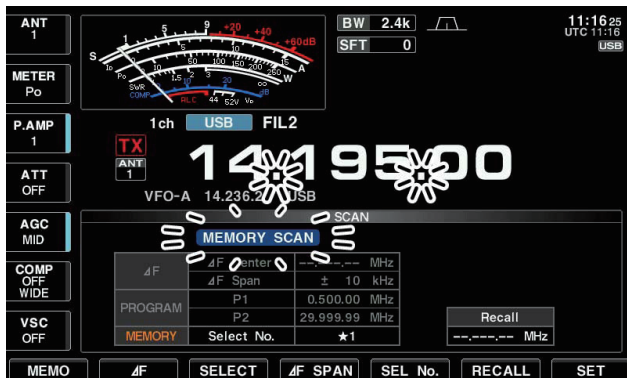
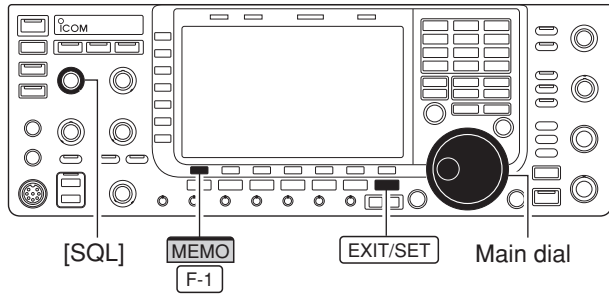

- ① Push [EXIT/SET] several times to close a multi-function screen, if necessary.
- ② Select memory mode.
- ③ Push [SCAN] [F-5] to select the scan screen.
- ④ Set [SQL] open or closed.
  - See page 9-2 for squelch condition.
- ⑤ Push [MEMO] [F-1] to start the memory scan.
  - “MEMORY SCAN” and decimal points blink while scanning.
- ⑥ When the scan detects a signal, the scan stops, pauses or ignores it depending on the resume setting and the squelch condition.
- ⑦ To cancel the scan, push [MEMO] [F-1].
  - Rotating the main dial also cancels the scan.

2 or more memory channels must be programmed for memory scan to start.

## Select memory scan operation

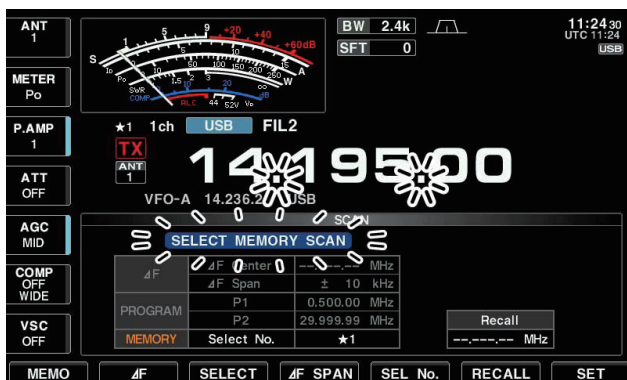
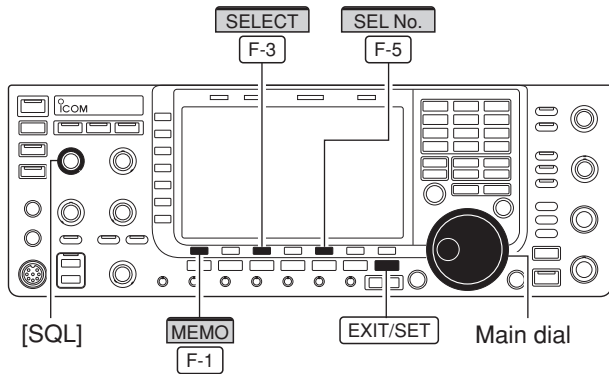

- ① Push [EXIT/SET] several times to close a multi-function screen, if necessary.
- ② Select memory mode.
- ③ Push [SCAN] [F-5] to select the scan screen.
- ④ Set [SQL] open or closed.
  - See page 9-2 for squelch condition.
- ⑤ Push [SEL No.] [F-5] several times to select the select scan number from ★1, ★2, ★3 and ★1,2,3.
- ⑥ Push [MEMO] [F-1] to start the memory scan.
  - “MEMORY SCAN” and decimal points blink while scanning.
- ⑦ Push [SELECT] [F-3] to start select memory scan; push [SELECT] [F-3] again to return to memory scan, if desired.
  - “SELECT MEMORY SCAN” blinks instead of “MEMORY SCAN” during select memory scan.
- ⑧ When the scan detects a signal, the scan stops, pauses or ignores it depending on the resume setting and the squelch condition.
- ⑨ To cancel the scan, push [MEMO] [F-1].
  - Rotating the main dial also cancels the scan.

2 or more memory channels must be designated as select memory channels, as well as the same select scan channel number, for select memory scan to start.

## ■ Setting select memory channels

### ◇ Setting in scan screen

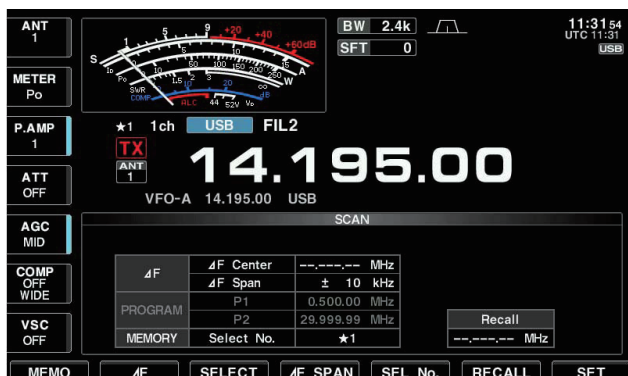

- ① Push [EXIT/SET] several times to close a multi-function screen, if necessary.
- ② Select memory mode.
- ③ Push [SCAN] [F-5] to select the scan screen.
- ④ Select the desired memory channel to set as a select memory channel.
  - [▲] / [▼] keys and direct keypad selections can be used.
- ⑤ Push [SELECT] [F-3] several times to set the memory channel as a select memory ★1, ★2, ★3 or not.
- ⑥ Repeat steps ④ to ⑤ to program another memory channel as a select memory channel.
- ⑦ Push [EXIT/SET] to exit the scan screen.

### ◇ Setting in memory list screen

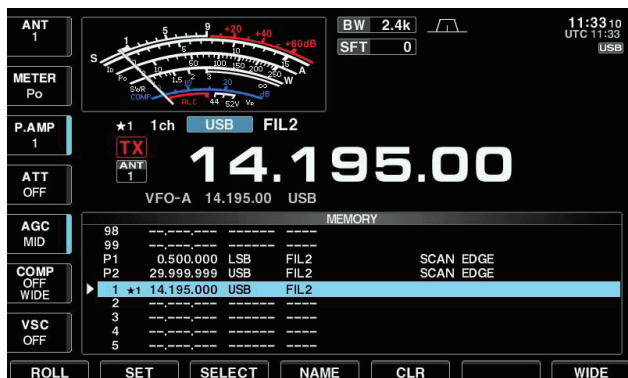

- ① Push [EXIT/SET] several times to close a multi-function screen, if necessary.
- ② Push [MEMORY] [F-4] to select memory list screen.
- ③ Rotate the main dial while pushing [ROLL] [F-1] or [SET] [F-2] to select the desired memory channel.
  - [▲] / [▼] keys and direct keypad selections can be used.
- ④ Push [SELECT] [F-3] several times to set the memory channel as a select memory ★1, ★2, ★3 or not.
- ⑤ Repeat steps ③ to ④ to program another memory channel as a select memory channel.
- ⑥ Push [EXIT/SET] to exit the memory list screen.

### ◇ Erasing the select scan setting

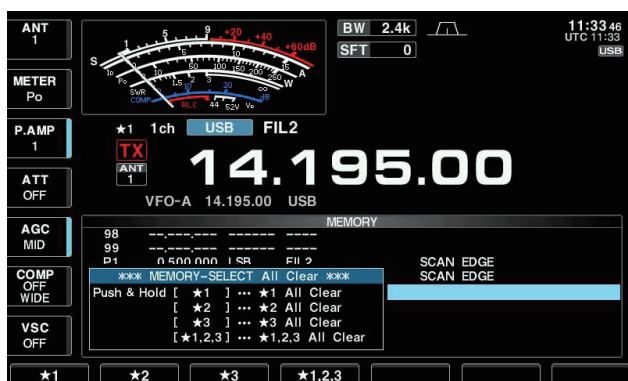

- ① Push [EXIT/SET] several times to close a multi-function screen, if necessary.
- ② Push [MEMORY] [F-4] to select memory list screen, or push [SCAN] [F-5] to select scan screen.
- ③ Hold down [SELECT] [F-3] for 1 second to display memory select all clear window.
- ④ Push one of the following keys to clear all select scan setting.
  - [★1] [F-1] : Clears all ★1 setting.
  - [★2] [F-2] : Clears all ★2 setting.
  - [★3] [F-3] : Clears all ★3 setting.
  - [★1,2,3] [F-4] : Clears all select setting.
- ⑤ Push [EXIT/SET] to exit the memory list screen.

## ■ Tone scan

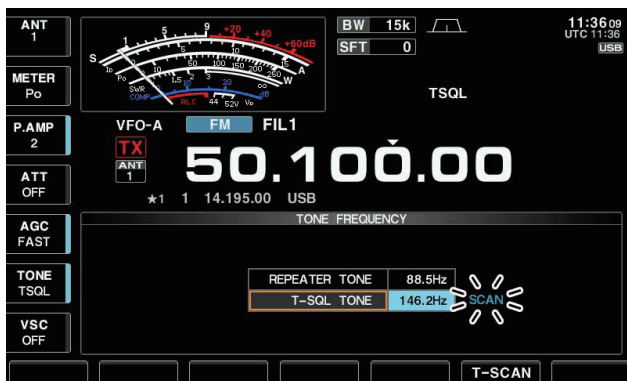
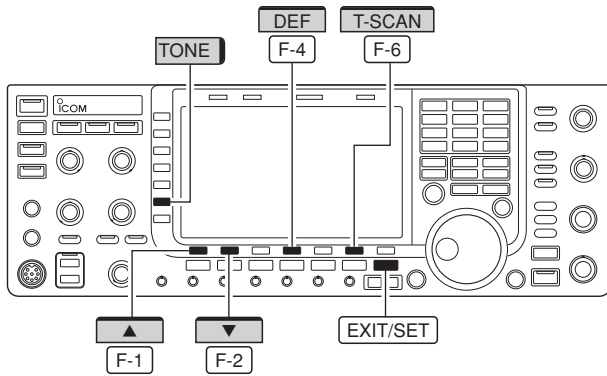

The transceiver can detect subaudible tones in a received signal. By monitoring a signal that is being transmitted on a repeater input frequency, you can determine the tone frequency required to access the repeater.

- ① Set the desired frequency or memory channel to be checked for a tone frequency.
- ② Push **[AM/FM]** several times to select FM mode.
- ③ Hold down **[TONE]** (MF6) for 1 second to enter tone frequency screen.
- ④ Push **[▲]** **[F-1]** or **[▼]** **[F-2]** to check the repeater tone frequency or tone squelch frequency, respectively.
- ⑤ Push **[T-SCAN]** **[F-6]** to start the tone scan.
  - "SCAN" blinks while scanning.
- ⑥ When a matching tone frequency is detected, the tone scan pauses.
  - The tone frequency is set temporarily on a memory channel. Program the memory channel to store the tone frequency permanently.
  - The decoded tone frequency is used for the repeater tone frequency or tone squelch frequency.
- ⑦ To stop the scan, push **[T-SCAN]** **[F-6]**.
  - Hold down **[DEF]** **[F-4]** for 1 second to select the default frequency.
- ⑧ Push **[EXIT/SET]** to exit tone frequency screen.

■ Antenna connection and selection .....	10-2
■ Antenna memory settings .....	10-3
◇ Antenna type selection .....	10-3
◇ Temporary memory .....	10-4
◇ Antenna selection mode .....	10-4
◇ Receive antenna I/O setting .....	10-5
■ Antenna tuner operation .....	10-6
◇ Tuner operation .....	10-6
◇ If the tuner cannot tune the antenna .....	10-7

## ■ Antenna connection and selection

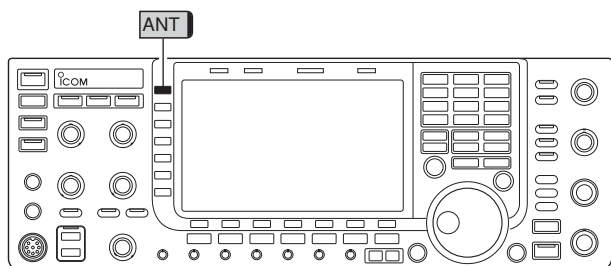

The IC-7700 has 4 antenna connectors for the HF/50 MHz bands, [ANT1], [ANT2], [ANT3], and [ANT4].

For each operating band the IC-7700 covers, there is a band memory which memorizes the selected antenna. When you change the operating frequency outside of a band, the previously used antenna is automatically selected (see below) for the new band. This function allows automatic switching of 4 separate antennas for HF and 50 MHz bands operation.

### • Antenna selection mode: “Auto”

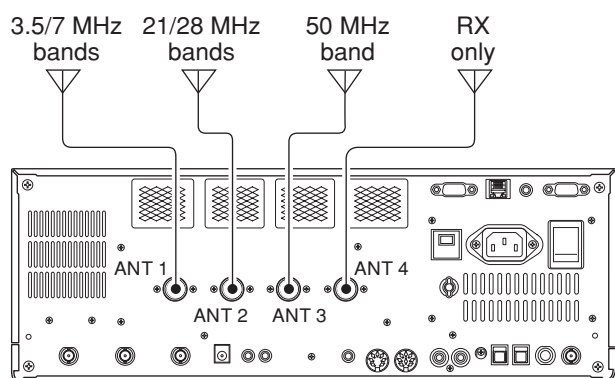

After an antenna has been selected for use (by pushing [ANT] (MF1)), the antenna is automatically selected whenever that band is used.

**[EXAMPLE]:** a 3.5/7 MHz antenna is connected to [ANT1], a 21/28 MHz antenna is connected to [ANT2], a 50 MHz antenna is connected to [ANT3]. When the antenna selector function is set to “Auto,” an antenna is automatically selected when changing bands. A receive-only antenna can be specified for [ANT4].

### • Antenna selection mode: “Manual”

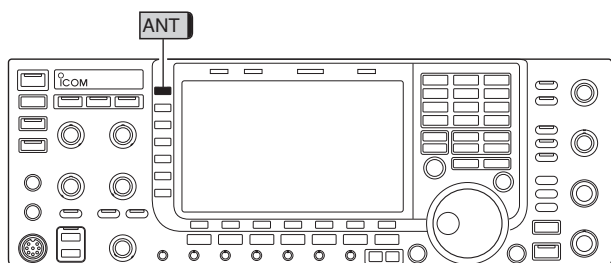

When “Manual” is selected, you can use the all antenna connectors, [ANT1] [ANT2], [ANT3] and [ANT4], however, band memory does not function. In this case you must select an antenna manually.

### • Antenna selection mode: “OFF”

In this case, only [ANT1] antenna connector can be used. [ANT] (MF1) switch does not function.



## ■ Antenna memory settings

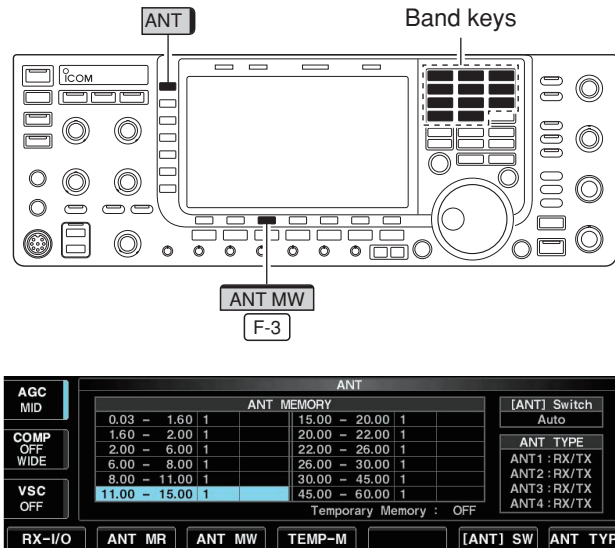

This function stores the antenna connector number for each frequency band.

- ① Push [EXIT/SET] several times to close multi-function screen, if necessary.
- ② Hold down [ANT] (MF1) for 1 second to select antenna set screen.
- ③ Select the desired frequency band with a band key.
- ④ Push [ANT] (MF1) several times to select the desired antenna number that you want to set for the selected frequency band.
  - “★” appears.
- ⑤ Hold down [ANT MW] [F-3] for 1 second to store the antenna selection into the antenna memory.
  - “★” disappears.
- ⑥ Repeat the steps ③ to ⑤ to store the antenna selection for another frequency bands, if desired.
- ⑦ Push [EXIT/SET] to exit antenna set screen.

## ◇ Antenna type selection

When no antenna is connected to [ANT2], [ANT3], and/or [ANT4], these antenna connectors can be deactivated — deleting the antenna number from the available selections. This prevents the transceiver from accidentally transmitting into an unused antenna connector. In addition, a receive-only antenna can be specified for [ANT4].

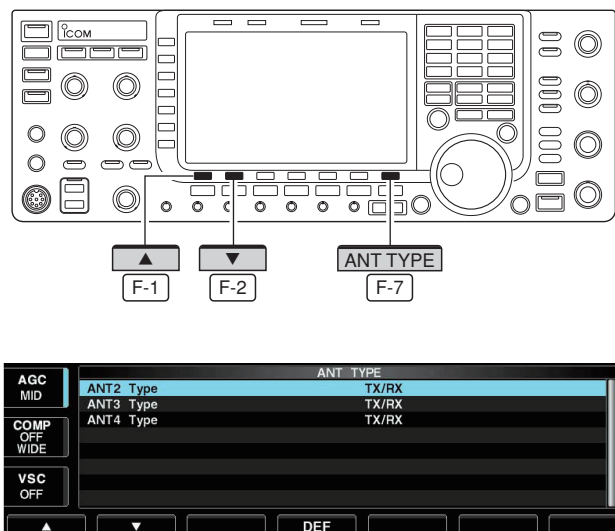

- ① Select the antenna set screen as described above.
- ② Push [ANT TYPE] [F-7] to select antenna type set screen.
- ③ Push [▲] [F-1] or [▼] [F-2] to select the desired antenna.
- ④ Rotate the main dial to select the desired antenna condition from TX/RX, RX (ANT4 only) and OFF.
  - TX/RX : Select when an antenna is connected.
  - OFF : Select when no antenna is connected.
  - RX : Select when a receive only antenna is connected. (available for the [ANT4] only)
- ⑤ Push [EXIT/SET] to exit antenna type set screen.

### ✓ For your information

The “OFF” antennas cannot be selected with [ANT] (MF1) switch operation, or with the antenna memory setting.

When “RX” is selected for [ANT4], “1/R,” “2/R” and “3/R” selections will be added for the selection for both [ANT] (MF1) switch operation and the antenna memory setting. In these selections, the antenna connected to [ANT1], [ANT2] and/or [ANT3] will be used for transmission and the antenna connected to [ANT4] will be used for reception.

## ■ Antenna memory settings (continued)

### ◇ Temporary memory

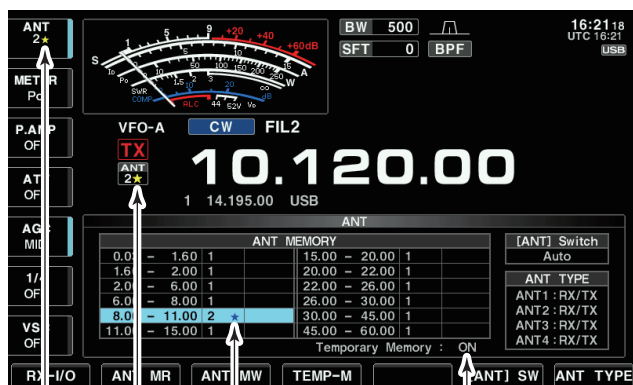

“★” indicators appear when a different antenna from the original is selected.

Push [TEMP-M] [F-4] to turn the temporary memory ON or OFF.

The antenna temporary memory memorizes the manually selected antenna. The selected antenna will be re-called even if frequency band has been changed.

- ① Select the antenna set screen.
- ② Push [TEMP-M] [F-4] to turn the temporary memory ON or OFF.
- ③ Select the desired frequency band with a band key.
- ④ Push [ANT] (MF1) to select the desired antenna.
  - “★” appears when a different antenna from the original is selected.
- ⑤ Push [ANT MR] [F-2] to re-call the original antenna.
  - “★” disappears.
- ⑥ Push [EXIT/SET] to exit antenna set screen.

**CAUTION:** Before transmitting with the manually selected antenna, make sure the selected antenna is suitable for the operating frequency. Otherwise the transceiver may be damaged.

### ◇ Antenna selection mode

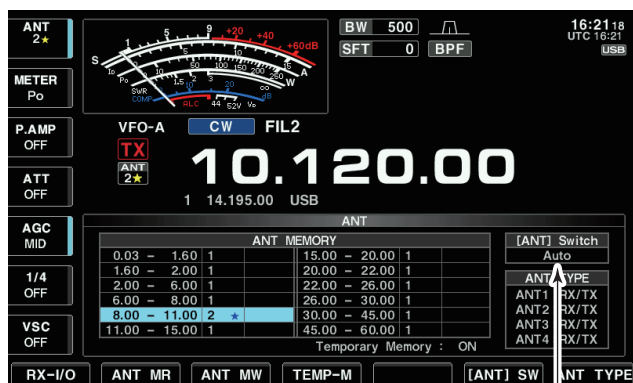

Push [ANT SW] [F-6] to select the antenna selection mode.

The automatic antenna selection (antenna memory) and the [ANT] (MF1) switch function can be deactivated if desired.

- ① Select the antenna set screen.
- ② Push [[ANT] SW] [F-6] to select the antenna selection from Auto, OFF and Manual.
  - Auto : Use the antenna memory. Antenna selection with [ANT] switch is also available.
  - OFF : Only the antenna connected to [ANT1] can be used. [ANT] switch is deactivated.
  - Manual: Deactivate the antenna memory function. Antenna can be selected with [ANT] switch operation only.
- ③ Push [EXIT/SET] to exit antenna set screen.

◇ Receive antenna I/O setting

In the default setting, receive antenna connectors, [RX ANT-IN] and [RX ANT-OUT], on the rear panel are deactivated and are connected internally by the switching relay. If you want to connect an external preamp or low-pass filter between the [RX ANT-IN] and [RX ANT-OUT], you must activate them as described below.

- ① Select the antenna set screen.
- ② Select the desired frequency band with a band key.
- ③ Push [RX-I/O] [F-1] to activate the receive antenna connectors ([RX ANT-IN] and [RX ANT-OUT]).
  - “RX-I/O” indicators appear when [RX ANT-IN] and [RX ANT-OUT] are active.
- ④ Repeat steps ② and ③, if desired.
- ⑤ Push [EXIT/SET] to exit antenna set screen.

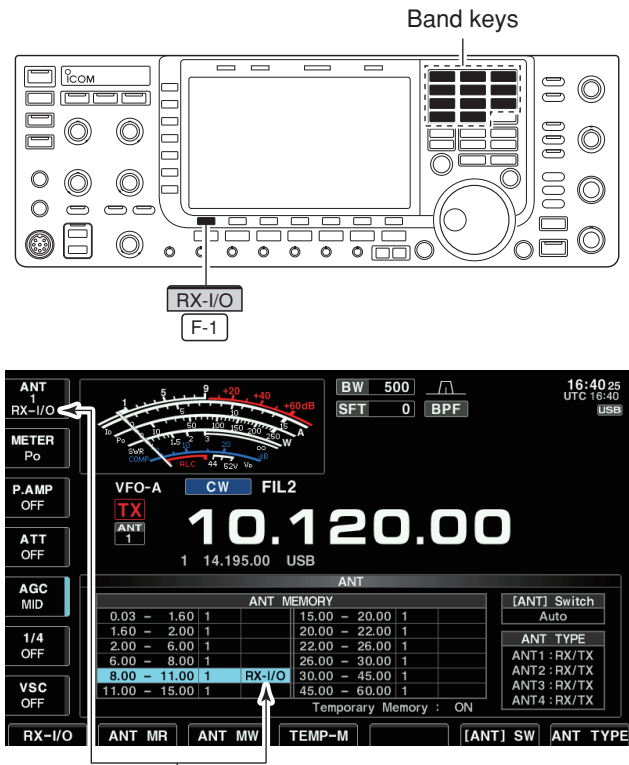

“RX-I/O” indicators appear when [RX ANT-IN] and [RX ANT-OUT] are active.

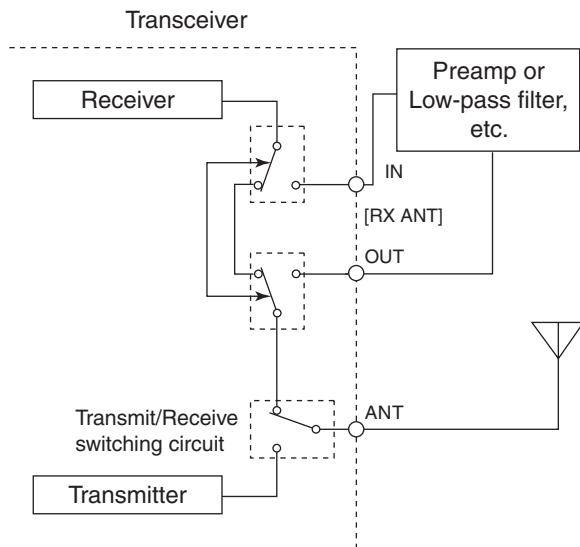

## ■ Antenna tuner operation

### ◇ Tuner operation

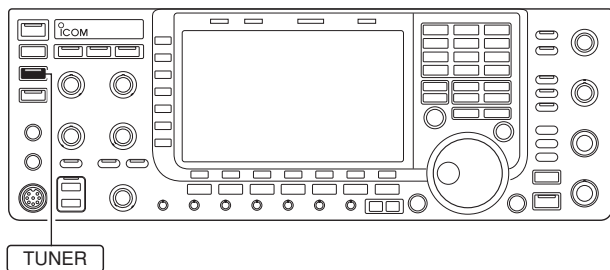

The internal automatic antenna tuner matches the transceiver to the connected antenna automatically. After the tuner matches an antenna, the variable capacitor settings are memorized as a preset point for each frequency range (100 kHz steps). Therefore, when you change the frequency range, the variable capacitors are automatically preset to the memorized setting.

**CAUTION: NEVER** transmit with the tuner ON when no antenna is connected. This will damage the transceiver. Be careful of the antenna selection.

- ➔ Push **[TUNER]** to turn the internal antenna tuner ON. The antenna is tuned automatically when the antenna SWR is higher than 1.5:1.
  - When the tuner is ON, **[TUNER]** switch indicator lights green.
  - While tuning, **[TUNER]** switch indicator blinks green.

**NOTES:**

- **NEVER** transmit without an antenna properly connected to antenna port in use.
- When 2 or more antennas are connected, select the antenna to be used with **[ANT]**.
- If the SWR is higher than about 1.5:1 when tuning farther than 100 kHz from an antenna's programmed preset point, hold down **[TUNER]** for 1 second to start manual tuning.
- The internal tuner may not be able to tune in AM mode. In such cases, hold down **[TUNER]** for 1 second to manually tune.

#### • MANUAL TUNING

During SSB operation at low voice levels, the internal tuner may not automatically tune correctly. In such cases, manual tuning is helpful.

- ➔ Hold down **[TUNER]** for 1 second, to start manual tuning.
  - A side tone is emitted and **[TUNER]** switch indicator blinks red while tuning.
  - If the tuner cannot reduce the SWR to less than 1.5:1 after 20 seconds of tuning, the **[TUNER]** switch indicator goes out.

#### • AUTOMATIC TUNER START (HF bands only)

If you want to deactivate the tuner under conditions of VSWR 1.5:1 or less, use the auto tuner start function and turn the tuner OFF. This function activates the tuner automatically when the SWR exceeds 1.5:1.

This function is controlled in set mode. (p. 12-13).

## ■ Antenna tuner operation (continued)

### • PTT TUNER START

The tuner is always re-tuned when the PTT is pushed after the frequency is changed (more than 1% from last-tuned frequency). This function replaces the “hold down [TUNER]” operation and activates for the first transmission on a new frequency.

This function is controlled in set mode. (p. 12-14).

### • Antenna tuner of the IC-PW1

When using an external antenna tuner such as the IC-PW1's tuner, tune with the external antenna tuner, and turn OFF the IC-7700's tuner. After tuning is completed, turn the internal tuner ON. Otherwise, both tuners tune simultaneously and correct tuning may not be obtained.

See the instruction manual included with each antenna tuner for their respective operations.

### ◇ If the tuner cannot tune the antenna

Check the following and try again:

- the [ANT] connector selection.
- the antenna connection and feedline.
- the untuned antenna SWR. (Less than 3:1 for HF bands; Less than 2.5:1 for 50 MHz band)
- the transmit power. (8 W for HF bands; 15 W for 50 MHz band)
- the power source voltage/capacity.

If the tuner cannot reduce the SWR to less than 1.5:1 after checking the above, perform the following:

- repeat manual tuning several times.
- tune with a 50  $\Omega$  dummy load and re-tune the antenna.
- turn power OFF and ON.
- adjust the antenna feedline length.

(This is effective for higher frequencies in some cases.)

- Some antennas, especially for the low bands, have a narrow bandwidth. These antennas may not be tuned beyond the edge of their operating bandwidth, therefore, tune such an antenna as follows:

**[Example]:** Suppose you have an antenna which has an SWR of 1.5:1 at 3.55 MHz and an SWR of 3:1 at 3.8 MHz.

- ① Push [TUNER] to turn the antenna tuner ON.
- ② Select CW mode.
- ③ Turn OFF the break-in function. (p. 6-3)
- ④ Push [TRANSMIT] to set to the transmit condition.
- ⑤ Set 3.55 MHz and key down.
- ⑥ Set 3.80 MHz and key down.
- ⑦ Push [TRANSMIT] to return to the receive condition.



■ Time set mode .....	11-2
■ Daily timer setting .....	11-3
■ Setting sleep timer .....	11-4
■ Timer operation .....	11-4

## Time set mode

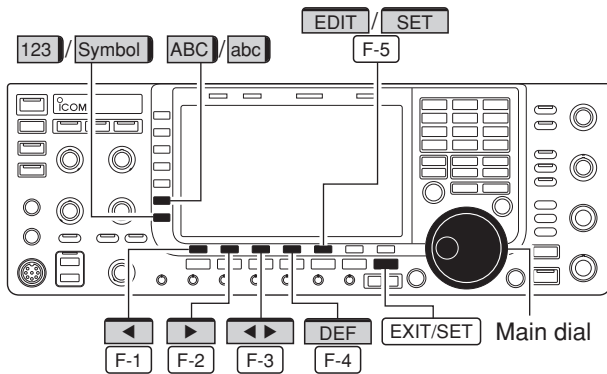

The IC-7700 has a built-in calendar and 24-hour clock (accuracy  $\pm 75$  seconds per month) with daily power ON/OFF timer functions. Before operating these timer functions, set the current date and time.

- ① Push [EXIT/SET] to close multi-function screen, if necessary.
- ② Push [SET] [F-7] to select set mode menu screen.
- ③ Push [TIME] [F-4] to select time set mode.
- ④ Push [▲] [F-1] or [▼] [F-2] to select the desired item.
- ⑤ Rotate the main dial to set or select the desired value or condition.
- ⑥ Push [EXIT/SET] to exit time set mode.

<b>Date</b>	<b>2000 - 1 - 1 ( Sat )</b>
Sets the date.	<ol style="list-style-type: none"> <li>① Push [◀ ▶] [F-3] to select between the year and the month/day, then rotate the main dial to select them. <ul style="list-style-type: none"> <li>• The date setting and “DATE-set Push [SET]” indicators blink.</li> </ul> </li> <li>② Push [SET] [F-5] to set the date.</li> </ol>
<b>Time (Now)</b>	<b>1:23</b>
Sets the local time.	<ol style="list-style-type: none"> <li>① Rotate the main dial to set the local time. <ul style="list-style-type: none"> <li>• The time setting and “TIME-set Push [SET]” indicators blink.</li> </ul> </li> <li>② Push [SET] [F-5] to set the time.</li> </ol>
<b>CLOCK2 Function</b>	<b>ON</b>
Turns the CLOCK2 indicator ON and OFF. CLOCK2 is convenient to display UTC or other country's local time, etc.	<ul style="list-style-type: none"> <li>• ON : The CLOCK2 indicator is displayed below the local time display.</li> <li>• OFF : The CLOCK2 indicator does not display.</li> </ul>
<b>CLOCK2 Offset</b>	<b>± 0:00</b>
Sets the desired off-set time period for CLOCK2 display within -24:00 to +24:00 in 5 minute steps.	<ul style="list-style-type: none"> <li>• Hold down [DEF] [F-4] for 1 second to select the default value.</li> </ul>
<b>CLOCK2 Name</b>	<b>UTC</b>
Sets the desired 3-character name for CLOCK2.  Capital letters, small letters, numerals, some symbols (! # \$ % & ¥ ? " ` ^ + - * / . , : ; = < > ( ) [ ] { }   _ ~ @) and spaces can be used.	<ol style="list-style-type: none"> <li>① Push [EDIT] [F-5] to select the name edit condition. <ul style="list-style-type: none"> <li>• The cursor under the 1st character blinks.</li> </ul> </li> <li>② Push [ABC], [abc], [123] or [Symbol] to select the character group, then rotate the main dial to select the character. <ul style="list-style-type: none"> <li>• Push [ABC] or [abc] to toggle capital and small letters.</li> <li>• Push [123] or [Symbol] to toggle numerals and symbols.</li> <li>• Push [◀] [F-1] or [▶] [F-2] for cursor movement.</li> <li>• Push [DEL] [F-3] to delete the selected character.</li> <li>• Push [SPACE] [F-4] to input a space.</li> <li>• Pushing the transceiver's keypad, [0]–[9], can also enter numerals.</li> </ul> </li> <li>③ Push [EXIT/SET] to set the name.</li> </ol>



## ■ Daily timer setting

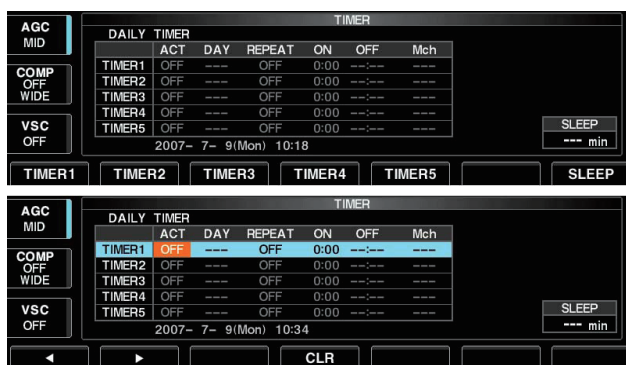
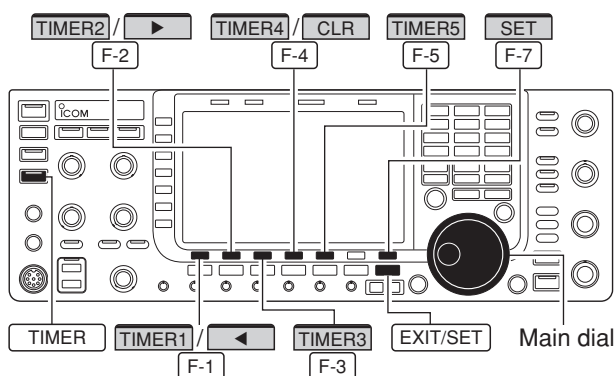

The transceiver turns power ON and/or OFF automatically on the specified day and time, with the specified frequency settings.

- ① Push [EXIT/SET] several times to close multi-function screen, if necessary.
- ② Hold down [TIMER] for 1 second to select timer set screen.
- ③ Push one of [TIMER1] [F-1] to [TIMER5] [F-5] to select the desired timer.
- ④ Rotate the main dial to select the timer action ON or OFF.
  - Select “- - -” not to specify the day of the week. The timer will function every day in this case.
  - Once a day of the week is selected, push [CLR] [F-4] to select “- - -”.
- ⑥ Push [▶] [F-2] to select the “REPEAT” cell, then rotate the main dial to select the repeat function ON or OFF.
  - ON : The timer functions every selected day of the week. (repeats)
  - OFF : The timer does not repeat.
- ⑦ Push [▶] [F-2] to select the “ON” cell, then rotate the main dial to set the desired transceiver power ON time.
  - When using power OFF timer only, push [CLR] [F-4] to select “- - -.” This setting cannot be set when the power OFF timer is set to “- - -.”
- ⑧ Push [▶] [F-2] to select the “OFF” cell, then rotate the main dial to set the desired transceiver power OFF time.
  - When using power ON timer only, push [CLR] [F-4] to select “- - -.” This setting cannot be set when the power ON timer is set to “- - -.”
- ⑨ Push [▶] [F-2] to select the “Mch” cell, then rotate the main dial to select the desired memory channel number.
  - If using the currently set VFO condition, push [CLR] [F-4] to select “- - -.”
- ⑩ Push [SET] [F-7] to set the timer.
  - The timer indicator above [TIMER] switch lights green.
- ⑪ Repeat steps ③ to ⑩ to set other timers, if desired.
- ⑫ Push [EXIT/SET] to exit timer set screen.

## Setting sleep timer

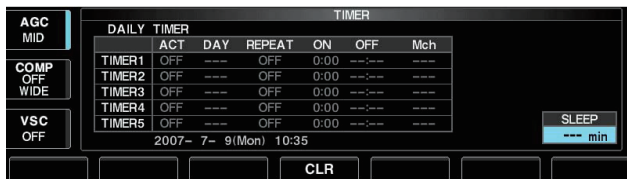
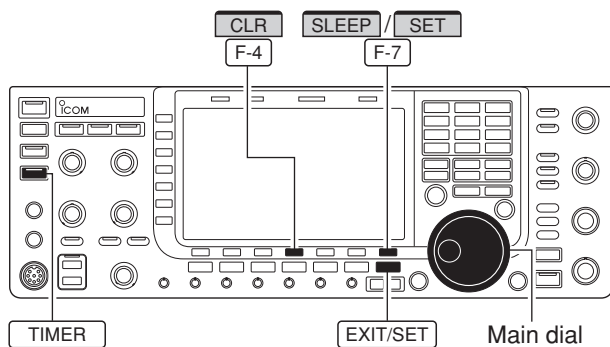

The sleep timer turns the transceiver power OFF automatically after passing the set period. The timer can be set to 5–120 minutes in 5 minute steps.

The sleep timer function counts the ‘minute’ units, and does not count the ‘second’ units. For example, when the sleep timer is started at 12:00 59, first one minute past for just 1 second. The maximum error is therefore 59 seconds. This is normal, not a malfunction.

- ① Push [EXIT/SET] several times to close a multi-function screen, if necessary.
- ② Hold down [TIMER] for 1 second to select timer set screen.
- ③ Push [SLEEP] [F-7] to select the sleep timer set condition.
  - “--” blinks.
- ④ Set the desired time period using the main dial.
  - “TIMER-set Push [SET]” blinks.
  - Push [CLR] [F-4] to select “--” to cancel the setting.
- ⑤ Push [SET] [F-7] to set the time.
  - Push [EXIT/SET] to cancel the setting.
  - The timer indicator above [TIMER] switch lights green.
- ⑥ Push [EXIT/SET] to exit timer set screen.
- ⑦ The transceiver emits 10 beeps and turns OFF after the sleep timer period elapses.
  - The timer indicator blinks while beeping.
  - Push [TIMER] momentarily to cancel the sleep timer, if desired.

## Timer operation

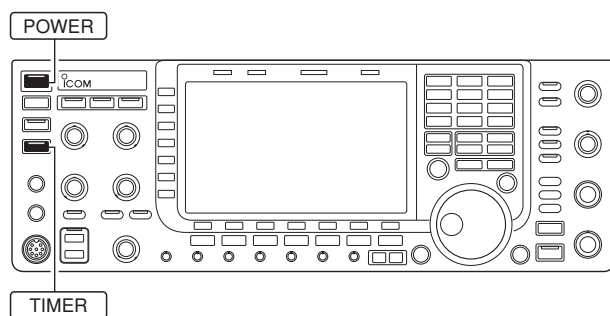

- ① Preset the daily timer as described previously.
- ② Push [TIMER] momentarily to turn the timer function ON.
  - The timer indicator above this switch lights green when the timer function is ON.
- ③ Hold down [POWER] for 1 second to turn the power OFF.
  - The timer indicator lights continuously.
- ④ When the set time arrives, the power is automatically turned ON.
- ⑤ The transceiver emits 10 beeps and turns OFF after the power-off period elapses.
  - The timer indicator blinks while beeping.
  - Push [TIMER] momentarily to cancel the sleep timer, if desired.

Timer action in the timer set screen must be selected ON to enable timer operation, described in page 11-3 steps ④.

■ Set mode description .....	12-2
◇ Set mode operation .....	12-2
◇ Screen arrangement .....	12-3
■ Level set mode .....	12-4
■ ACC set mode .....	12-7
■ Display set mode .....	12-10
■ Others set mode .....	12-12
■ USB-Memory set menu .....	12-23
◇ USB-Memory set screen arrangement .....	12-23
◇ Save option set mode .....	12-24
◇ Load option set mode .....	12-25
■ File saving .....	12-26
■ File loading .....	12-27
■ Changing a file name .....	12-28
■ Deleting a file .....	12-29
■ Unmounting USB flash drive .....	12-29
■ Formatting USB flash drive .....	12-30

## ■ Set mode description

### ◇ Set mode operation

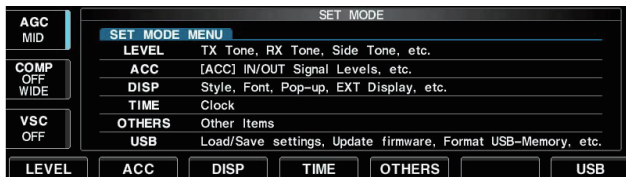
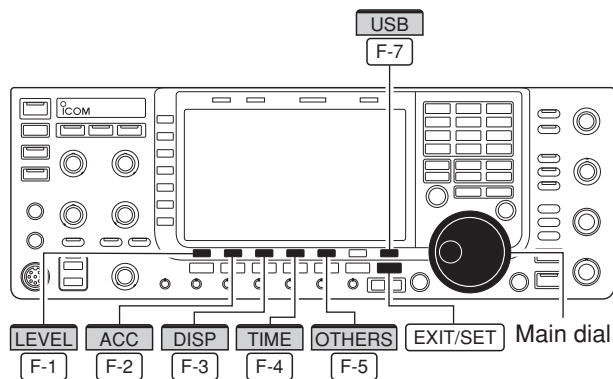

Set mode is used for programming infrequently changed values or conditions of functions. The IC-7700 has a level set mode, display set mode, time set mode, accessory set mode, others set mode and USB-Memory set menu.

- ① Push **[EXIT/SET]** several times to close a multi-function screen, if necessary.
- ② Push **[SET]** **[F-7]** to select set mode menu screen.
  - Holding down **[EXIT/SET]** for 1 second also selects set mode menu screen.
- ③ Push **[LEVEL]** **[F-1]**, **[ACC]** **[F-2]**, **[DISP]** **[F-3]**, **[TIME]** **[F-4]**, **[OTHERS]** **[F-5]** or **[USB]** **[F-7]** to enter the desired set mode.
- ④ For level, accessory, display and Others set mode, push **[WIDE]** **[F-7]** to toggle wide and normal screen.
- ⑤ Push **[▲]** **[F-1]** or **[▼]** **[F-2]** to select the desired item, then rotate the main dial to adjust/select the desired value or condition.
  - Pushing **[◀ ▶]** **[F-3]** operation may be necessary for some items.
- ⑥ Push **[EXIT/SET]** twice to exit set mode.

◇ Screen arrangement



• Display set mode (p. 12-10)



• Set mode menu screen (p. 12-2)

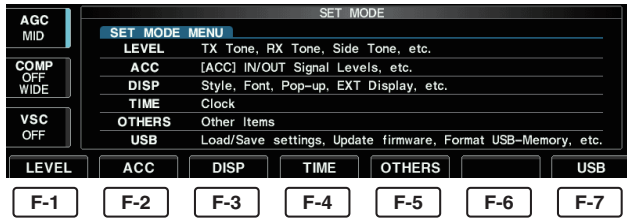

• Time set mode (p. 11-2)

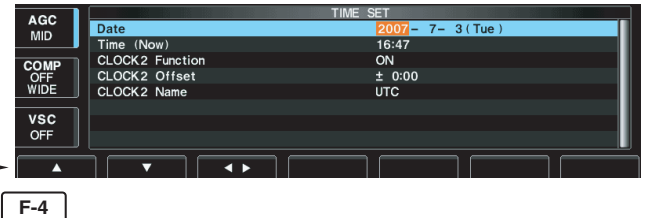

• Level set mode (p. 12-4)



• Others set mode (p. 12-12)

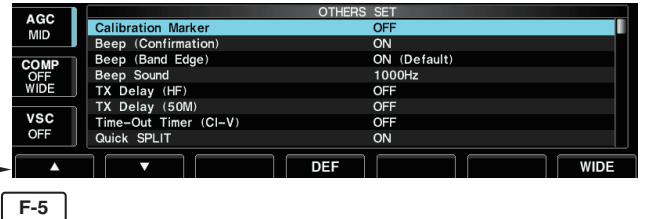

• ACC set mode (p. 12-7)





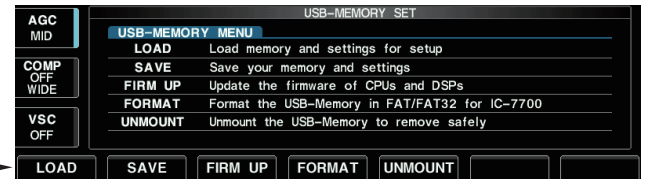





• USB-Memory set menu (p. 12-23)







## ■ Level set mode

<b>SSB RX HPF/LPF</b> 	
<p>Sets the high-pass filter (100 Hz to 2000 Hz) and low-pass filter (500 Hz to 2400) of the receive audio in 100 Hz steps in SSB mode. (default: OFF)</p>	<p><b>NOTE:</b> When this setting is active, below 2 items will be reset to default value, '0.'</p>
<b>Tone (Bass)</b> 	<b>0</b>
<p>Sets the bass level of the receive audio tone in SSB mode from -5 to +5. (default: 0)</p>	
<b>Tone (Treble)</b> 	<b>0</b>
<p>Sets the treble level of the receive audio tone in SSB mode from -5 to +5. (default: 0)</p>	
<b>AM RX HPF/LPF</b> 	
<p>Sets the high-pass filter (100 Hz to 2000 Hz) and low-pass filter (500 Hz to 2400) of the receive audio in 100 Hz steps in AM mode. (default: OFF)</p>	<p><b>NOTE:</b> When this setting is active, below 2 items will be reset to default value, '0.'</p>
<b>Tone (Bass)</b> 	<b>0</b>
<p>Sets the bass level of the receive audio tone in AM mode from -5 to +5. (default: 0)</p>	
<b>Tone (Treble)</b> 	<b>0</b>
<p>Sets the treble level of the receive audio tone in AM mode from -5 to +5. (default: 0)</p>	
<b>FM RX HPF/LPF</b> 	
<p>Sets the high-pass filter (100 Hz to 2000 Hz) and low-pass filter (500 Hz to 2400) of the receive audio in 100 Hz steps in FM mode. (default: OFF)</p>	<p><b>NOTE:</b> When this setting is active, below 2 items will be reset to default value, '0.'</p>
<b>Tone (Bass)</b> 	<b>0</b>
<p>Sets the bass level of the receive audio tone in FM mode from -5 to +5. (default: 0)</p>	
<b>Tone (Treble)</b> 	<b>0</b>
<p>Sets the treble level of the receive audio tone in FM mode from -5 to +5. (default: 0)</p>	

## ■ Level set mode (continued)

<b>CW RX HPF/LPF</b>	
Sets the high-pass filter (100 Hz to 2000 Hz) and low-pass filter (500 Hz to 2400) of the receive audio in 100 Hz steps in CW mode. (default: OFF)	
<b>RTTY RX HPF/LPF</b>	
Sets the high-pass filter (100 Hz to 2000 Hz) and low-pass filter (500 Hz to 2400) of the receive audio in 100 Hz steps in RTTY mode. (default: OFF)	
<b>PSK RX HPF/LPF</b>	
Sets the high-pass filter (100 Hz to 2000 Hz) and low-pass filter (500 Hz to 2400) of the receive audio in 100 Hz steps in PSK mode. (default: OFF)	
<b>SSB TX Tone (Bass)</b>	 0
Sets the bass level of the transmit audio tone in SSB mode from -5 to +5. (default: 0)	
<b>Tone (Treble)</b>	 0
Sets the treble level of the transmit audio tone in SSB mode from -5 to +5. (default: 0)	
<b>AM TX Tone (Bass)</b>	 0
Sets the bass level of the transmit audio tone in AM mode from -5 to +5. (default: 0)	
<b>Tone (Treble)</b>	 0
Sets the treble level of the transmit audio tone in AM mode from -5 to +5. (default: 0)	
<b>FM TX Tone (Bass)</b>	 0
Sets the bass level of the transmit audio tone in FM mode from -5 to +5. (default: 0)	
<b>Tone (Treble)</b>	 0
Sets the treble level of the transmit audio tone in FM mode from -5 to +5. (default: 0)	

■ Level set mode (continued)

<b>SSB TBW (WIDE)</b>	<b>100 – 2900</b>
Sets the transmission passband width to a wide setting by changing the lower and higher cut-off frequencies.	Lower freq. : 100 (default), 200, 300 and 500 Hz Higher freq.: 2500, 2700, 2800 and 2900 Hz (default)
<b>SSB TBW (MID)</b>	<b>300 – 2700</b>
Sets the transmission passband width to a middle setting by changing the lower and higher cut-off frequencies.	Lower freq. : 100, 200, 300 (default) and 500 Hz Higher freq.: 2500, 2700 (default), 2800 and 2900 Hz
<b>SSB TBW (NAR)</b>	<b>500 – 2500</b>
Sets the transmission passband width to a narrow setting by changing the lower and higher cut-off frequencies.	Lower freq. : 100, 200, 300 and 500 Hz (default) Higher freq.: 2500 (default), 2700, 2800 and 2900 Hz
<b>Speech Level</b>	 <b>50%</b>
Sets the side tone output level from 0 to 100% in 1% steps. (default: 50%)	
<b>Side Tone Level</b>	 <b>50%</b>
Sets the side tone output level from 0 to 100% in 1% steps. (default: 50%)	
<b>Side Tone Level Limit</b>	<b>ON</b>
Turns the side tone output level limiting capability ON or OFF. (default: ON)	
<b>APF AF Level</b>	 <b>0dB</b>
Sets the audio level that the audio peak filter is ON in the CW mode, from 0 to +6 dB in 1dB step. (default: 0dB)	
<b>Beep Level</b>	 <b>50%</b>
Sets the key-touch beep output level from 0 to 100% in 1% steps. (default: 50%)	
<b>Beep Level Limit</b>	<b>ON</b>
Turns the key-touch beep output level limiting capability ON or OFF. (default: ON)	
<b>Phones Level Ratio</b>	 <b>1.00</b>
Sets the ratio for audio output level from the headphone toward to the internal speaker within a range of 0.60 to 1.40 in 0.01 steps. (default: 1.00)	



## ■ ACC set mode

<b>ACC AF Output Level</b> <b>50%</b>	
Sets the desired audio output level, output from [ACC1], within 0 to 100% in 1% steps.	<ul style="list-style-type: none"> <li>• Outputs approximately 200 mV at 50% (default) setting.</li> </ul>
<b>S/PDIF Output Level</b> <b>100%</b>	
Sets the desired output level of [S/P DIF], within 0 to 100% in 1% steps. (default: 100%)	
<b>ACC MOD Level</b> <b>50%</b>	
Sets the desired audio input level for modulation from [ACC1].	<ul style="list-style-type: none"> <li>• Approximately 100 mV at 50% (default) setting.</li> </ul>
<b>S/PDIF MOD Level</b> <b>50%</b>	
Sets the desired input level for modulation from [S/P DIF], within 0 to 100% in 1% steps. (default: 50%)	
<b>LAN MOD Level</b> <b>50%</b>	
Sets the desired input level for modulation from [LAN], within 0 to 100% in 1% steps. (default: 50%)	
<b>DATA OFF MOD</b>	<b>MIC,ACC</b>
Selects the desired connector(s) for modulation input when data mode is not in use.	<ul style="list-style-type: none"> <li>• MIC : Use the signals from [MIC].</li> <li>• ACC : Use the signals from [ACC1] (pin 4).</li> <li>• MIC,ACC : Use the signals from [MIC] and [ACC1] (pin 4). (default)</li> <li>• S/P DIF : Use the signals from [S/P DIF].</li> <li>• LAN : Use the signals from [LAN].</li> </ul>
<b>DATA1 MOD</b>	<b>ACC</b>
Selects the desired connector(s) for modulation input when data 1 mode (D1) is in use.	<ul style="list-style-type: none"> <li>• MIC : Use the signals from [MIC].</li> <li>• ACC : Use the signals from [ACC1] (pin 4). (default)</li> <li>• MIC,ACC : Use the signals from [MIC] and [ACC1] (pin 4).</li> <li>• S/P DIF : Use the signals from [S/P DIF].</li> <li>• LAN : Use the signals from [LAN].</li> </ul>

## ■ ACC set mode (continued)

<b>DATA2 MOD</b>	<b>MIC,ACC</b>
Selects the desired connector(s) for modulation input when data 2 mode (D2) is in use.	<ul style="list-style-type: none"> <li>• MIC : Use the signals from [MIC].</li> <li>• ACC : Use the signals from [ACC1] (pin 4).</li> <li>• MIC,ACC : Use the signals from [MIC] and [ACC1] (pin 4). (default)</li> <li>• S/P DIF : Use the signals from [S/P DIF].</li> <li>• LAN : Use the signals from [LAN].</li> </ul>
<b>DATA3 MOD</b>	<b>MIC</b>
Selects the desired connector(s) for modulation input when data 3 mode (D3) is in use.	<ul style="list-style-type: none"> <li>• MIC : Use the signals from [MIC]. (default)</li> <li>• ACC : Use the signals from [ACC1] (pin 4).</li> <li>• MIC,ACC : Use the signals from [MIC] and [ACC1] (pin 4).</li> <li>• S/P DIF : Use the signals from [S/P DIF].</li> <li>• LAN : Use the signals from [LAN].</li> </ul>
<b>SEND Relay Type</b>	<b>MOS-FET</b>
Selects the switching relay type for [RELAY] from Reed and MOSFET. Select the suitable relay type when connecting a non-Icom linear amplifier.	<ul style="list-style-type: none"> <li>• Reed : Use mechanical relay. (16 V DC/0.5 A maximum)</li> <li>• MOS-FET: Use semiconductor type relay. (250 V/200 mA maximum: default)</li> </ul>
<b>External Meter Output</b>	<b>Auto</b>
Selects the desired item for an external meter indication.	<ul style="list-style-type: none"> <li>• Auto : Outputs the receiving signal strength level during receive, and outputs the selected level (selected with [METER]), during transmit. (default)</li> <li>• S : Outputs the receiving signal strength level during receive.</li> <li>• Po : Outputs the transmitting power level during transmit.</li> <li>• SWR : Outputs the VSWR level during transmit.</li> <li>• ALC : Outputs the ALC level during transmit.</li> <li>• COMP : Outputs the compression level during transmit.</li> <li>• V<sub>D</sub> : Outputs the drain terminal voltage of the final amplifier MOSFETs.</li> <li>• I<sub>D</sub> : Outputs the drain current of the final amplifier MOSFETs.</li> </ul>
<b>External Meter Level</b>	 <b>50%</b>
Sets the output level for an external meter indication within 0 to 100% range in 1% steps.	<ul style="list-style-type: none"> <li>• Approximately 2.5 V at 50% (default) setting for full-scale indication. (4.7 kΩ impedance)</li> </ul>

## ■ ACC set mode (continued)

REF IN/OUT	OFF
<p>Selects the transceiver's reference signal condition from IN, OFF and OUT.</p>	<ul style="list-style-type: none"> <li>• IN : Use an external reference signal for the IC-7700. Turn the transceiver power OFF then ON to make the setting effective.</li> <li>• OFF : Not input/output the reference signal. (default)</li> <li>• OUT : Outputs the IC-7700 reference signal to externally connected equipment(s) for their reference.</li> </ul> <p><b>NOTE:</b> If the applied reference signal is off-frequency, or no signal is applied with "IN" selection, the IC-7700 will not work properly. Select "OFF" or "OUT" then reboot the IC-7700 in such case.</p>
REF Adjust	 50%
<p>Adjusts the internal reference signal frequency within 0 to 100% range in 1% steps during frequency calibration.</p>	<p><b>NOTE:</b> Default setting is different for each transceiver.</p>

## ■ Display set mode

<b>LCD Unit Bright</b>			<b>50%</b>
Adjusts the LCD unit brightness from 0 (dark) to 100% (bright) range in 1% steps. (default: 50%)			
<b>Backlight (Switches)</b>			<b>80</b>
Adjusts the switch indicators brightness from 1 (dark) to 100 (bright) range in 1 steps. (default: 80)			
<b>Display Type</b>		<b>A</b>	
Selects the desired display type from A (Black back) and B (Blue back). (default: A)		See page13-4 for details.	
<b>Display Font</b>		<b>Basic (1)</b>	
Selects the desired font for frequency readout from Basic (1), Basic (2), Italic, Round and Slim. (default: Basic (1))		See page13-4 for details.	
<b>Meter Response</b>		<b>MID</b>	
Set meter needle response between SLOW, MID and FAST. (default: MID)		This setting is effective for the standard and edge-wise meter type selections only.	
<b>Meter Type (Normal Screen)</b>		<b>Standard</b>	
Selects the desired S/RF meter type during wide screen or mini scope display from Edgewise and Bar. (default: Bar)			
<b>Meter Type (Wide Screen)</b>		<b>Bar</b>	
Selects the desired S/RF meter type during wide screen or mini scope display from Edgewise and Bar. (default: Bar)			
<b>Meter Peak Hold (Bar)</b>		<b>ON</b>	
Turns the meter peak hold function ON or OFF. (default: ON) This function is used for the bar meter only.			
<b>Memory Name</b>		<b>ON</b>	
Sets the memory name display, during memory mode operation, ON or OFF. (default: ON)		<ul style="list-style-type: none"> <li>• ON : The programmed memory name is displayed above the frequency display.</li> <li>• OFF : No memory name is displayed even a memory name is programmed.</li> </ul>	
<b>APF-Width Popup (APF OFF→ON)</b>		<b>ON</b>	
Enables the pop-up display capability for the APF filter width when the APF filter is turned ON. (default: ON)			

## ■ Display set mode (continued)

<b>MN-Q Popup (MN OFF→ON)</b>		<b>ON</b>
Enables the pop-up display capability for the notch filter width when the manual notch filter is turned ON. (default: ON)		
<b>Screen Saver Function</b>		<b>60min</b>
Turns the screen saver function ON (15, 30 or 60 minutes) and OFF. (default: 60 minutes)		
The screen saver will activate when no operation is performed for the selected time period to protect the LCD from the “burn-in” effect.		
<b>Screen Saver Type</b>		<b>Bound</b>
Selects the screen saver type from “Bound,” “Rotation” and “Twist.” (default: Bound)		
The screen saver pattern can be displayed for your reference while holding down [PREVIEW] <b>[F-5]</b> .		
<b>External Display</b>		<b>OFF</b>
Select “ON” when the external display is connected. (default: OFF)		
• At least 800×600 pixel resolution is required for the display.		
<b>External Display Sync Pulse</b>		<b>H</b>
Selects the suitable pulse level for the connected external display from H and L. (default: H)		
<b>Opening Message</b>		<b>ON</b>
Turns the opening message screen display capability ON or OFF. (default: ON)		
<b>My Call</b>		
Sets the introductory text, up to 10-character long, displayed in the opening screen. Usually, you set your call sign for the opening screen.		
Capital letters, small letters, numerals, some symbols (– / . @) and spaces can be used.		
<ol style="list-style-type: none"> <li>1 Push [EDIT] <b>[F-5]</b> to select the name edit condition. <ul style="list-style-type: none"> <li>• The cursor under the 1st character blinks.</li> </ul> </li> <li>2 Push [ABC] (MF6), [abc] (MF6), [123] (MF7) or [Symbol] (MF7) to select the character group, then rotate the main dial to select the character. <ul style="list-style-type: none"> <li>• Push [ABC] (MF6) or [abc] (MF6) to toggle capital and small letters.</li> <li>• Push [123] (MF7) or [Symbol] (MF7) to toggle numerals and symbols.</li> <li>• Push [◀] <b>[F-1]</b> or [▶] <b>[F-2]</b> for cursor movement.</li> <li>• Push [DEL] <b>[F-3]</b> to delete the selected character.</li> <li>• Push [SPACE] <b>[F-4]</b> to input a space.</li> <li>• Pushing the transceiver’s keypad, [0]–[9], can also enter numerals.</li> </ul> </li> <li>3 Push [EXIT/SET] to set the name.</li> </ol>		

## Other set mode

<b>Calibration Marker</b>	<b>OFF</b>
<p>This item is used for a simple frequency check of the transceiver. (default: OFF) See page 13-5 for calibration procedure.</p> <p><b>NOTE:</b> Turn the calibration marker OFF after checking the frequency of the transceiver.</p>	
<b>Beep (Confirmation)</b>	<b>ON</b>
<p>A beep sounds each time a switch is pushed to confirm it. This function can be turned OFF for silent operation. (default: ON)</p> <p>The beep output level can be set in level set mode. (p. 12-6)</p>	
<b>Beep (Band Edge)</b>	<b>ON (Default)</b>
<p>When you tune into or out of an amateur band's frequency range, a beep sounds. This functions independently of the confirmation beep setting (above).</p> <p> A different beep tone sounds when you tune in or out of an amateur band's frequency range. A regular beep sounds when you tune into a band, and an lower tone error beep will sound when you tune out of a band.</p> <p>The beep output level can be set in the level set mode. (p. 12-6)</p> <p>When "ON (User)" or "ON (User) &amp; TX Limit" is selected, [BAND] appears in the display above the function switch [F-5]. Up to 30 band edge frequencies can be programmed in the band edge screen.</p> <p>See page 3-14 for programming details.</p>	
<b>Beep Sound</b>	<b>1000Hz</b>
<p>Sets the desired key-touch beep frequency within 500 to 2000 Hz in 10 Hz steps. (default: 1000 Hz)</p>	
<b>TX Delay (HF)</b>	<b>OFF</b>
<p>Sets the transmission's timing for the HF bands. When an external device, such as a vacuum tube linear amplifier or a receiver preamplifier, is connected to the transceiver and you use the SEND line, a problem could possibly occur. If the device's transmit/receive switching time is slower than the time for the Icom transceiver, the device may not yet ready for a transmitted signal, and could be damaged by the transceivers RF power. If necessary to prevent damage to the external device, set an appropriate TX delay.</p>	
<ul style="list-style-type: none"> <li>• OFF : The transmission delay is disabled. (default)</li> <li>• 10 to 30ms: After transmit operation, the TX output is delayed for the set period of time (10, 15, 20, 25 or 30 milliseconds).</li> </ul>	

## ■ Other set mode (continued)

<b>TX Delay (50M)</b>	<b>OFF</b>
<p>Sets the transmission's timing for the 50 MHz band.</p> <p>See the previous item "TX Delay (HF)" for more details.</p>	
<b>Time-Out Timer (CI-V)</b>	<b>OFF</b>
<p>Turns the Time-Out Timer function ON (3, 5, 10, 20 or 30 minutes) or OFF. If a continuous transmission exceeds the selected time period, the transmission will be cut off, to prevent a prolonged transmission. (default: OFF)</p> <p><b>NOTE:</b> This function will be activated only when you transmit using CI-V commands, or pushing <b>TRANSMIT</b>.</p>	
<b>Quick SPLIT</b>	<b>ON</b>
<p>When this item is set to ON, holding down <b>SPLIT</b> for 1 second sets the unselected VFO's readout frequency to the selected VFO's readout frequency and activates split operation. (default: ON)</p> <p>See page 6-7 for details.</p>	
<b>FM SPLIT Offset(HF)</b>	<b>-0.100MHz</b>
<p>Sets the offset (difference between transmit and receive frequencies) for the quick split function. This setting is used for HF bands in FM mode only and is used to input the repeater offset for an HF band.</p> <p>The offset frequency can be set from -9.999 MHz to +9.999 MHz in 1 kHz steps. (default: -0.100 MHz)</p>	
<b>FM SPLIT Offset(50M)</b>	<b>-0.500MHz</b>
<p>Sets the offset (difference between transmit and receive frequencies) for the quick split function. This setting is used for 50 MHz band FM mode only, and is used to input the repeater offset for the 50 MHz band.</p> <p>The offset frequency can be set from -9.999 MHz to +9.999 MHz in 1 kHz steps. (default: -0.500 MHz)</p>	
<b>SPLIT LOCK</b>	<b>OFF</b>
<p>When this item is ON, the main dial can be used to adjust the transmit frequency while pushing [XFC] even while the lock function is activated. (default: OFF)</p> <p>See pages 6-6 and 6-7 for split frequency operation details.</p>	

■ Other set mode (continued)

<b>Tuner (Auto Start)</b>	<b>OFF</b>
The internal antenna tuner has an automatic start capability which starts tuning if the SWR is higher than 1.5–3:1.	<ul style="list-style-type: none"> <li>• OFF : The tuner remains OFF even when the SWR is poor (1.5–3:1). (default)</li> <li>• ON : Automatic tune starts even when the tuner is turned OFF during HF bands operation.</li> </ul>
<b>Tuner (PTT Start)</b>	<b>OFF</b>
Tuning of the internal antenna tuner can be started automatically at the moment the PTT is pushed after the operating frequency is changed (more than 1% from last-tuned frequency). (default: OFF)	
<b>Transverter Function</b>	<b>Auto</b>
Selects the transverter operation condition from Auto and ON. (default: Auto)	<ul style="list-style-type: none"> <li>• ON : Turn the transverter operation ON.</li> <li>• Auto: The transceiver turns into transverter operation condition when 2 to 13.8 V DC is applied to [ACC2] pin 6.</li> </ul>
<b>Transverter Offset</b>	<b>16.000MHz (14.000.00→30.000.00)</b>
Sets the desired offset frequency for the transverter operation within 0.000 to 99.999 MHz in 1 kHz steps. (default: 16.000 MHz)	
<b>RTTY Mark Frequency</b>	<b>2125</b>
Selects the RTTY mark frequency. RTTY mark frequency is switched between 1275, 1615 and 2125 Hz. (default: 2125 Hz)	2125 Hz is automatically selected when the internal RTTY decoder is used.
<b>RTTY Shift Width</b>	<b>170</b>
Selects the RTTY shift width. There are 3 selectable values: 170, 200 and 425 Hz. (default: 170 Hz)	170 Hz is automatically selected when the internal RTTY decoder is used.
<b>RTTY Keying Polarity</b>	<b>Normal</b>
Selects the RTTY keying polarity. Normal or reverse keying polarity can be selected. (default: Normal)	<p>When reverse polarity is selected, Mark and Space are reversed.</p> <ul style="list-style-type: none"> <li>• Normal : Key open/close = Mark/Space</li> <li>• Reverse : Key open/close = Space/Mark</li> </ul>
<b>PSK Tone Frequency</b>	<b>1500</b>
Selects the desired PSK tone frequency for the PSK reception from 1000, 1500 and 2000 Hz. (default: 1500 Hz)	
<b>SPEECH Language</b>	<b>English</b>
Selects the speech language from English and Japanese. (default: English)	
<b>SPEECH Speed</b>	<b>HIGH</b>
Selects the speech speed from HIGH (faster) and LOW (slower). (default: HIGH)	



## ■ Other set mode (continued)

<b>SPEECH S-Level</b>	<b>ON</b>
The IC-7700 speech processor can announce frequency, mode and signal level. Signal level announcement can be deactivated if desired. (default: ON)	When "OFF" is selected, the signal level is not announced.
<b>SPEECH [MODE] Switch</b>	<b>OFF</b>
Selects the operating mode speech capability when a mode switch is pushed; ON or OFF. (default: OFF)	When "ON" is selected, the selected operating mode is announced when a mode switch is pushed.
<b>Memopad Numbers</b>	<b>5</b>
Sets the number of memo pad channels available. 5 or 10 memo pads can be selected. (default: 5)	
<b>MAIN DIAL Auto TS</b>	<b>HIGH</b>
Sets the auto tuning step function for the main dial. When rotating the main dial rapidly, the tuning step automatically changes several times as selected.  There are 2 type of auto tuning steps: HIGH (Fastest) and LOW (Faster). (default: HIGH)	<ul style="list-style-type: none"> <li>• HIGH : Auto tuning step is turned ON. Fastest tuning step during rapid rotation. (default)</li> <li>• LOW : Auto tuning step is turned ON. Faster tuning step during rapid rotation.</li> <li>• OFF : Auto tuning step is turned OFF.</li> </ul>
<b>MIC Up/Down Speed</b>	<b>HIGH</b>
Sets the rate at which frequencies are scanned when the microphone [UP]/[DN] switches are held down. HIGH or LOW can be selected.	<ul style="list-style-type: none"> <li>• HIGH : High speed (default: 50 tuning steps/second)</li> <li>• LOW : Low speed (25 tuning steps/second)</li> </ul>
<b>Quick RIT/<math>\Delta</math>TX Clear</b>	<b>OFF</b>
Selects the RIT/ $\Delta$ TX frequency clearing instruction with the <input type="button" value="CLEAR"/> switch.	<ul style="list-style-type: none"> <li>• ON : Clears the RIT/<math>\Delta</math>TX frequency when <input type="button" value="CLEAR"/> is pushed momentarily.</li> <li>• OFF : Clears the RIT/<math>\Delta</math>TX frequency when <input type="button" value="CLEAR"/> is held down for 1 second. (default)</li> </ul>
<b>[NOTCH] Switch (SSB)</b>	<b>Auto/Manual</b>
Selects notch functions for SSB mode operation from Auto, Manual and Auto/Manual.	<ul style="list-style-type: none"> <li>• Auto : Only the auto notch can be used.</li> <li>• Manual : Only the manual notch can be used.</li> <li>• Auto/Manual : Both the auto and manual notch can be used. (default)</li> </ul>
<b>[NOTCH] Switch (AM)</b>	<b>Auto/Manual</b>
Selects notch functions for AM mode operation from Auto, Manual and Auto/Manual.	<ul style="list-style-type: none"> <li>• Auto : Only the auto notch can be used.</li> <li>• Manual : Only the manual notch can be used.</li> <li>• Auto/Manual : Both the auto and manual notch can be used. (default)</li> </ul>
<b>DIGI-SEL VR Operation</b>	<b>DIGI-SEL</b>
Selects [DIGI-SEL] control function from DIGI-SEL and APF.	<ul style="list-style-type: none"> <li>• DIGI-SEL : [DIGI-SEL] control functions as the digital selector operation. (default)</li> <li>• APF : [DIGI-SEL] control functions as the audio peak filter adjustment.</li> </ul>

## Other set mode (continued)

<b>SSB/CW Synchronous Tuning</b>	<b>OFF</b>
<p>Selects the displayed frequency shift function from ON and OFF. (default: OFF)</p> <p>When this function is activated, the audio pitch or tones of the received signal will remain the same even when the operating mode is changed between SSB and CW.</p> <p>/// The amount of frequency shift may differ according to the CW pitch setting.</p>	<ul style="list-style-type: none"> <li>• ON : The displayed frequency shifts when the operating mode is changed between SSB and CW.</li> <li>• OFF : The displayed frequency does not shift.</li> </ul>
<b>CW Normal Side</b>	<b>LSB</b>
<p>Selects the side band used to receive CW in CW normal mode. (default: LSB)</p>	
<b>APF Type</b>	<b>SOFT</b>
<p>Select audio filter shape for APF from SOFT and SHARP. (default: SOFT)</p>	<ul style="list-style-type: none"> <li>• SOFT : Soft filter shape makes distinguishing noise and signals easier. The audio filter width is related to the CW pitch setting.</li> <li>• SHARP : Sharp filter shape rejects interfering signals more aggressively.</li> </ul>
<b>External Keypad (VOICE)</b>	<b>OFF</b>
<p>Sets the external keypad for voice message transmission capability ON or OFF.</p> <p>See page 2-7 for the equivalent circuit of an external keypad and connection.</p>	<ul style="list-style-type: none"> <li>• ON : Pushing one of external keypad switches, transmits the desired voice message contents during a phone mode operation. Holding down a switch to repeatedly transmit the desired memory contents.</li> <li>• OFF : External keypad does not function. (default)</li> </ul>
<b>External Keypad (KEYER)</b>	<b>OFF</b>
<p>Sets the external keypad for keyer memory transmission capability ON or OFF.</p> <p>See page 2-7 for the equivalent circuit of an external keypad and connection.</p>	<ul style="list-style-type: none"> <li>• ON : Pushing one of external keypad switches, transmits the desired keyer memory contents during CW mode operation. Holding down a switch to repeatedly transmit the desired memory contents.</li> <li>• OFF : External keypad does not function. (default)</li> </ul>
<b>External Keypad (RTTY)</b>	<b>OFF</b>
<p>Sets the external keypad for RTTY memory transmission capability ON or OFF.</p> <p>/// Only RTTY memory channels RT1, RT2, RT3 and RT4 can be transmitted using the external keypad.</p> <p>See page 2-7 for the equivalent circuit of an external keypad and connection.</p>	<ul style="list-style-type: none"> <li>• ON : In the RTTY mode, and while the RTTY decode screen is active, pushing one of the external keypad switches transmits the desired RTTY memory contents.</li> <li>• OFF : The external keypad does not function. (default)</li> </ul>

## ■ Other set mode (continued)

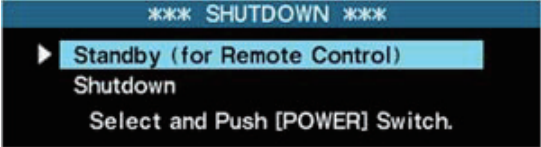
<p><b>External Keypad (PSK)</b></p> <p>Sets the external keypad for PSK memory transmission capability ON or OFF.</p> <p>/// Only PSK memory channels PT1, PT2, PT3 and PT4 can be transmitted using the external keypad.</p> <p>See page 2-7 for the equivalent circuit of an external keypad and connection.</p>	<p><b>OFF</b></p> <ul style="list-style-type: none"> <li>• ON : In the PSK mode, and while the PSK decode screen is active, pushing one of the external keypad switches transmits the desired PSK memory contents.</li> <li>• OFF : The external keypad does not function. (default)</li> </ul>
<p><b>Keyboard [F1]–[F4] (VOICE)</b></p> <p>Sets the voice message transmission capability when one of the [F1] to [F4] keys of the connected keyboard is pushed, to ON or OFF.</p>	<p><b>OFF</b></p> <ul style="list-style-type: none"> <li>• ON : Pushing one of the [F1] to [F4] keys transmits the desired voice message contents during phone mode operation. And while holding down the [SHIFT] key, push the [F1] to [F4] keys to transmit the desired keyer memory contents repeatedly.</li> <li>• OFF : The [F1] to [F4] keys do not function. (default)</li> </ul>
<p><b>Keyboard [F1]–[F4] (KEYER)</b></p> <p>Sets the keyer memory transmission capability when one of the [F1] to [F4] keys is pushed, to ON or OFF.</p>	<p><b>OFF</b></p> <ul style="list-style-type: none"> <li>• ON : Pushing one of the [F1] to [F4] keys transmits the desired keyer memory contents during CW mode operation. And while holding down the [SHIFT] key, push the [F1] to [F4] keys to transmit the desired keyer memory contents repeatedly.</li> <li>• OFF : The [F1] to [F4] keys do not function. (default)</li> </ul>
<p><b>Shutdown Function</b></p> <p>Selects the shutdown option between Standby/Shutdown and Shutdown, for turning ON the transceiver by Remote stations. (default: Shutdown)</p> <p><b>When this item is set to “Standby/Shutdown:</b></p> <p>① Holding down [POWER] for 1 second displays the dialog box below.</p>  <p>② Push [POWER] to turn OFF the power with the Standby mode.</p> <ul style="list-style-type: none"> <li>• If you want to select “Shutdown,” rotate the main dial or push [▼] [F-2], then push [POWER].</li> </ul>	<p><b>Shutdown</b></p> <p>Standby/Shutdown : You can turn ON the transceiver’s power using external equipment such as a PC with RS-BA1.</p> <p>Shutdown: Only the [POWER] switch turns ON the transceiver.</p> <div style="background-color: #f0f0f0; padding: 5px; margin-top: 10px;"> <p><b>NOTE while in the standby mode:</b></p> <ul style="list-style-type: none"> <li>• The internal cooling fan is active, this is normal; not malfunction.</li> </ul> </div>
<p><b>CI-V Baud Rate</b></p> <p>Sets the CI-V data transfer rate. 300, 1200, 4800, 9600, 19200 bps and “Auto” are available. (default: Auto)</p>	<p><b>Auto</b></p> <p>When “Auto” is selected, the baud rate is automatically set according to the data rate of connected controller.</p>

## Other set mode (continued)

<b>CI-V Address</b>	<b>74h</b>
To distinguish equipment, each CI-V transceiver has its own Icom standard address in hexadecimal code. The IC-7700's address is 74h.	When 2 or more IC-7700's are connected to an optional CT-17 CI-V LEVEL CONVERTER, rotate the main dial to select a different address for each IC-7700; the range is 01h to DFh.
<b>CI-V Transceive</b>	<b>ON</b>
Transceive operation is possible with the IC-7700 connected to other Icom HF transceivers or receivers.	When "ON" is selected, changing the frequency, operating mode, etc. on the IC-7700 automatically changes those of connected transceivers (or receivers) and vice versa.
<b>CI-V LAN→REMOTE Transceive Address</b>	<b>00h</b>
Sets the CI-V address for sending the transceive data from [LAN] to [REMOTE] or [RS-232C]. The [REMOTE] or [RS-232C] connectors output the transceive data with this setting Address.  When your system are configured with any other transceivers or receivers, and you do not want to change their frequency or operating mode by operating the RS-BA1, sets this address different with 00h.	<p>/// Only when you configure the remote control system using an optional RS-BA1, you need this setting.</p> <p>The IC-PW1 can receive the transceive data from other than 00h, so you can still operate the IC-PW1 by operating RS-BA1. In that case you must reset the IC-PW1 and set the CI-V settings again. See the IC-PW1's instruction manual for details.</p>
<b>CI-V Output (for ANT)</b>	<b>OFF</b>
Enables to output the antenna controller status (frequency and so on) from [REMOTE].	<ul style="list-style-type: none"> <li>• OFF : Turns OFF the function.</li> <li>• ON : Outputs the status.</li> </ul>
<b>RS-232C Function</b>	<b>CI-V</b>
Select [RS-232C] connector output data format from CI-V and Decode.	<ul style="list-style-type: none"> <li>• CI-V : Outputs data in CI-V format. (default)</li> <li>• Decode : Outputs decoded contents in ASCII code format.</li> </ul>
<b>Decode Baud Rate</b>	<b>9600</b>
Selects data transmission speed (Baud rate) when "Decode" is selected in "RS-232C Function" above; settings are 300, 1200, 4800, 9600 and 19200 bps. (default: 9600)	
<b>Keyboard Type</b>	<b>English</b>
Selects the connected keyboard type from Japanese, English, United Kingdom, French, French (Canadian), German, Portuguese, Portuguese (Brazilian), Spanish, Spanish (Latin American) and Italian. (default: English)	

## ■ Other set mode (continued)

<b>Keyboard Repeat Delay</b>	<b>250ms</b>
<p>Sets the time period for delay from 100 to 1000 milliseconds in 50 millisecond steps. (default: 250 milliseconds)</p> <p>When a key of the connected keyboard is held down for the set period, the character is input continuously.</p>	
<b>Keyboard Repeat Rate</b>	<b>10.9cps</b>
<p>Sets the repeating rate for the connected keyboard within 2.0 to 30.0 cps. (default: 10.9 cps) *cps=character per second</p> <p>When a key of the connected keyboard is held down, the character is repeatedly input with the set speed.</p> <ul style="list-style-type: none"> <li>• Available repeating rate 2.0, 2.1, 2.3, 2.5, 2.7, 3.0, 3.3, 3.7, 4.0, 4.3, 4.6, 5.0, 5.5, 6.0, 6.7, 7.5, 8.0, 8.6, 9.2, 10.0, 10.9, 12.0, 13.3, 15.0, 16.0, 17.1, 18.5, 20.0, 21.8, 24.0, 26.7, 30.0</li> </ul>	
<b>IP Address</b> (Valid after Reboot)	<b>192. 168. 0. 10</b>
<p>Sets IP address for the IC-7700 when connecting to your PC or LAN (Local Area Network) through the Ethernet connector.</p> <p>Turn the transceiver power OFF then ON to make the setting effective. See page 16-7 for details.</p>	
<b>Subnet Mask</b> (Valid after Reboot)	<b>255. 255. 255. 0 (24bit)</b>
<p>Sets subnet mask for the IC-7700 when connecting to your PC or LAN (Local Area Network) through the Ethernet connector.</p> <p>Turn the transceiver power OFF then ON to make the setting effective. See page 16-7 for details.</p>	
<b>Default Gateway</b> (Valid after Reboot)	 . . .
<p>Sets the default gateway of the router that you want to connect the IC-7700 to.</p> <p>Turn the transceiver power OFF then ON to make the setting effective.</p> <p>/// Only when you configure the remote control system using an optional RS-BA1 through the Internet, you need this setting.</p>	
<b>Network Control</b> (Valid after Reboot)	<b>OFF</b>
<p>Selects the remote control capability ON or OFF. (default : OFF)</p> <p>Turn the transceiver power OFF then ON to make the setting effective.</p> <p>/// Only when you configure the remote control system using an optional RS-BA1, you need this setting.</p>	
<b>Control Port (UDP)</b> (Valid after Reboot)	<b>50001</b>
<p>Sets the Control port of the IC-7700 by accessing from the remote station.</p> <p>Turn the transceiver power OFF then ON to make the setting effective.</p> <p>/// Only when you configure the remote control system using an optional RS-BA1, you need this setting.</p>	

## Other set mode (continued)

<b>Serial Port (UDP) (Valid after Reboot) 50002</b>	
<p>Sets the Serial port of the IC-7700 by accessing from the remote station.</p> <p>/// Only when you configure the remote control system using an optional RS-BA1, you need this setting.</p>	<p>Turn the transceiver power OFF then ON to make the setting effective.</p>
<b>Audio Port (UDP) (Valid after Reboot) 50003</b>	
<p>Sets the Audio port of the IC-7700 by accessing from the remote station.</p> <p>/// Only when you configure the remote control system using an optional RS-BA1, you need this setting.</p>	<p>Turn the transceiver power OFF then ON to make the setting effective.</p>
<b>Internet Access Line (Valid after Reboot) FTTH</b>	
<p>Selects the your internet access line type.</p> <p>/// Only when you configure the remote control system using an optional RS-BA1 through the Internet, you need this setting.</p>	<ul style="list-style-type: none"> <li>• FTTH : Fiber To The Home</li> <li>• ADSL/CATV : ADSL or Cable television</li> </ul> <p>Turn the transceiver power OFF then ON to make the setting effective.</p>
<b>Network User1 ID</b>	
<p>Register the Users ID to allow them to remotely access the IC-7700. The IC-7700 can register three users to Network User1 ID to Network User3 ID.</p> <p>/// Only when you configure the remote control system using an optional RS-BA1, you need this registration.</p> <p>The IC-7700 verifies the User ID and password when Remote stations attempt to access the transceiver. If the User ID or password is incorrect, the Remote station cannot access the transceiver.</p>	<ol style="list-style-type: none"> <li>1 Push [EDIT] [F-5] to enter the User ID Edit mode.</li> <li>2 Rotate the main dial to input a User ID of up to 16 characters. <ul style="list-style-type: none"> <li>• Push [ABC] (MF6) or [abc] (MF6) to toggle upper and lower case letters.</li> <li>• Push [123] (MF7) or [Symbol] (MF7) to toggle between numerals and symbols.</li> <li>• You cannot register the same ID with User2 or User3, if the ID is already registered.</li> <li>• Push [◀] [F-1] or [▶] [F-2] for cursor movement.</li> <li>• Push [DEL] [F-3] to delete the selected character.</li> </ul> </li> <li>3 Push [SET] [F-5] to set.</li> </ol>
<b>Password</b>	
<p>Register the password for the Network User1 ID.</p>	<ol style="list-style-type: none"> <li>1 Push [EDIT] [F-5] to enter the Password Edit mode.</li> <li>2 Rotate the main dial to input a Password of 8 to 16 characters, case-sensitive. <ul style="list-style-type: none"> <li>• At least two different characters must be used.</li> <li>• Push [ABC] (MF6) or [abc] (MF6) to toggle upper and lower case letters.</li> <li>• Push [123] (MF7) or [Symbol] (MF7) to toggle between numerals and symbols.</li> <li>• Push [◀] [F-1] or [▶] [F-2] for cursor movement.</li> <li>• Push [F-3•DEL] to delete the selected character.</li> </ul> </li> <li>3 Push [SET] [F-5] to set.</li> </ol>
<b>Administrator NO</b>	
<p>Selects the administrator setting YES or NO for Network User1 ID. (default: NO)</p>	<p>When this item is set to "YES," the Remote station can terminate a connection between another Remote station and the IC-7700.</p>

## ■ Other set mode (continued)

<b>Network User2 ID</b>	
<p>Register the Users ID to allow them to remotely access the IC-7700. The IC-7700 can register three users to Network User1 ID to Network User3 ID.</p> <p>/// Only when you configure the remote control system using an optional RS-BA1, you need this registration.</p>	<p>See the Network User1 ID on the previous page for setting details.</p> <ul style="list-style-type: none"> <li>You cannot register the same ID with User1 or User3, if the ID is already registered.</li> </ul>
<b>Password</b>	
<p>Register the password for the Network User2 ID.</p>	<p>See the Password of Network User1 ID on the previous page for setting details.</p>
<b>Administrator</b> <span style="float: right;"><b>NO</b></span>	
<p>Selects the administrator setting YES or NO for Network User2 ID. (default: NO)</p>	<p>When this item is set to "YES," the Remote station can terminate a connection between another Remote station and the IC-7700.</p>
<b>Network User3 ID</b>	
<p>Register the Users ID to allow them to remotely access the IC-7700. The IC-7700 can register three users to Network User1 ID to Network User3 ID.</p> <p>/// Only when you configure the remote control system using an optional RS-BA1, you need this registration.</p>	<p>See the Network User1 ID on the previous page for setting details.</p> <ul style="list-style-type: none"> <li>You cannot register the same ID with User1 or User2, if the ID is already registered.</li> </ul>
<b>Password</b>	
<p>Register the password for the Network User3 ID.</p>	<p>See the Password of Network User1 ID on the previous page for setting details.</p>
<b>Administrator</b> <span style="float: right;"><b>NO</b></span>	
<p>Selects the administrator setting YES or NO for Network User3 ID. (default: NO)</p>	<p>When this item is set to "YES," the Remote station can terminate a connection between another Remote station and the IC-7700.</p>
<b>Network Radio Name</b> <span style="float: right;"><b>IC-7700</b></span>	
<p>Enters the Network Radio name of up to 16 characters. The name displays on an RS-BA1's Remote Utility. <b>DO NOT</b> use the duplicated name on your network.</p> <p>/// Only when you configure the remote control system using an optional RS-BA1, you need this registration.</p>	<ol style="list-style-type: none"> <li>Push [EDIT] [F-5] to enter the Network Radio Name Edit mode.</li> <li>Rotate the main dial to input a Network Radio Name of up to 16 characters. <ul style="list-style-type: none"> <li>Push [ABC] (MF6) or [abc] (MF6) to toggle upper and lower case letters.</li> <li>Push [123] (MF7) or [Symbol] (MF7) to toggle between numerals and symbols.</li> <li>Push [◀] [F-1] or [▶] [F-2] for cursor movement.</li> <li>Push [DEL] [F-3] to delete the selected character.</li> </ul> </li> <li>Push [SET] [F-5] to set.</li> </ol>

■ Other set mode (continued)

<p><b>Network AF Sample Rates</b></p> <p>Selects the limitation of the received audio sampling rate that Remote stations can adjust.</p> <p>8 kHz, 12 kHz, 16 kHz, 24 kHz and 48 kHz are selectable. (default: 16 kHz)</p>	<p><b>8kHz, 12kHz, 16kHz</b></p> <p>Higher sampling rates will improve the audio quality. However, they also increase the amount of data, which can cause voice delay or jumpiness, depending on the network condition.</p> <p>Lower sampling rates will decrease the audio quality. However, they also decrease the amount of data.</p>
<p><b>Codecs</b></p> <p>Sets the received audio codecs that Remote stations can adjust.</p>	<p><b>LPCM 8bit, u-law 8bit, LPCM 16bit</b></p> <p>LPCM 8 bit, u-law 8 bit and LPCM 16 bit are selectable. (default: LPCM 8bit, u-law 8bit, LPCM 16bit)</p>
<p><b>Network MOD Use</b></p> <p>Selects whether or not to allow Remote stations to send the modulation audio. (default : ON)</p>	<p><b>ON</b></p> <ul style="list-style-type: none"> <li>• ON: The Remote stations send the modulation audio.</li> <li>• OFF: The Remote stations do not send the modulation audio.</li> </ul>
<p><b>Sample Rates</b></p> <p>Selects the limitation of the modulation audio sampling rate that Remote stations can adjust.</p> <p>8 kHz, 12 kHz, 16 kHz, 24 kHz and 48 kHz are selectable. (default: 8 kHz)</p>	<p><b>8kHz</b></p> <p>Higher sampling rates will improve the audio quality. However, they also increase the amount of data, which can cause voice delay or jumpiness, depending on the network condition.</p> <p>Lower sampling rates will decrease the audio quality. However, they also decrease the amount of data.</p>
<p><b>Codecs</b></p> <p>Sets the transmit audio codecs that Remote stations can select.</p>	<p><b>LPCM 8bit, u-law 8bit, LPCM 16bit</b></p> <p>LPCM 8 bit, u-law 8 bit and LPCM 16 bit are selectable. (default: LPCM 8bit, u-law 8bit, LPCM 16bit)</p>



## ■ USB-Memory set menu

### ◇ USB-Memory set screen arrangement

#### • USB-Memory set menu

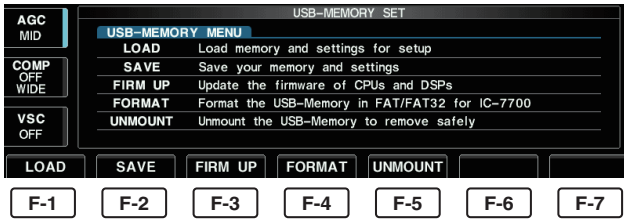

The USB flash drive is not supplied by Icom.

#### • Setting load screen (p. 12-26)

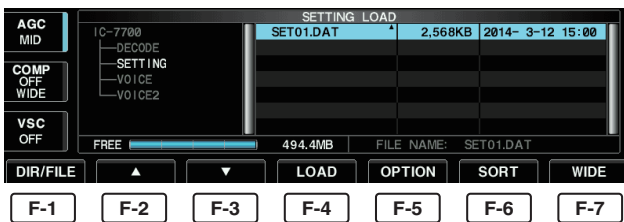

#### • Firmware update (p. 16-4)

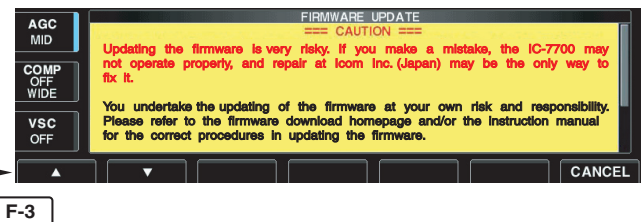

#### • Load option set mode (p. 12-25)

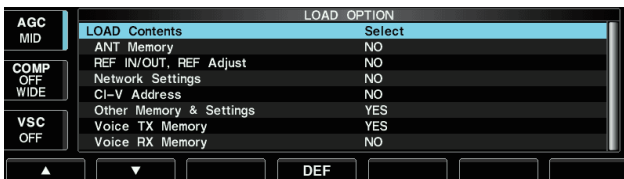

#### • Format menu (p. 12-30)

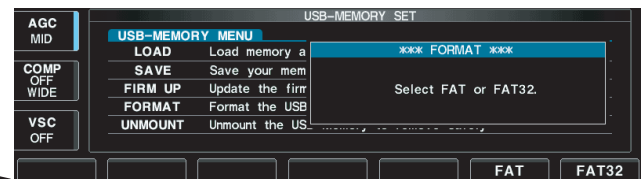

#### • Setting save screen (p. 12-26)

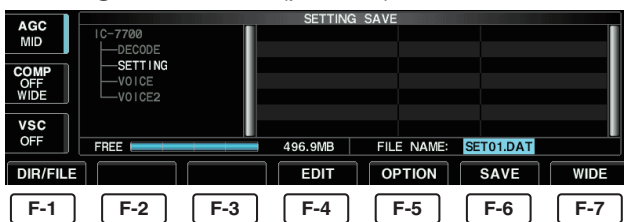

#### • Unmount USB flash drive (p. 12-29)

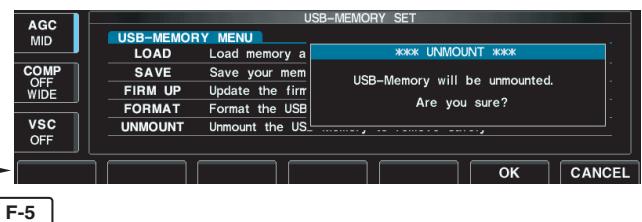

#### • Save option set mode (p. 12-24)

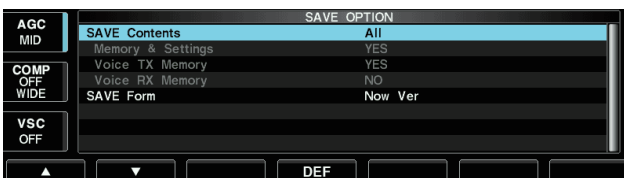

## ◇ Save option set mode

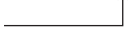
<b>SAVE Contents</b>	<b>All</b>
Selects file save condition from All and Select. (default: All)	<ul style="list-style-type: none"> <li>• All : Saves all the following contents.</li> <li>• Select : Saves the selected contents only.</li> </ul>
<b>Memory &amp; Settings</b>	<b>YES</b>
This setting is fixed "YES."	<ul style="list-style-type: none"> <li>• YES : Saves memory channel contents and settings of set modes.</li> </ul>
<b>Voice TX Memory</b>	<b>YES</b>
Selects the voice TX message save condition from YES and NO. (default: YES)	<ul style="list-style-type: none"> <li>• YES : Saves the voice TX message.</li> <li>• NO : Does not save.</li> </ul>
<b>Voice RX Memory</b>	<b>NO</b>
Selects the voice RX message save condition from YES and NO. (default: NO)	<ul style="list-style-type: none"> <li>• YES : Saves the voice RX message.</li> <li>• NO : Does not save.</li> </ul>
<b>SAVE Form</b>	<b>Now Ver</b>
Selects file saving format between "Now Ver" and "Old Ver." (default: Now Ver)	<ul style="list-style-type: none"> <li>• Now Ver : Saves the file in the firmware version format currently being used.</li> <li>• Old Ver : Saves the file in the firmware version format that is indicated in brackets.</li> </ul>
<p>Previous versions will be retained, and selectable in "Old Ver," and indicated in brackets.</p> <hr/> <p><b>For your information:</b> The current IC-7700 firmware version number can be confirmed when turning the power ON and is displayed in the bottom right corner of the function display, as shown below.</p>	<p><b>NOTE:</b> You cannot write setting file that is saved in the current version format to an older firmware version IC-7700.</p>
	
<p>Firmware version number is displayed here </p>	

## ◇ Load option set mode

<b>Load Contents</b>	<b>Select</b>
Selects file load condition from All and Select. (default: Select)	<ul style="list-style-type: none"> <li>• All : Loads and sets the all following contents.</li> <li>• Select : Loads and sets the selected contents only.</li> </ul>
<b>ANT Memory</b>	<b>NO</b>
Selects the antenna memory setting loading condition from YES and NO. (default: NO).	<ul style="list-style-type: none"> <li>• YES : Loads and sets the antenna memory.</li> <li>• NO : Use the original antenna memory setting.</li> </ul>
<b>REF IN/OUT, REF Adjust</b>	<b>NO</b>
Selects the reference signal setting load condition from YES and NO. (default: NO).	<ul style="list-style-type: none"> <li>• YES : Loads and sets the reference signal setting.</li> <li>• NO : Use the original reference signal setting.</li> </ul>
<b>Network Settings</b>	<b>NO</b>
Selects the Network settings loading condition from YES and NO. (default: NO).	<ul style="list-style-type: none"> <li>• YES : Loads and sets the Network settings.</li> <li>• NO : Use the original Network settings.</li> </ul>
<b>CI-V Address</b>	<b>NO</b>
Selects the CI-V address setting load condition from YES and NO. (default: NO).	<ul style="list-style-type: none"> <li>• YES : Loads and sets the CI-V address setting.</li> <li>• NO : Use the original CI-V address setting.</li> </ul>
<b>Other Memory &amp; Settings</b>	<b>YES</b>
This setting is fixed "YES."	<ul style="list-style-type: none"> <li>• YES : Loads and sets memory channel contents and other settings.</li> </ul>
<b>Voice TX Memory</b>	<b>YES</b>
Selects the voice TX message load condition from YES and NO. (default: YES).	<ul style="list-style-type: none"> <li>• YES : Loads and sets voice TX message.</li> <li>• NO : Use the original voice TX message.</li> </ul>
<b>Voice RX Memory</b>	<b>NO</b>
Selects the voice RX message load condition from YES and NO. (default: NO).	<ul style="list-style-type: none"> <li>• YES : Loads and sets voice RX message.</li> <li>• NO : Use the original voice RX message.</li> </ul>

## File saving

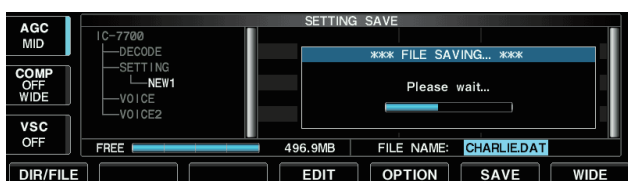
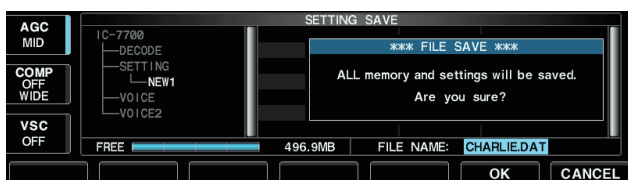
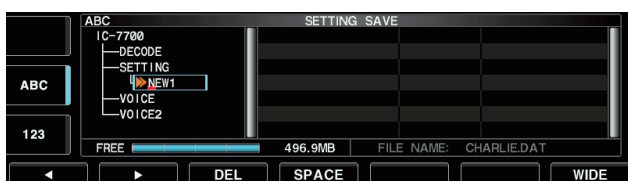
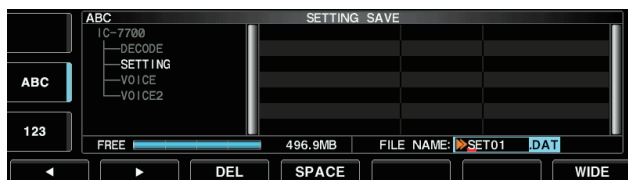
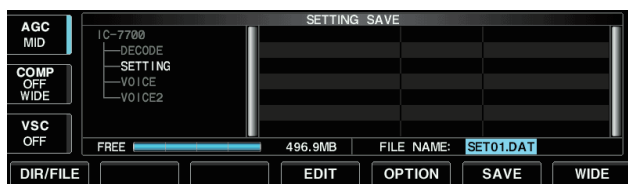
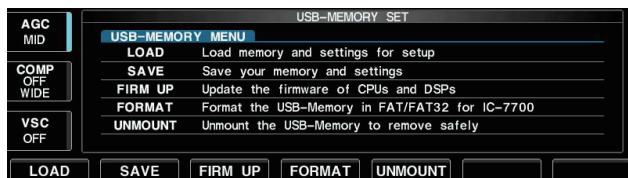
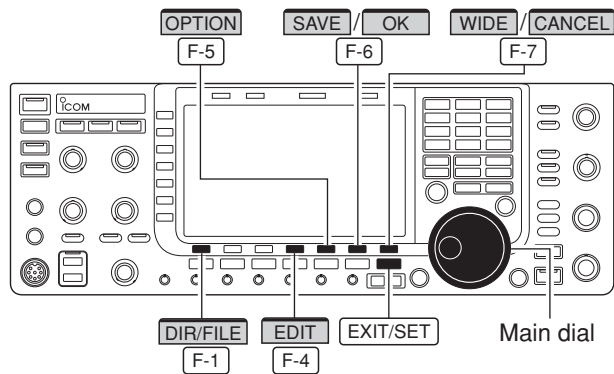

When a PC keyboard is connected to the [USB] connector on the front panel, the file name can also be edited from the keyboard.

Memory channel contents, set mode settings, etc. can be saved into the USB flash drive for backup.

- ① During set mode menu screen display, push [USB] [F-7] to select USB-Memory set menu screen.
- ② Push [SAVE] [F-2] to select setting save screen.
- ③ Change the following conditions if desired.

### • File name:

- ① Push [EDIT] [F-4] to select file name edit condition.
  - Push [DIR/FILE] [F-1] several times to select the file name, if necessary.
- ② Push [ABC] (MF6), [123] (MF7) or [Symbol] (MF7) to select the character group, then rotate the main dial to select the character.
  - [ABC] (MF6): A to Z (capital letters); [123] (MF7): 0 to 9 (numerals); [Symbol] (MF7): ! # \$ % & ' ^ - ( ) { } \_ ~ @ can be selected.
  - Push [◀] [F-1] to move the cursor left, push [▶] [F-2] to move the cursor right, push [DEL] [F-3] to delete a character and push [SPACE] [F-4] to insert a space.
- ③ Push [EXIT/SET] to set the file name.

### • Save option

- ① Push [OPTION] [F-5] to enter save option set mode.
- ② Push [▲] [F-1] or [▼] [F-2] to select the item, then rotate the main dial to select the desired setting. (See page 12-24 for details.)
  - "Text" is the default setting.
  - Hold down [DEF] [F-4] for 1 second to select the default setting.
- ③ Push [EXIT/SET] to return to the previous display.

### • Saving location

- ① Push [DIR/FILE] [F-1] to select tree view screen.
- ② Select the desired directory or folder in the USB flash drive.
  - Push [◀▶] [F-4] to select the upper directory.
  - Push [▲] [F-2] or [▼] [F-3] to select folder in the same directory.
  - Hold down [◀▶] [F-4] for 1 second to select a folder in the directory.
  - Push [REN/DEL] [F-5] to rename the folder.
  - Hold down [REN/DEL] [F-5] for 1 second to delete the folder.
  - Hold down [MAKE] [F-6] for 1 second to making a new folder. (Edit the name with the same manner as the "• File name" above.)
- ③ Push [DIR/FILE] [F-1] twice to select the file name.

- ④ Push [SAVE] [F-6].
  - Confirmation screen appears.
- ⑤ Push [OK] [F-6] to save.
  - After saving is completed, return to USB flash drive set menu automatically.

## ■ File loading

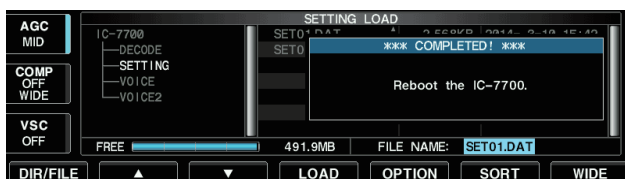
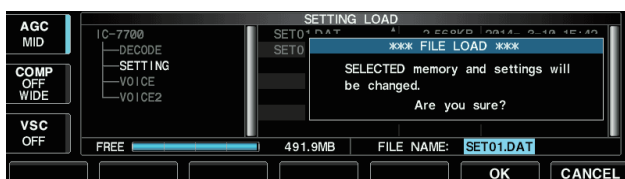
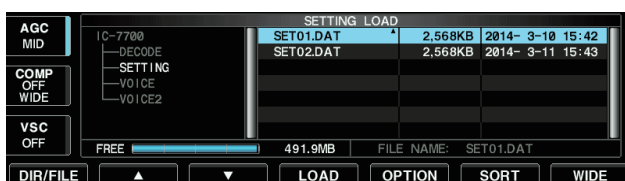
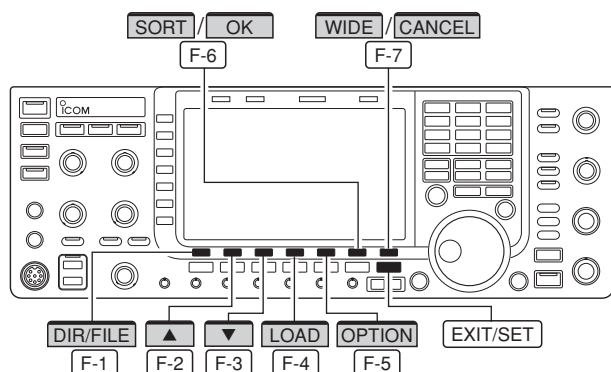

By loading the saved setting file from the USB flash drive, you can easily set up another IC-7700—several operators settings can easily be applied to one IC-7700.

- ① During set mode menu screen display, push [USB] [F-7] to select USB-Memory set menu screen.
- ② Push [LOAD] [F-1] to select setting load screen.
  - The indicator above the USB connectors and “USB” indicator on the display blink.
  - After the USB flash drive contents are displayed, the indicators stop blinking.
- ③ Push [OPTION] [F-5] to select load option set mode, then set the desired loading conditions, if desired.
  - See page 12-25 for details.
- ④ Push [▲] [F-2] or [▼] [F-3] to select the desired setting file.
- ⑤ Push [LOAD] [F-4].
  - Confirmation screen appears.
- ⑥ Push [OK] [F-6] to starts loading.
  - After the loading is completed, the message dialog, “Reboot the IC-7700,” appears.
- ⑦ Turn the transceiver power OFF then ON to make the setting effective.

## ■ Changing a file name

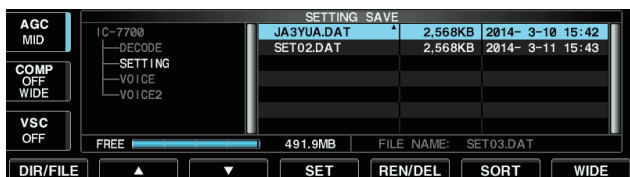
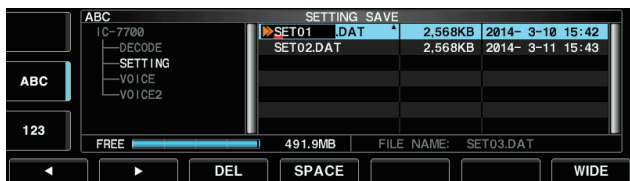
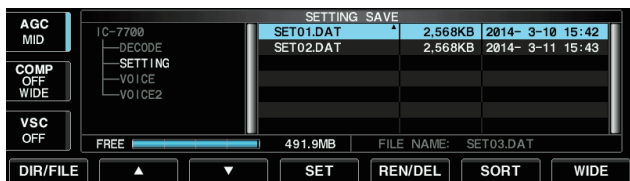
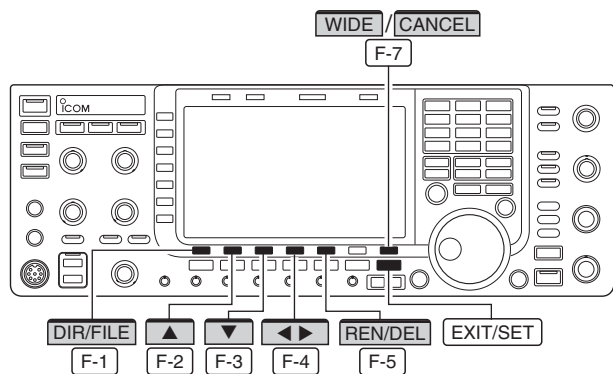

When a PC keyboard is connected to the [USB] connector on the front panel, the file name can also be edited from the keyboard.

The file name, saved in the USB flash drive, can be re-named from the transceiver as desired.

- ① During setting save screen display, push [DIR/FILE] [F-1] to select tree view screen.
  - Push [▲] [F-2] or [▼] [F-3] to select the desired folder.
  - “DECODE,” “SETTING” and “VOICE” folders are available as the default.
  - After the folder is selected, hold down [◀▶] [F-4] for 1 second to display content folder(s), if available.
- ② Push [DIR/FILE] [F-1] to select file list screen.
- ③ Push [▲] [F-2] or [▼] [F-3] to select the desired file.
- ④ Push [REN/DEL] [F-5] momentarily to select the file name edit condition.
- ⑤ Push [ABC] (MF6), [123] (MF7) or [Symbol] (MF7) to select the character group, then rotate the main dial to select the character.
  - [ABC] (MF6): A to Z (capital letters); [123] (MF7): 0 to 9 (numerals); [Symbol] (MF7): ! # \$ % & ‘ ` ^ - ( ) { } \_ ~ @ can be selected.
  - Push [◀] [F-1] to move the cursor left, push [▶] [F-2] to move the cursor right, push [DEL] [F-3] to delete a character and push [SPACE] [F-4] to insert a space.
  - Pushing the transceiver’s keypad, [0]–[9], can also enter numerals.
- ⑥ Push [EXIT/SET] to set the file name.

## ■ Deleting a file

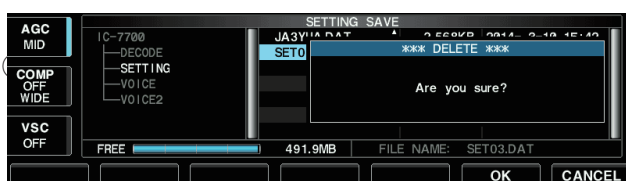
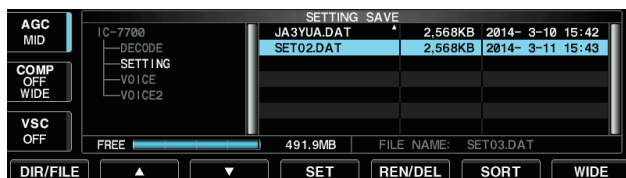

**RECOMMENDATION!** Deleting the setting file is irreversible. Confirm the contents before deleting a setting file!

- ① During setting save screen display, push [DIR/FILE] [F-1] to select tree view screen.
  - Push [▲] [F-2] or [▼] [F-3] to select the desired folder.
  - “DECODE,” “SETTING” and “VOICE” folders are available as the default.
  - After the folder is selected, hold down [◀▶] [F-4] for 1 second to display content folder(s), if available.
- ② Push [DIR/FILE] [F-1] to select file list screen. Push [▲] [F-2] or [▼] [F-3] to select the desired file to be deleted.
- ④ Hold down [REN/DEL] [F-5] for 1 second.
  - Confirmation screen appears.
- ⑤ Push [OK] [F-6] to delete.
  - After the deleting, return to setting save screen automatically.

## ■ Unmounting USB flash drive

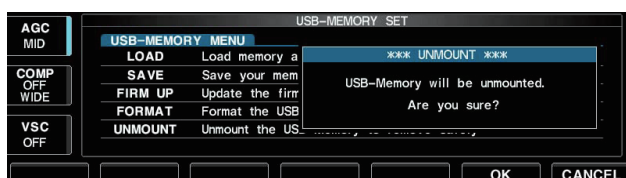

**CAUTION:** When removing the USB flash drive, unmount operation is recommended. If you do not unmount the memory in this case, data in the USB memory may be corrupted.

- ① Hold down [UNMOUNT] [F-6] for 1 second.
  - Confirmation screen appears.
- ② Push [OK] [F-6] to unmount the USB flash drive.
- ③ After “USB” indication disappears, remove the USB flash drive.

## ■ Formatting USB flash drive

Saved data in the USB flash drive can be erased.

**IMPORTANT!** Formatting erases all saved data in the USB flash drive. Making a backup file on your PC is recommended.

- ① During USB-Memory set menu display, hold down [FORMAT] [F-4] for 1 second.
  - Confirmation screen appears.
- ② Push [FAT] [F-6] or [FAT32] [F-7] to select the format type, FAT or FAT32.
  - Confirmation screen appears.
- ③ Push [OK] [F-6] to format.
  - Push [CANCEL] [F-7] to cancel.
- ④ Returns to USB-Memory set menu automatically.

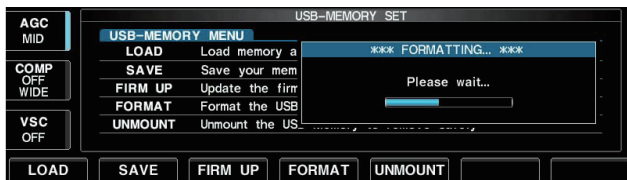
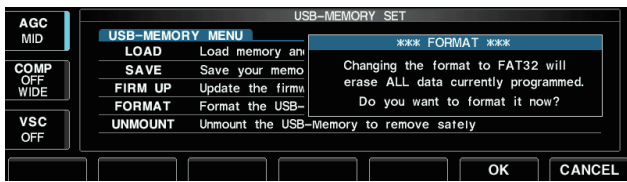

**NOTE:** If no USB flash drive is inserted and [FORMAT] [F-4] is selected as in step ①, an error message appears.



■ Troubleshooting .....	13-2
◇ Transceiver power .....	13-2
◇ Transmit and receive .....	13-2
◇ Scanning .....	13-3
◇ Display .....	13-3
◇ Format USB flash drive .....	13-3
■ Main dial brake adjustment .....	13-3
■ SWR reading .....	13-4
■ Screen type and font selections .....	13-4
■ Frequency calibration (approximate) .....	13-5
■ Opening the transceiver's case .....	13-6
■ Clock backup battery replacement .....	13-6
■ Fuse replacement .....	13-7
■ Resetting the CPU .....	13-7
■ About protection indications .....	13-8
■ Screen Saver Function .....	13-8

## ■ Troubleshooting

The following chart is designed to help you correct problems which are not equipment malfunctions. If you are unable to locate the cause of a problem or solve it through the use of this chart, contact your nearest Icom Dealer or Service Center.

### ◇ Transceiver power

PROBLEM	POSSIBLE CAUSE	SOLUTION	REF.
Power does not come on when the [POWER] switch is pushed.	<ul style="list-style-type: none"> <li>• Power cable is improperly connected.</li> <li>• The internal power supply is turned OFF.</li> <li>• Circuit breaker is tripped.</li> </ul>	<ul style="list-style-type: none"> <li>• Re-connect the AC power cable correctly.</li> <li>• Turn the internal power supply ON.</li> <li>• Check for the cause, then re-set the circuit breaker.</li> </ul>	<p>p. 2-5 p. 3-2 —</p>

### ◇ Transmit and receive

PROBLEM	POSSIBLE CAUSE	SOLUTION	REF.
No sounds from the speaker.	<ul style="list-style-type: none"> <li>• Volume level is too low.</li> <li>• The squelch is closed.</li> <li>• The transceiver is in transmit.</li> </ul>	<ul style="list-style-type: none"> <li>• Rotate [AF] clockwise to obtain a suitable listening level.</li> <li>• Turn [SQL] to 10 o'clock position to open the squelch.</li> <li>• Push [TRANSMIT] to receive or check the SEND line of an external unit, if connected.</li> </ul>	<p>p. 3-9 p. 3-9 p. 3-12</p>
Sensitivity is too low, and only strong signals are audible.	<ul style="list-style-type: none"> <li>• The antenna is not connected properly.</li> <li>• The antenna for another band is selected.</li> <li>• The antenna is not properly tuned.</li> <li>• The attenuator is activated.</li> </ul>	<ul style="list-style-type: none"> <li>• Re-connect to the antenna connector.</li> <li>• Select an antenna suitable for the operating frequency.</li> <li>• Hold down [TUNER] for 1 second to manually tune the antenna.</li> <li>• Push [ATT] (MF4) several times to select "ATT OFF."</li> </ul>	<p>— p. 10-2 p. 10-6 p. 5-10</p>
Received audio is unclear or distorted.	<ul style="list-style-type: none"> <li>• Wrong operating mode is selected.</li> <li>• PBT function is activated.</li> <li>• Noise blanker is turned ON when receiving a strong signal.</li> <li>• Preamp is activated.</li> <li>• The noise reduction is activated and the [NR] control is too far clockwise.</li> </ul>	<ul style="list-style-type: none"> <li>• Select a suitable operating mode.</li> <li>• Hold down [PBT-CLR] for 1 second to reset the function.</li> <li>• Push [NB] to turn the noise blanker OFF.</li> <li>• Push [P.AMP] (MF3) once or twice to turn the function OFF.</li> <li>• Set the [NR] control for maximum readability.</li> </ul>	<p>p. 3-8 p. 5-13 p. 5-17 p. 5-10 p. 5-18</p>
The [ANT] switch does not function	<ul style="list-style-type: none"> <li>• The antenna switch has not been activated.</li> </ul>	<ul style="list-style-type: none"> <li>• Set the antenna switch in set mode to "Auto" or "Manual."</li> </ul>	p. 10-4
Transmitting is impossible.	<ul style="list-style-type: none"> <li>• The operating frequency is not inside a ham band.</li> </ul>	<ul style="list-style-type: none"> <li>• Set the frequency to be in a ham band.</li> </ul>	p. 3-5
Output power is too low.	<ul style="list-style-type: none"> <li>• [RF PWR] is set too far counterclockwise</li> <li>• [DRIVE] is set too far counterclockwise</li> <li>• [MIC] is set too far counterclockwise</li> <li>• The antenna for another band is selected.</li> <li>• The antenna is not properly tuned.</li> </ul>	<ul style="list-style-type: none"> <li>• Rotate [RF PWR] clockwise.</li> <li>• Set [DRIVE] to a suitable position.</li> <li>• Set [MIC] to a suitable position.</li> <li>• Select an antenna suitable for the operating frequency.</li> <li>• Hold down [TUNER] for 1 second to manually tune the antenna.</li> </ul>	<p>p. 3-12 p. 3-13 p. 3-12 p. 10-2 p. 10-6</p>
No contact can be made with another station.	<ul style="list-style-type: none"> <li>• RIT or ΔTX function is activated.</li> <li>• Split frequency function is activated.</li> </ul>	<ul style="list-style-type: none"> <li>• Push [RIT] or [ΔTX] to turn the function OFF.</li> <li>• Push [SPLIT] to turn the function OFF.</li> </ul>	<p>pp. 5-11, 6-4 p. 6-6</p>
Transmit signal is unclear or distorted.	<ul style="list-style-type: none"> <li>• [MIC] is set too far clockwise</li> </ul>	<ul style="list-style-type: none"> <li>• Set [MIC] to a suitable position.</li> </ul>	p. 3-12
Repeater cannot be accessed.	<ul style="list-style-type: none"> <li>• Split frequency function is not activated.</li> <li>• Programmed subaudible tone frequency is wrong.</li> </ul>	<ul style="list-style-type: none"> <li>• Push [SPLIT] to to turn the function ON</li> <li>• Reset the frequency using set mode.</li> </ul>	<p>p. 6-6 p. 4-33</p>

◇ Scanning

PROBLEM	POSSIBLE CAUSE	SOLUTION	REF.
Programmed scan does not stop.	• Squelch is open.	• Set [SQL] to the threshold point.	p. 3-9
Programmed scan does not start.	• The same frequencies have been programmed in scan edge memory channels P1 and P2.	• Program different frequencies in scan edge memory channel P1 and P2.	p. 8-3
Memory scan does not start	• 2 or more memory channels have not been programmed.	• Program more than 2 memory channels.	p. 8-3
Select memory scan does not start	• 2 or more memory channels have not been designated as select channels.	• Designate more than 2 memory channels as select channels for the scan.	p. 9-7

◇ Display

PROBLEM	POSSIBLE CAUSE	SOLUTION	REF.
The displayed frequency does not change properly.	• The dial lock function is activated.	• Push [LOCK] to turn the function OFF.	p. 5-18
	• A set mode screen is selected.	• Push [EXIT/SET] several times to exit the set mode screen.	p. 12-2
	• The internal CPU has malfunctioned.	• Reset the CPU.	p. 13-7

◇ Format USB flash drive

PROBLEM	POSSIBLE CAUSE	SOLUTION	REF.
Format error appears when formatting in FAT32	• The inserted USB flash drive capacity is smaller than 64 MB.	• Insert a USB flash drive larger than 64 MB or select the FAT format.	p. 12-30
Format error appears when formatting in FAT	• The inserted USB flash drive capacity is larger than 2 GB.	• Insert a USB flash drive smaller than 2 GB or select the FAT32 format.	p. 12-30

■ Main dial brake adjustment

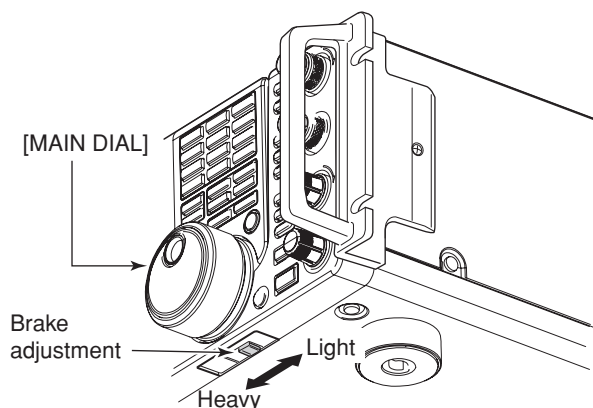

The tension of the main dial may be adjusted to suit your preference.

The brake adjustment is located on the bottom side of the front panel. See the figure at left.

Slide the brake adjustment to a comfortable tension level while turning the dial continuously and evenly in one direction.

## SWR reading

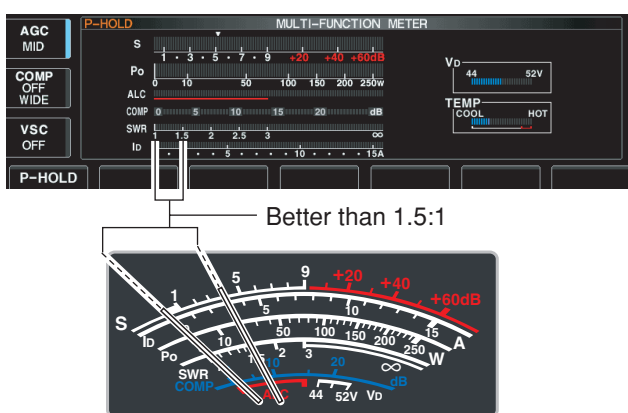
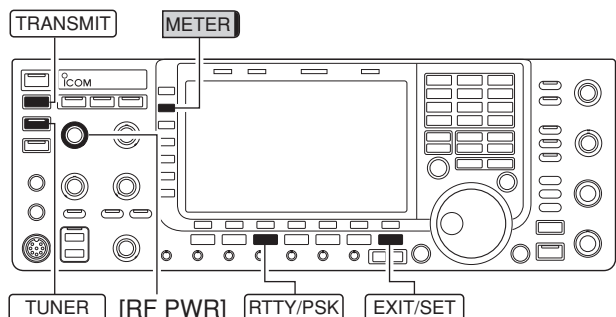

The SWR meter indicates the SWR over the transmission line in all modes.

- ① Push **[TUNER]** to turn the antenna tuner OFF.
- ② Hold down **[METER]** for 1 second to display multi-function meter.
- ③ Push **[RTTY/PSK]** once or twice to select RTTY mode.
- ④ Push **[TRANSMIT]**.
- ⑤ Rotate **[RF PWR]** clockwise past the 12 o'clock position for more than 30 W output power.
- ⑥ Read the SWR on the SWR meter gage.
- ⑦ Push **[EXIT/SET]** to close multi-function meter.

▨ The built-in antenna tuner matches the transmitter to the antenna when the SWR is lower than 3 : 1.

## Screen type and font selections

- Screen image example—  
Display Type: B, Display Font: Slim



2 types of screen images and 5 types of frequency readout display fonts are available in the IC-7700.

- ① Push **[EXIT/SET]** several times to close multi-function screen, if necessary.
- ② Push **[SET] [F-7]** to select set mode menu screen.
- ③ Push **[DISP] [F-3]** to enter display set mode.
- ④ Push **[▲] [F-1]** or **[▼] [F-2]** to select “Display Type” item when selecting the screen image, select “Display Font” when selecting the frequency readout display font.
- ⑤ Rotate the main dial to select the desired screen image or font.
  - Screen image is selectable from A (Black back) and B (Blue back).
  - Basic (1), Basic (2), Italic, Round and Slim are available for the frequency readout font.
- ⑥ Push **[EXIT/SET]** twice to exit from display set mode.

## ■ Frequency calibration (approximate)

A very accurate frequency counter is required to calibrate the frequency of the transceiver. However, a rough check may be performed by receiving radio station WWV, WWVH, or other standard frequency signals.

**CAUTION:** The IC-7700 has been thoroughly adjusted and tested at the factory before being shipped. You should not have to re-calibrate it.

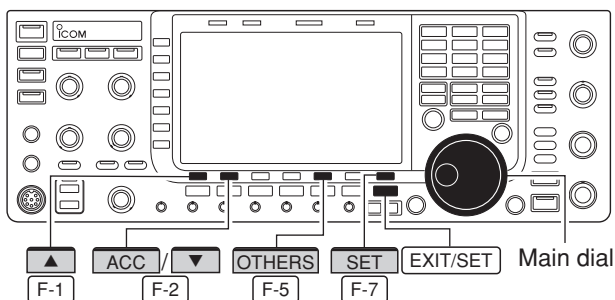

### • Calibration marker item

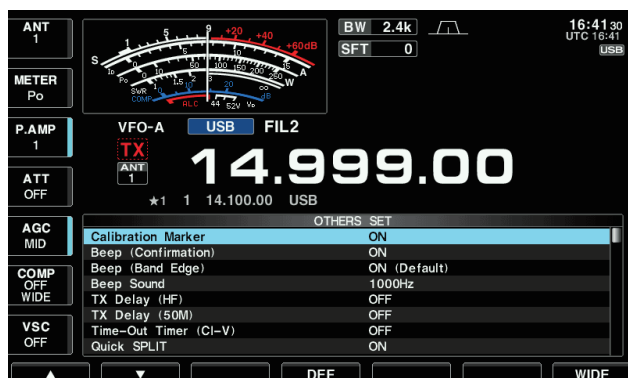

### • REF Adjust item

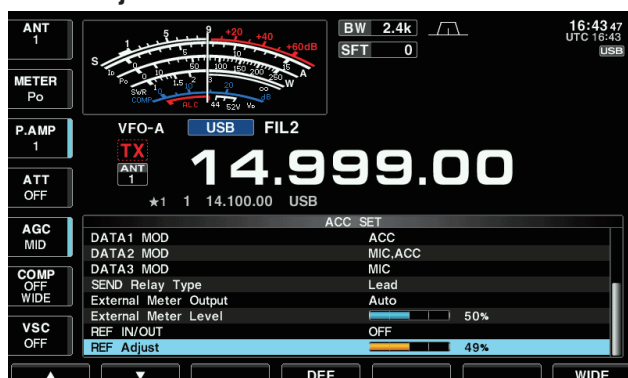

- ① Push **[SSB]** to select USB mode.
- ② Hold down **[PBT-CLR]** for 1 second to clear the PBT setting and make sure that the RIT/ $\Delta$ TX function is not activated.
- ③ Set the frequency to the standard frequency station minus 1 kHz.
  - When receiving WWV or WWVH (at 15.00000 MHz) as a standard frequency, set the operating frequency for 14.99900 MHz.
  - Other standard frequencies can be used.
- ④ Push **[EXIT/SET]** several times to close a multi-function screen, if necessary.
- ⑤ Push **[SET] [F-7]** to select set mode menu screen.
- ⑥ Push **[OTHERS] [F-5]** to enter Others set mode.
- ⑦ Push **[▲] [F-1]** several times to select the “Calibration Marker” item.
- ⑧ Rotate the main dial clockwise to turn the calibration marker ON.
- ⑨ Push **[EXIT/SET]** once to return to set mode menu screen.
- ⑩ Push **[ACC] [F-2]** to enter accessory set mode.
- ⑪ Push **[▼] [F-2]** several times to select the “REF Adjust” item.
- ⑫ Rotate the main dial to adjust for a zero beat with the received standard signal as shown at left.
  - Zero beat means that two signals are exactly the same frequency, resulting in a single tone being emitted.
- ⑬ Turn the calibration marker OFF in Others set mode.
- ⑭ Push **[EXIT/SET]** twice to exit set mode.

## ■ Opening the transceiver's case

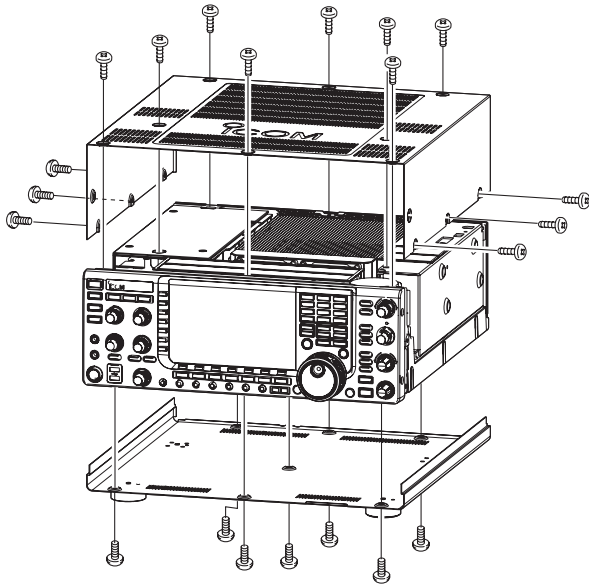

Follow the case opening procedures shown here when you want to replace the clock backup battery or internal fuse.

**⚠ WARNING! DISCONNECT** the AC power cable from the transceiver before performing any work on the transceiver. Otherwise, there is danger of electric shock and/or equipment damage.

**CAUTION:** The transceiver weighs approximately 22.5 kg (50 lb). Always have two people available to lift or turn over the transceiver.

- ① Remove the rack mounting handles from both sides. See page 2-3 for rack mounting handle detachment details.
- ② Remove the 8 screws from the top of the transceiver and the 6 screws from the sides, then lift up the top cover.
- ③ Turn the transceiver upside-down.

**CAUTION: NEVER HOLD THE MAIN DIAL OR ANY OTHER KNOBS** when the transceiver is being turned upside down. This may damage the transceiver.

- ④ Remove 7 screws from the bottom, then lift up the bottom cover.

## ■ Clock backup battery replacement

The IC-7700 has a Lithium backup battery (CR2032) inside for clock and timer functions. The usual life of the backup battery is approximately 2 years.

When the backup battery is discharged, the transceiver transmits and receives normally but cannot retain the current time.

**⚠ WARNING! DISCONNECT** the AC power cable from the AC outlet before removing the transceiver's cover.

- ① Remove the top cover as shown above.
- ② Replace the clock backup battery, located on the front panel as illustrated at left.
  - Make sure the battery polarity is correct.
- ③ Return the top cover to the original position.
- ④ Set the date and time in time set mode. (p. 11-2)

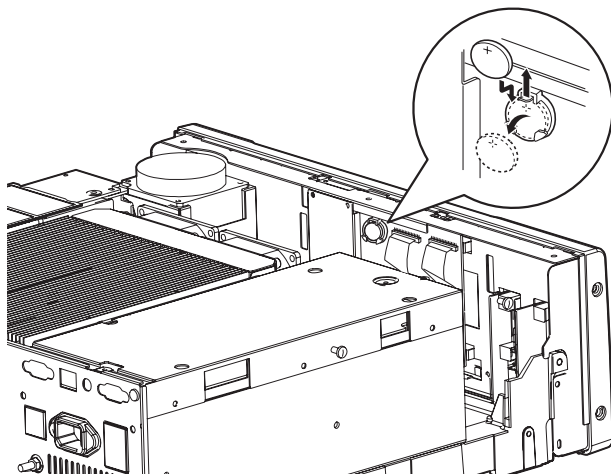

### For Users in California (U.S.A.)

This CR2032 Lithium Battery contains Perchlorate Material—special handling may apply.

See <http://www.dtsc.ca.gov/hazardouswaste/perchlorate>

## ■ Fuse replacement

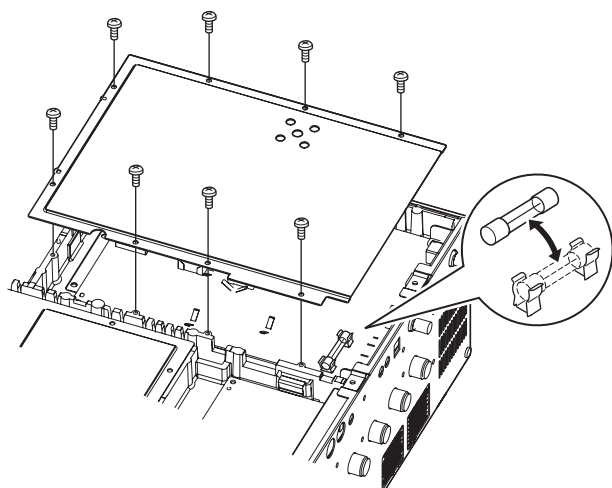

When no external DC output is available from [EXT DC] and ACC connectors, the internal fuse may be open. Replace the fuse in this case.

**⚠ WARNING! DISCONNECT** the AC power cable from the AC outlet before removing the transceiver's cover.

- ① Remove the bottom cover as shown left.
- ② Remove the 8 screws from the shield cover of the transceiver's bottom side.
- ③ Replace the open fuse with a new, properly rated one (FGB 2 A) as shown at left.
- ④ Return the inside cover and bottom cover and screws to the original position.

## ■ Resetting the CPU

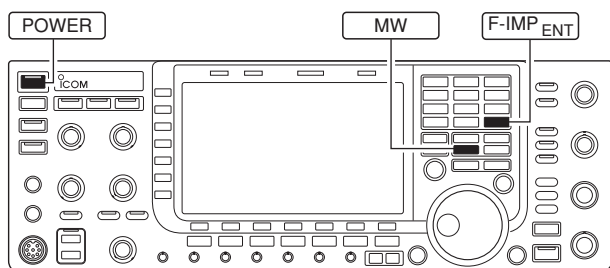

- ① Turn the main power switch on the rear panel ON.
  - Make sure the transceiver power is still OFF.
- ② While holding down [F-IMP ENT] and [MW], push [POWER] to turn ON the power.
  - The internal CPU is reset.
  - The CPU start-up takes approximately 5 seconds.
  - The transceiver displays its initial VFO frequencies when resetting is complete.
- ③ Correct the set mode settings after resetting, if desired.

**NOTE:** Resetting **CLEARs** all programmed contents in memory channels and returns programmed values in set mode to default values.

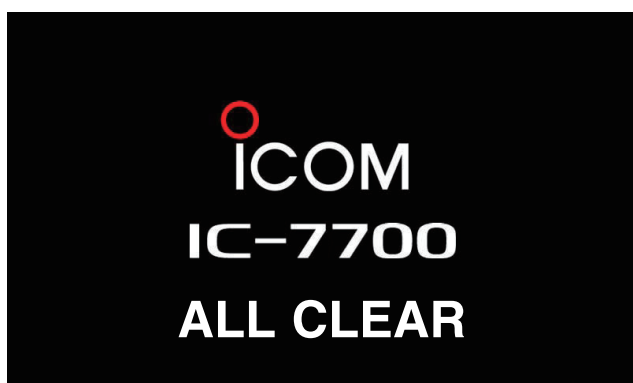

The transceiver cannot be reset in the standby mode. If the transceiver is so, release the standby mode.

- ① Push [POWER] to turn ON the power.
- ② Hold down [POWER] for 1 second to display the dialog box.

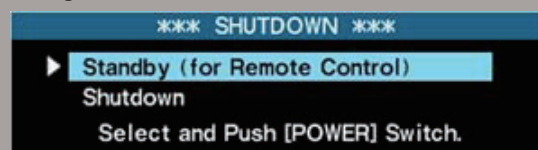

- ③ Rotate the main dial or push [▼] [F-2] to select "Shutdown."
- ④ Push [POWER] to turn OFF the power.
- ⑤ Perform from steps ② above.

## About protection indications

The IC-7700 has a 2-step protection function to protect the final power amplifiers.

The protector monitors the power amplifier temperature and activates when the temperature becomes extremely high.

- **Power down transmission**

Reduces the transmit output power to 100 W.

“LMT” appears beside the transmit indicator during transmit.

- **Transmission inhibit**

Deactivates the transmitter.

The transmit indicator is displayed in gray during transmit.

When the protector is activated, wait until the power amplifier cools down using the transceiver in stand-by or receive condition.

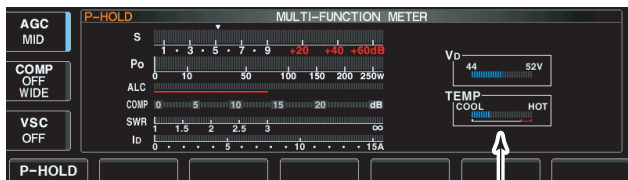

Check the temperature

**NOTE: DO NOT** turn the transceiver power OFF when the protector is ON. If you do, the cooling fan will not function and it will take longer to cool the transceiver.

The power amplifier temperature can be monitored in the multi-function meter, TEMP gauge.

## Screen saver function

The IC-7700 has a screen saver function to protect the LCD from the “burn-in” effect.

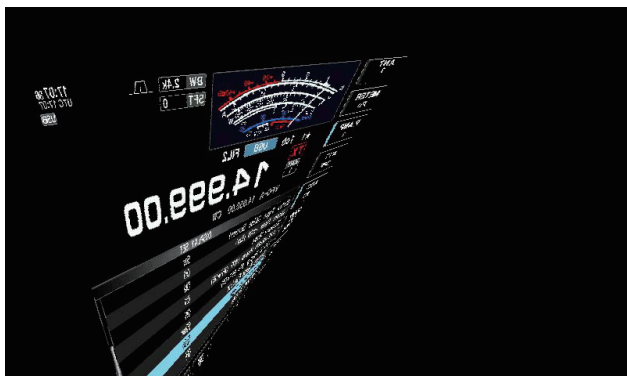
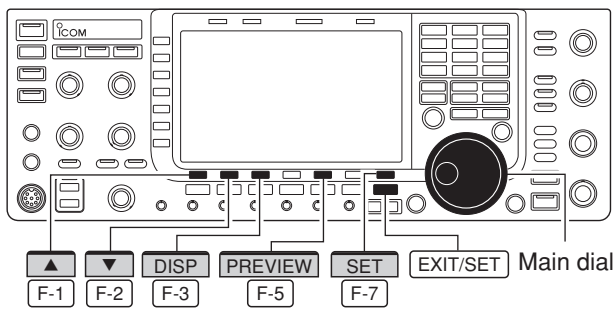

- ① Push [EXIT/SET] several times to close a multi-function screen, if necessary.
- ② Push [SET] [F-7] to select set mode menu screen.
- ③ Push [DISP] [F-3] to enter display set mode.
- ④ Push [▲] [F-1] or [▼] [F-2] several times to select the “Screen Saver Function” item.
- ⑤ Rotate the main dial to select the desired time period for the screen saver activation from 15, 30, 60 minutes and OFF.
  - Deactivate the screen saver with “OFF” selection.
- ⑥ Push [▼] [F-2] to select the “Screen Saver Type” item.
- ⑦ Rotate the main dial to select the screen saver type from “Bound,” “Rotation” and “Twist.”
  - Hold down [PREVIEW] [F-5] to display the pattern for your reference.
- ⑧ Push [EXIT/SET] twice to exit set mode.



- Remote jack (CI-V) information ..... 14-2
  - ◇ CI-V connection example ..... 14-2
  - ◇ Data format ..... 14-2
  - ◇ Command table ..... 14-3
  - ◇ Data contents description..... 14-9

## Remote jack (CI-V) information

### CI-V connection example

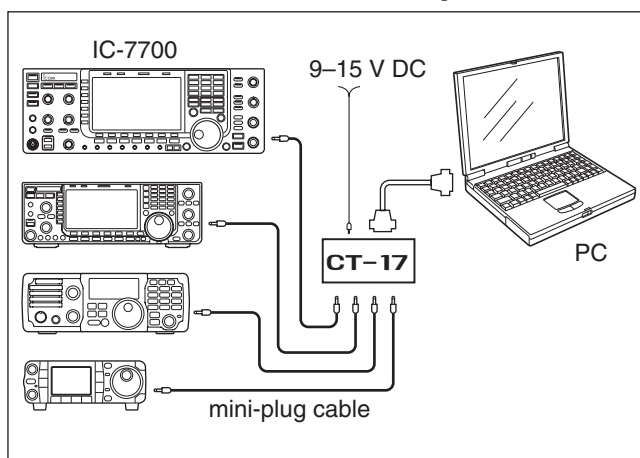

The transceiver can be connected through an optional CT-17 CI-V LEVEL CONVERTER to a PC equipped with an RS-232C port. The Icom Communications Interface-V (CI-V) controls the transceiver.

Up to 4 Icom CI-V transceivers or receivers can be connected to a PC equipped with an RS-232C port. See pages 12-17 and 12-18 for setting the CI-V condition using set mode.

### Data format

The CI-V system can be operated using the following data formats. Data formats differ according to command numbers. A data area or sub command is added for some commands.

#### Controller to IC-7700

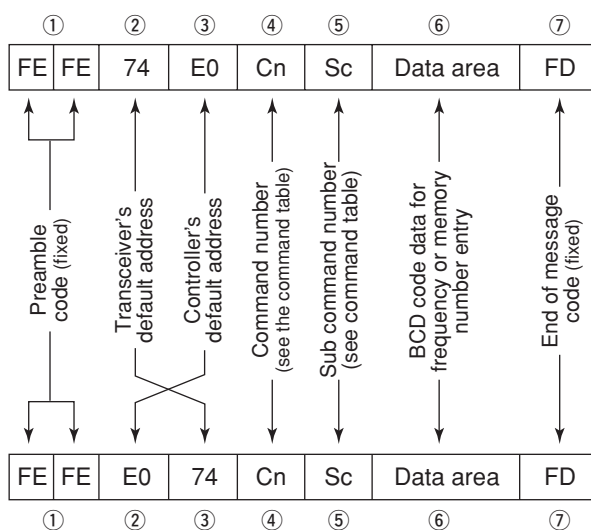

#### IC-7700 to controller

#### OK message to controller

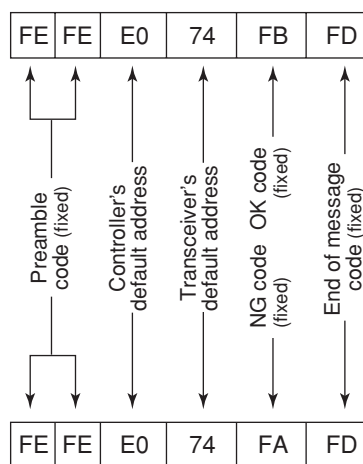

#### NG message to controller

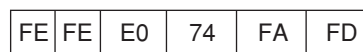

## ◇ Command table

Cmd.	Sub Cmd.	Data	Description
00		see p. 14-10	Send frequency data for transceiver
01		see p. 14-10	Send mode data for transceiver
02		see p. 14-12	Read band edge frequencies
03		see p. 14-10	Read operating frequency
04		see p. 14-10	Read operating mode
05		see p. 14-10	Set operating frequency
06		see p. 14-10	Operating mode selection
07			Select VFO mode
	00		Select VFO-A
	01		Select VFO-B
	A0		Equalize VFO-A and VFO-B
	B0		Exchange VFO-A and VFO-B
08			Select memory mode
		0001 to 0099	Select memory channel (0001=M-CH01, 0099=M-CH99)
		0100	Select program scan edge channel P1
		0101	Select program scan edge channel P2
09			Memory write
0A			Memory to VFO
0B			Memory clear
0E	00		Scan stop
	01		Programmed/memory scan start
	02		Programmed scan start
	03		$\Delta$ F scan start
	12		Fine programmed scan start
	13		Fine $\Delta$ F scan start
	22		Memory scan start
	23		Select memory scan start
	A1		Select $\Delta$ F scan span $\pm 5$ kHz
	A2		Select $\Delta$ F scan span $\pm 10$ kHz
	A3		Select $\Delta$ F scan span $\pm 20$ kHz
	A4		Select $\Delta$ F scan span $\pm 50$ kHz
	A5		Select $\Delta$ F scan span $\pm 100$ kHz
	A6		Select $\Delta$ F scan span $\pm 500$ kHz
	A7		Select $\Delta$ F scan span $\pm 1$ MHz
	B0		Set as non-select channel
	B1		Set as select channel (The previously set number by CI-V is set after turning power ON, or "1" is selected if no selection is performed.)
		01	Set as select channel "★1"
		02	Set as select channel "★2"
		03	Set as select channel "★3"
	B2	00	Set "ALL" for select memory scan
		01	Set "★1" for select memory scan
		02	Set "★2" for select memory scan
		03	Set "★3" for select memory scan
	D0		Set scan resume OFF
	D3		Set scan resume ON
0F			Read split setting (00=OFF, 01=ON)
	00		Turn the split function OFF
	01		Turn the split function ON

Cmd.	Sub Cmd.	Data	Description
10		00	Send/read 10 Hz (1 Hz) tuning step
		01	Send/read 100 Hz tuning step
		02	Send/read 1 kHz tuning step
		03	Send/read 5 kHz tuning step
		04	Send/read 9 kHz tuning step
		05	Send/read 10 kHz tuning step
		06	Send/read 12.5 kHz tuning step
		07	Send/read 20 kHz tuning step
		08	Send/read 25 kHz tuning step
11		00	Send/read attenuator OFF
		06	Send/read 6 dB attenuator
		12	Send/read 12 dB attenuator
		18	Send/read 18 dB attenuator
12	00	00/01	Select/read ANT1 selection (00=RX ANT OFF; 01=RX ANT ON)
	01	00/01	Select/read ANT2 selection (00=RX ANT OFF; 01=RX ANT ON)
	02	00/01	Select/read ANT3 selection (00=RX ANT OFF; 01=RX ANT ON)
	03	00	Select/read ANT4 selection (00=RX ANT OFF; fix)
13	00		Announce all data with voice synthesizer
	01		Announce frequency and S-meter level with voice synthesizer
	02		Announce receive mode with voice synthesizer
14	01	0000 to 0255	Send/read [AF] level (0000=max. CCW, 0255=max. CW)
	02	0000 to 0255	Send/read [RF] level (0000=max. CCW, 0255=max. CW)
	03	0000 to 0255	Send/read [SQL] level (0000=max. CCW, 0255=max. CW)
	05	0000 to 0255	Send/read [APF] position (0000=Pitch-550 Hz, 0128=Pitch, 0255=Pitch+550 Hz; 10 Hz steps)
	06	0000 to 0255	Send/read [NR] level (0000=0%, 0255=100%)
	07	0000 to 0255	Send/read inner [TWIN PBT] position (0000=max. CCW, 0128=center, 0255=max. CW)
	08	0000 to 0255	Send/read outer [TWIN PBT] position (0000=max. CCW, 0128=center, 0255=max. CW)
	09	0000 to 0255	Send/read CW pitch (0000=300 Hz, 0128=600 Hz, 0255=900 Hz; 5 Hz steps)
	0A	0000 to 0255	Send/read [RF POWER] level (0000=max. CCW, 0255=max. CW)
	0B	0000 to 0255	Send/read [MIC GAIN] level (0000=max. CCW, 0255=max. CW)
	0C	0000 to 0255	Send/read [KEY SPEED] level (0000=6WPM. CCW, 0255=48WPM)
	0D	0000 to 0255	Send/read [NOTCH] position (0000=max. CCW, 0128=center, 0255=max. CW)
	0E	0000 to 0255	Send/read [COMP] level (0000=0, 0255=10)
	0F	0000 to 0255	Send/read [DELAY] position (0000=2.0d, 0255=13.0d)

# 14 CONTROL COMMAND

## ◇ Command table (continued)

Cmd.	Sub Cmd.	Data	Description
14	11	0000 to 0255	Send/read [AGC] level (0000=max. CCW to 0255=max. CW)
	12	0000 to 0255	Send/read NB level (0000=0%, 0255=100%)
	13	0000 to 0255	Send/read [DIGI-SEL] position (0000=max. CCW to 0255=max. CW)
	14	0000 to 0255	Send/read DRIVE gain (0000=0%, 0255=100%)
	15	0000 to 0255	Send/read Monitor gain (0000=0%, 0255=100%)
	16	0000 to 0255	Send/read VOX gain (0000=0%, 0255=100%)
	17	0000 to 0255	Send/read Anti VOX gain (0000=0%, 0255=100%)
	18	0000 to 0255	Send/read [CONTRAST] level (0=max. CCW to 255=max. CW)
	19	0000 to 0255	Send/read BRIGHT level (0000=0%, 0255=100%)
15	01	00	Read squelch condition (squelch close)
		01	Read squelch condition (squelch open)
	02	0000 to 0255	Read S-meter level (0000=S0, 0120=S9, 0241=S9+60 dB)
	05	00	Read noise, S-meter squelch TSQ or VSC status (squelch close)
		01	Read noise, S-meter squelch TSQ or VSC status (squelch open)
	11	0000 to 0255	Read RF power meter (0000=0 W, 0143=100 W, 0212=200 W)
	12	0000 to 0255	Read SWR meter (0000=SWR1.0, 0048=SWR1.5, 0080=SWR2.0)
	13	0000 to 0255	Read ALC meter (0000=0, 0120=Max.)
	14	0000 to 0255	Read COMP meter (0000=0 dB, 0130=15 dB, 0241=30 dB)
15	0000 to 0255	Read VD meter (0151=44 V, 0180=48 V, 0211=52 V)	
16	0000 to 0255	Read ID meter (0000=0 A, 0165=10 A, 0241=15 A)	
16	02	00	Preamplifier OFF
		01	Preamplifier 1 ON
		02	Preamplifier 2 ON
	12	00	AGC OFF selection
		01	AGC FAST selection
		02	AGC MID selection
		03	AGC SLOW selection
	22	00	Noise blanker OFF
		01	Noise blanker ON
	32	00	Audio peak filter OFF
		01	Audio peak filter WIDE ON (320 Hz is selected when SHARP APF is set)
		02	Audio peak filter MID ON (160 Hz is selected when SHARP APF is set)
	40	00	Noise reduction OFF
		01	Noise reduction ON
		02	Noise reduction ON
	41	00	Auto notch function OFF
		01	Auto notch function ON
	42	00	Repeater tone OFF
01		Repeater tone ON	
43	00	Tone squelch OFF	
	01	Tone squelch ON	

Cmd.	Sub Cmd.	Data	Description
16	44	00	Speech compressor OFF
		01	Speech compressor ON
	45	00	Monitor function OFF
		01	Monitor function ON
	46	00	VOX function OFF
		01	VOX function ON
	47	00	BK-IN function OFF
		01	Semi BK-IN function ON
		02	Full BK-IN function ON
	48	00	Manual notch function OFF
		01	Manual notch function ON
	4C	00	VSC function OFF
		01	VSC function ON
	4D	00	AGC VR function OFF
01		AGC VR function ON	
4E	00	DIGI-SEL function OFF	
	01	DIGI-SEL function ON	
16	4F	00	Twin peak filter OFF
		01	Twin peak filter ON
	50	00	Dial lock function OFF
		01	Dial lock function ON
	53	00	ANT RX-I/O function OFF
		01	ANT RX-I/O function ON
	55	00	15 kHz roofing filter selection
		01	6 kHz roofing filter selection
		02	3 kHz roofing filter selection
	56	00	SHARP selection for DSP filter type
		01	SOFT selection for DSP filter type
	57	00	WIDE selection for manual notch width
		01	MID selection for manual notch width
		02	NAR selection for manual notch width
58	00	WIDE selection for SSB transmit bandwidth	
	01	MID selection for SSB transmit bandwidth	
	02	NAR selection for SSB transmit bandwidth	
17		see p. 14-12	Send CW messages*1
18	00		Turn ON the transceiver.
	01		Turn OFF the transceiver.*2
19	00		Read the transceiver ID
1A	00	see p. 14-13	Send/read memory contents
	01	see p. 14-10	Send/read band stacking register contents
	02	see p. 14-10	Send/read memory keyer contents
	03	00 to 49	Send/read the selected filter width (SSB, CW, PSK: 00=50 Hz to 40=3600 Hz; RTTY: 00=50 Hz to 31=2700 Hz; AM: 00=200 Hz to 49=10 kHz)
04	00 to 13		Send/read the selected AGC time constant (00=OFF, 01=0.1/0.3 sec., 13=6.0/8.0 sec.)

\*1 In the CW mode, if the [TRANSMIT] or an external TX switch is ON, or the Break-in function is ON, a message will be transmitted as CW code when you send it from your PC.

\*2 The power ON command (18 01) is available only when the transceiver is standby mode.

## ◇ Command table (continued)

Cmd.	Sub Cmd.	Data	Description
1A	05	0001	see p. 12-4 Send/read SSB RX HPF/LPF (HPF: 0=Through, 1=100 to 20=2000, LPF: 5=500 to 24=2400, 25=Through)
		0002	00 to 10 Send/read SSB RX Tone (Bass) level (00=-5 to 10=+5)
		0003	00 to 10 Send/read SSB RX Tone (Treble) level (00=-5 to 10=+5)
		0004	see p. 12-4 Send/read AM RX HPF/LPF (HPF: 00=Through, 01=100 to 20=2000, LPF: 5=500 to 24=2400, 25=Through)
		0005	00 to 10 Send/read AM RX Tone (Bass) level (00=-5 to 10=+5)
		0006	00 to 10 Send/read AM RX Tone (Treble) level (00=-5 to 10=+5)
		0007	see p. 12-4 Send/read FM RX HPF/LPF (HPF: 00=Through, 01=100 to 20=2000, LPF: 5=500 to 24=2400, 25=Through)
		0008	00 to 10 Send/read FM RX Tone (Bass) level (00=-5 to 10=+5)
		0009	00 to 10 Send/read FM RX Tone (Treble) level (00=-5 to 10=+5)
		0010	see p. 12-5 Send/read CW RX HPF/LPF (HPF: 00=Through, 01=100 to 20=2000, LPF: 5=500 to 24=2400, 25=Through)
		0011	see p. 12-5 Send/read RTTY RX HPF/LPF (HPF: 00=Through, 01=100 to 20=2000, LPF: 5=500 to 24=2400, 25=Through)
		0012	see p. 12-5 Send/read PSK RX HPF/LPF (HPF: 00=Through, 01=100 to 20=2000, LPF: 5=500 to 24=2400, 25=Through)
		0013	00 to 10 Send/read SSB TX Tone (Bass) level (00=-5 to 10=+5)
		0014	00 to 10 Send/read SSB TX Tone (Treble) level (00=-5 to 10=+5)
		0015	00 to 10 Send/read AM TX Tone (Bass) level (00=-5 to 10=+5)
		0016	00 to 10 Send/read AM TX Tone (Treble) level (00=-5 to 10=+5)
		0017	00 to 10 Send/read FM TX Tone (Bass) level (00=-5 to 10=+5)
		0018	00 to 10 Send/read FM TX Tone (Treble) level (00=-5 to 10=+5)
		0019	see p. 14-12 Send/read SSB TX bandwidth for wide
		0020	see p. 14-12 Send/read SSB TX bandwidth for mid
		0021	see p. 14-12 Send/read SSB TX bandwidth for narrow
		0022	0000 to 0255 Send/read speech level (0000=0% to 0255=100%)
		0023	0000 to 0255 Send/read CW side tone gain (0000=min. to 0255=max.)
		0024	00/01 Send/read CW side tone gain limit (00=OFF, 01=ON)
		0025	0000 to 0255 Send/read beep gain (0000=min. to 0255=max.)
		0026	00/01 Send/read beep gain limit (00=OFF, 01=ON)
		0027	0000 to 0255 Send/read headphones output ratio (0000=0.60 to 0255=1.40)

Cmd.	Sub Cmd.	Data	Description
1A	05	0028	0000 to 0255 Send/read AF output level to ACC (0000=0% to 0255=100%)
		0029	0000 to 0255 Send/read S/P DIF output level (0000=0% to 0255=100%)
		0030	0000 to 0255 Send/read MOD output level to ACC (0000=0% to 0255=100%)
		0031	0000 to 0255 Send/read S/P DIF MOD output level (0000=0% to 0255=100%)
		0032	00 to 03 Send/read MOD input connector during DATA OFF (00=MIC; 01=ACC; 02=MIC/ACC; 03=S/P DIF; 04=LAN)
		0033	00 to 03 Send/read MOD input connector during DATA1 (00=MIC; 01=ACC; 02=MIC/ACC; 03=S/P DIF; 04=LAN)
		0034	00 to 03 Send/read MOD input connector during DATA2 (00=MIC; 01=ACC; 02=MIC/ACC; 03=S/P DIF; 04=LAN)
		0035	00 to 03 Send/read MOD input connector during DATA3 (00=MIC; 01=ACC; 02=MIC/ACC; 03=S/P DIF; 04=LAN)
		0036	00/01 Send/read relay type selection (00=Reed, 01=MOS-FET)
		0037	00 to 07 Send/read external meter output selection (00=Auto, 01=S, 02=Po, 03=SWR, 04=ALC, 05=COMP, 06=VD, 07=ID)
		0038	0000 to 0255 Send/read external meter output level (0000=0% to 0255=100%)
		0039	00 to 02 Send/read reference signal in/out setting (00=IN, 01=OFF, 02=OUT)
		0040	0000 to 0255 Send/read reference signal frequency setting (0000=0% to 0255=100%)
		0041	0000 to 0255 Send/read LCD unit backlight brightness (0000=0% to 0255=100%)
		0042	0000 to 0255 Send/read switch indicator brightness (0000=1 to 0255=100)
		0043	00 to 01 Send/read screen image type (00=A, 01=B)
		0044	00 to 04 Send/read frequency readout font (00=Basic (1), 01=Basic (2), 02=Italic, 03=Round, 04=Slim)
		0045	00 to 02 Send/read meter response setting (00=SLOW, 01=MID, 02=FAST)
		0046	00 to 02 Send/read meter type (00=Standard, 01=Edgewise, 02=Bar)
		0047	00/01 Send/read meter type during wide screen or mini scope display (00=Edgewise, 01=Bar)
		0048	00/01 Send/read peak hold set for Bar meter (00=OFF, 01=ON)
		0049	00/01 Send/read memory name display setting (00=OFF, 01=ON)
		0050	00/01 Send/read audio peak filter width pop-up display setting (00=OFF, 01=ON)
		0051	00/01 Send/read manual notch width pop-up display setting (00=OFF, 01=ON)
		0052	00 to 03 Send/read screen saver set (0=OFF, 01=15 min., 02=30 min., 03=60 min.)

◇ Command table (continued)

Cmd.	Sub Cmd.	Data	Description	
1A	05	0053	00 to 02 Set/read screen saver type (00=Bound, 01=Rotation, 02=Twist)	
		0054	00/01 Send/read output signal setting for external display (00=OFF, 01=ON)	
		0055	00/01 Send/read synchronous pulse level setting (00=L, 01=H)	
		0056	00/01 Send/read opening message display (00=OFF, 01=ON)	
		0057	see p. 14-11 Send/read opening message contents	
		0058	20000101 to 20991231 Send/read date (20000101=1st Jan. 2000 to 20991231=31st Dec. 2099)	
		0059	0000 to 2359 Send/read time (0000=00:00 to 2359=23:59)	
		0060	00/01 Send/read CLOCK2 function (00=OFF, 01=ON)	
		0061	see p. 14-10 Send/read offset time for CLOCK2 (240001=-24:00 to 240000=+24:00)	
		0062	see p. 14-11 Send/read CLOCK2 name (up to 3-character)	
		0063	00/01 Send/read calibration marker (00=OFF, 01=ON)	
		0064	00/01 Send/read confirmation beep (00=OFF, 01=ON)	
		0065	00	Band edge beep OFF
			01	Band edge beep ON (Beep sounds with a default amateur band)
			02	Band edge beep with user setting ON
			03	Band edge beep with user setting/TX limit ON
		0066	0050 to 0200 Send/read beep audio frequency (0050=500 Hz to 0200=2000 Hz)	
		0067	00/01 Send/read quick split set (00=OFF, 01=ON)	
		0068	see p. 14-11 Send/read FM split offset -9.999 to +9.999 MHz for HF	
		0069	see p. 14-11 Send/read FM split offset -9.999 to +9.999 MHz for 50 MHz	
		0070	00/01 Send/read split lock set (00=OFF, 01=ON)	
		0071	00/01 Send/read tuner auto start set (00=OFF, 01=ON)	
		0072	00/01 Send/read PTT tune set (00=OFF, 01=ON)	
		0073	00/01 Send/read transverter set (00=Auto, 01=ON)	
		0074	see p. 14-11 Send/read transverter offset	
		0075	00 to 02 Send/read RTTY mark frequency (00=1275 Hz, 01=1615 Hz, 02=2125 Hz)	
		0076	00 to 02 Send/read RTTY shift width (00=170 Hz, 01=200 Hz, 02=425 Hz)	
		0077	00/01 Send/read RTTY keying polarity (00=Normal, 01=Reverse)	
		0078	00 to 02 Send/read PSK tone frequency (00=1000 Hz, 01=1500 Hz, 02=2000 Hz)	
		0079	00/01 Send/read speech language (00=English, 01=Japanese)	
		0080	00/01 Send/read speech speed (00=Slow, 01=Fast)	
		0081	00/01 Send/read S-level speech (00=OFF, 01=ON)	
		0082	00/01 Send/read speech with a mode switch operation (00=OFF, 01=ON)	
		0083	00/01 Send/read memo pad numbers (00=5 ch, 01=10 ch)	

Cmd.	Sub Cmd.	Data	Description	
1A	05	0084	00 to 02 Send/read main dial auto TS (00=OFF, 01=Low, 02=High)	
		0085	00/01 Send/read mic. up/down speed (00=Low, 01=High)	
		0086	00/01 Send/read quick RIT/ΔTX clear function (00=OFF, 01=ON)	
		0087	00 to 02 Send/read SSB notch operation (00=Auto, 01=Manual, 02=Auto/Manual)	
		0088	00 to 02 Send/read AM notch operation (00=Auto, 01=Manual, 02=Auto/Manual)	
		0089	00/01 Send/read DIGI-SEL control function (00=DIGI-SEL, 01=APF)	
		0090	00/01 Send/read SSB/CW synchronous tuning function (00=OFF, 01=ON)	
		0091	00/01 Send/read CW normal side set (00=LSB, 01=USB)	
		0092	00/01 Set/read APF type (00=SHARP, 01=SOFT)	
		0093	00/01 Send/read external keypad set for voice memory (00=OFF, 01=ON)	
		0094	00/01 Send/read external keypad set for keyer memory (00=OFF, 01=ON)	
		0095	00/01 Send/read CI-V transceiver set (00=OFF, 01=ON)	
		0096	00/01 Send/read RS-232C function (00=CI-V, 01=Decode)	
		0097	00 to 04	Send/read RS-232C decode Baud rate (00=300, 01=1200, 02=4800, 03=9600, 04=19200)
		0098	00 to 10	Send/read keyboard type (00=English, 01=Japanese, 02=United Kingdom, 03=French, 04=French (Canadian), 05=German, 06=Portuguese, 07=Portuguese (Brazilian), 08=Spanish, 09=Spanish (Latin American), 10=Italian)
		0099	0010 to 0100	Send/read keyboard repeat delay (0010=100 msec., 0100=1000 msec.; 50 msec. steps)
		0100	00 to 31	Send/read keyboard repeat rate (00=2.0 cps to 31=30.0 cps)
		0101	-	Send/read IP address set (0000000000000001=0.0.0.1 to 0255025502550254=255.255.255.254)
		0102	01 to 30	Send/read subnet mask (01=128.0.0.0 to 30=255.255.255.252)
		0103	00/01	Send/read scope display during TX (00=OFF, 01=ON)
		0104	00/01	Send/read scope max. hold (00=OFF, 01=ON)
		0105	00 to 02	Send/read scope center frequency set (00=Filter center, 01=Carrier point center, 02=Carrier point center (Abs. Freq.))
0106	see p. 14-11	Send/read waveform color for receiving signal		
0107	see p. 14-11	Send/read waveform color for max. hold		
0108	00 to 02	Send/read scope sweep speed for ±2.5 kHz span (00=Slow, 01=Mid., 02=Fast)		
0109	00 to 02	Send/read scope sweep speed for ±5 kHz span (00=Slow, 01=Mid., 02=Fast)		
0110	00 to 02	Send/read scope sweep speed for ±10 kHz span (00=Slow, 01=Mid., 02=Fast)		
0111	00 to 02	Send/read scope sweep speed for ±25 kHz span (00=Slow, 01=Mid., 02=Fast)		
0112	00 to 02	Send/read scope sweep speed for ±50 kHz span (00=Slow, 01=Mid., 02=Fast)		

## ◇ Command table (continued)

Cmd.	Sub Cmd.	Data	Description	
1A	05	0113	00 to 02 Send/read scope sweep speed for ±100 kHz span (00=Slow, 01=Mid., 02=Fast)	
		0114	00 to 02 Send/read scope sweep speed for ±250 kHz span (00=Slow, 01=Mid., 02=Fast)	
		0115	see p. 14-11 Send/read scope edge frequencies for 0.03 to 1.60 MHz band	
		0116	see p. 14-11 Send/read scope edge frequencies for 1.60 to 2.00 MHz band	
		0117	see p. 14-11 Send/read scope edge frequencies for 2.00 to 6.00 MHz band	
		0118	see p. 14-11 Send/read scope edge frequencies for 6.00 to 8.00 MHz band	
		0119	see p. 14-11 Send/read scope edge frequencies for 8.00 to 11.00 MHz band	
		0120	see p. 14-11 Send/read scope edge frequencies for 11.00 to 15.00 MHz band	
		0121	see p. 14-11 Send/read scope edge frequencies for 15.00 to 20.00 MHz band	
		0122	see p. 14-11 Send/read scope edge frequencies for 20.00 to 22.00 MHz band	
		0123	see p. 14-11 Send/read scope edge frequencies for 22.00 to 26.00 MHz band	
		0124	see p. 14-11 Send/read scope edge frequencies for 26.00 to 30.00 MHz band	
		0125	see p. 14-11 Send/read scope edge frequencies for 30.00 to 45.00 MHz band	
		0126	see p. 14-11 Send/read scope edge frequencies for 45.00 to 60.00 MHz band	
		0127	00/01 Send/read auto voice monitor set (00=OFF, 01=ON)	
		0128	03 to 10 Send/read voice memory short play time (03=3 sec. to 10=10 sec.)	
		0129	05 to 15 Send/read voice memory normal record time (05= 5 sec. to 30=30 sec.)	
		0130	00	Normal selection for contest number style
			01	"190→ANO" selection for contest number style
			02	"190→ANT" selection for contest number style
			03	"90→NO" selection for contest number style
			04	"90→NT" selection for contest number style
		0131	01 to 04 Send/read count up trigger channel (01=M1, 02=M2, 03=M3, 04=M4)	
		0132	0001 to 9999 Send/read present number (0001=1, 9999=9999)	
		0133	01 to 60 Send/read CW keyer repeat time (01=1 sec. to 60=60 sec.)	
		0134	28 to 45 Send/read CW keyer dot/dash ratio (28=1:1:2.8 to 45=1:1:4.5)	
		0135	00 to 03 Send/read rise time (00=2 msec., 01=4 msec., 02=6 msec., 03=8 msec.)	
		0136	00/01 Send/read paddle polarity (00=Normal, 01=Reverse)	
		0137	00 to 02 Send/read keyer type (00=Straight, 01=Bug-key, 02=ELEC-Key)	
		0138	00/01 Send/read mic. up/down keyer set (00=OFF, 01=ON)	
0139	00 to 03 Send/read FFT scope averaging set for RTTY decoder (00=OFF, 01=2, 02=3, 03=4)			
0140	see p. 14-11 Send/read FFT scope waveform color set for RTTY decoder			
0141	00/01 Send/read RTTY decode USOS (00=OFF, 01=ON)			

Cmd.	Sub Cmd.	Data	Description
1A	05	0142	00/01 Send/read RTTY decode new line code (00=CR,LF,CR+LF, 01=CR+LF)
		0143	00 to 02 Send/read RTTY diddle (00=OFF, 01=Blank, 02=LTRS (Letter code))
		0144	00/01 Send/read RTTY TX USOS (00=OFF, 01=ON)
		0145	00/01 Send/read RTTY auto CR+LF by TX (00=OFF, 01=ON)
		0146	00/01 Send/read RTTY time stamp set (00=OFF, 01=ON)
		0147	00/01 Send/read clock selection for time stamp(0=Local time, 1=CLOCK2)
		0148	00/01 Send/read frequency stamp (00=OFF, 01=ON)
		0149	see p. 14-11 Send/read received text font color
		0150	see p. 14-11 Send/read transmitted text font color
		0151	see p. 14-11 Send/read time stamp text font color
		0152	see p. 14-11 Send/read text font color in TX buffer
		0153	– Send/read FFT scope averaging set for PSK decoder (00=OFF, 01=2, 02=3, 03=4)
		0154	see p. 14-11 Send/read FFT scope waveform color set for PSK decoder
		0155	00/01 Send/read PSK AFC function tuning range (00=±8 Hz, 01=±15 Hz)
		0156	00/01 Send/read PSK time stamp set (00=OFF, 01=ON)
		0157	00/01 Send/read clock selection for time stamp (00=Local time, 01=CLOCK2)
		0158	00/01 Send/read frequency stamp (00=OFF, 01=ON)
		0159	see p. 14-11 Send/read received text font color for PSK decoder
		0160	see p. 14-11 Send/read transmitted text font color (PSK)
		0161	see p. 14-11 Send/read time stamp text font color (PSK)
		0162	see p. 14-11 Send/read text font color in TX buffer (PSK)
		0163	00/01 Send/read scan speed (00=Low, 01=High)
		0164	00/01 Send/read scan resume (00=OFF, 01=ON)
		0165	see p. 14-12 Send/read antenna selection for 0.03 to 1.60 MHz band
		0166	see p. 14-12 Send/read antenna selection for 1.60 to 2.00 MHz band
		0167	see p. 14-12 Send/read antenna selection for 2.00 to 6.00 MHz band
0168	see p. 14-12 Send/read antenna selection for 6.00 to 8.00 MHz band		
0169	see p. 14-12 Send/read antenna selection for 8.00 to 11.00 MHz band		
0170	see p. 14-12 Send/read antenna selection for 11.00 to 15.00 MHz band		
0171	see p. 14-12 Send/read antenna selection for 15.00 to 20.00 MHz band		
0172	see p. 14-12 Send/read antenna selection for 20.00 to 22.00 MHz band		
0173	see p. 14-12 Send/read antenna selection for 22.00 to 26.00 MHz band		
0174	see p. 14-12 Send/read antenna selection for 26.00 to 30.00 MHz band		
0175	see p. 14-12 Send/read antenna selection for 30.00 to 45.00 MHz band		
0176	see p. 14-12 Send/read antenna selection for 45.00 to 60.00 MHz band		

◇ Command table (continued)

Cmd.	Sub Cmd.	Data	Description	
1A	05	0177	00/01 Send/read antenna temporary memory set (00=OFF, 01=ON)	
		0178	00 to 02 Send/read antenna selection (00=OFF, 01=Manual, 02=Auto)	
		0179	00/01 Send/read usage for ANT2 (00=OFF, 01=TX/RX)	
		0180	00/01 Send/read usage for ANT3 (00=OFF, 01=TX/RX)	
		0181	00 to 02 Send/read usage for ANT4 (00=OFF, 01=TX/RX, 02= RX)	
		0182	00 to 20 Send/read VOX delay (00=0.0 sec. to 20=2.0 sec.)	
		0183	00 to 03 Send/read VOX voice delay (00=OFF, 01=Short, 02=Mid., 03=Long)	
		0184	00 to 09 Send/read NB depth (00=1 to 09=10)	
		0185	0000 to 0255 Send/read NB width (0000=0 to 0255=255)	
		0186	00/01 Send/read external keypad set for RTTY memory (00=OFF, 01=ON)	
		0187	00/01 Send/read external keypad set for PSK memory (00=OFF, 01=ON)	
		0188	00/01 Voice memory transmission set for [F1]– [F4] on the keyboard (00=OFF, 01=ON)	
		0189	00/01 Memory keyer transmission set for [F1]– [F4] on the keyboard (00=OFF, 01=ON)	
		0190	00	Send/read time-out timer OFF
			01	Send/read 3 min. time-out timer
			02	Send/read 5 min. time-out timer
			03	Send/read 10 min. time-out timer
			04	Send/read 20 min. time-out timer
			05	Send/read 30 min. time-out timer
		0191	00 to 06 Send/read APF AF level. (00=0 dB to 06=+6dB)	
		0192	0000 to 0255 Send/read LAN MOD output level (0000=0% to 0255=100%)	
		0193	00 to 05 Send/read the TX Delay setting (HF) (00=OFF, 01=10 ms, 02=15 ms, 03=20 ms, 04=25 ms, 05=30 ms)	
		0194	00 to 05 Send/read the TX Delay setting (50M) (00=OFF, 01=10 ms, 02=15 ms, 03=20 ms, 04=25 ms, 05=30 ms)	
		0195	00, 01 Send/read the Shutdown function. (00=Shutdown, 01=Standby/Shut-down)	
		0196	0000 to 0223 Send/read the transceive CI-V Address for LAN to REMOTE in hexadecimal code. (0000=00h to 0223=DFh)	
		0197	Send/read the default gateway set (0000000000000001=0.0.0.1 to 0255 025502550254=255.255.255.254, or FF=Blank)	
		0198	00, 01 Send/read the remote control capability. (00=OFF, 01=ON)	
		0199	000001 to 065535 Send/read the control port setting by accessing from internet. (000001=1 to 065535=65535)	
		0200	000001 to 065535 Send/read the serial port setting by accessing from internet. (000001=1 to 065535=65535)	
		0201	000001 to 065535 Send/read the audio port setting by accessing from internet. (000001=1 to 065535=65535)	

Cmd.	Sub Cmd.	Data	Description
1A	05	0202	00, 01 Send/read the internet access line setting. (00=FTTH (Fiber To The Home), 01=ADSL/CATV)
		0203	see p. 14-14 Send/read Network radio name (up to 16-character)
		0204	00 to 04 Send/read the maximum AF sample rates for remote stations. (00=8 kHz, 01=12 kHz, 02=16 kHz, 03=24 kHz, 04=48 kHz)
		0205	00 to 02 Send/read the AF codecs for remote stations. (00=LPCM 8bit, 01=LPCM 8bit, u-law 8bit, 02=LPCM 8bit, u-law 8bit, LPCM 16bit)
		0206	00, 01 Send/read the network TX audio setting for remote stations. (00=OFF, 01=ON)
		0207	00 to 04 Send/read the maximum modulation sample rates for remote stations. (00=8 kHz, 01=12 kHz, 02=16 kHz, 03=24 kHz, 04=48 kHz)
		0208	00 to 02 Send/read the modulation codecs for remote stations. (00=LPCM 8bit, 01=LPCM 8bit, u-law 8bit, 02=LPCM 8bit, u-law 8bit, LPCM 16bit)
		0209	00, 01 Send/read the waveform outline indication on the spectrum scope. (00=Fill, 01=Fill+Line)
		0210	see p. 14-11 Send/read the waveform outline color for receiving signal.
		0211	00, 01 Send/read the waterfall display on the Spectrum scope. (00=OFF, 01=ON)
		0212	00 to 07 Send/read the peak color level for displaying the waterfall. 00=Grid 1, 01=Grid 2, 02=Grid 3, 03=Grid 4, 04=Grid 5, 05=Grid 6, 06=Grid 7, 07=Grid 8
		0213	00, 01 Send/read waveform type on the Audio FFT scope. (00=Fill, 01=Line)
		0214	see p. 14-11 Send/read waveform color for Audio FFT scope.
		0215	00, 01 Send/read the waterfall display on the Audio FFT scope. (00=OFF, 01=ON)
		0216	see p. 14-11 Send/read waveform color for Audio Oscilloscope scope.
		0217	00, 01 Send/read the voice 1st menu. (00=VOICE-Root, 01=VOICE-PLAY)
		0218	01 to 15 Send/read the repeat interval to transmit the recorded voice audio. (01=1 sec. to 15=15 sec.)
		0219	00, 01 Send/read the recording mode. (00=TX&RX, 01=RX Only)
		0220	00, 01 Send/read the squelch status for the RX voice audio recording (00=Always, 01=Squelch Auto)
		0221	00, 01 Send/read the QSO audio record file Split function setting. (00=OFF, 01=ON)
		0222	00, 01 Send/read the PTT Automatic Recording function setting. (00=OFF, 01=ON)
		0223	00 to 03 Send/read QSO PLAY Skip time. (00=3 sec., 01=5 sec., 02=10 sec., 03=30 sec.)



## ◇ Command table (continued)

Cmd.	Sub Cmd.	Data	Description	
1A	05	0224	00, 01	Send/read antenna controller status (frequency, and so on) data output from [REMOTE] (00=OFF, 01=ON)
	06	see p. 14-11		Send/read DATA mode with filter set
	07	00		WIDE selection for SSB transmit bandwidth
		01		MID selection for SSB transmit bandwidth
		02		NAR selection for SSB transmit bandwidth
	08	00		SHARP selection for DSP filter type
		01		SOFT selection for DSP filter type
	09	00		3 kHz roofing filter selection
		01		6 kHz roofing filter selection
		02		15 kHz roofing filter selection
	0A	00		WIDE selection for manual notch width
		01		MID selection for manual notch width
		02		NAR selection for manual notch width
1B	00	see p. 14-11	Send/read repeater tone frequency	
	01	see p. 14-11	Send/read TSQL tone frequency	
1C	00	00	Send/read transceiver's status (RX) When "CI-V Output (for ANT)" (Command: 1C 04) is set to "ON," automatically outputs when changed.	
		01	Send/read transceiver's status (TX) When "CI-V Output (for ANT)" (Command: 1C 04) is set to "ON," automatically outputs when changed.	
	01	00	Antenna tuner OFF (through)	
		01	Antenna tuner ON	
		02	Tuning	
	02	00, 01	Send/read transmit frequency monitor setting (00=OFF, 01=ON)	
	03	see p. 14-10	Read transmit frequency When "CI-V Output (for ANT)" (Command: 1C 04) is set to "ON," automatically outputs when changed.	
	04	00	Send/read command to disable to output the antenna controller status (frequency and so on) from [REMOTE].	
01		Send/read command to enable to output the antenna controller status (frequency and so on) from [REMOTE].		
1E	00	–	Read number of available TX frequency band	
	01	see p. 14-12	Read TX band edge frequencies	
	02	–	Read number of user-set TX frequency band	
	03	see p. 14-12	Send/read user-set TX band edge frequencies	
21	00	see p. 14-12	Send/read RIT frequency.	
	01	00, 01	Send/read RIT setting. (00=OFF, 01=ON)	
	02	00, 01	Send/read ΔTX setting. (00=OFF, 01=ON)	
25		see p. 14-14	Send/read the selected or unselected VFO frequency.	
26		see p. 14-14	Send/read the selected or unselected VFO's operating mode and filter.	

## ◇ Data contents description

### • Operating frequency

Command : 00, 03, 05, 1C 03

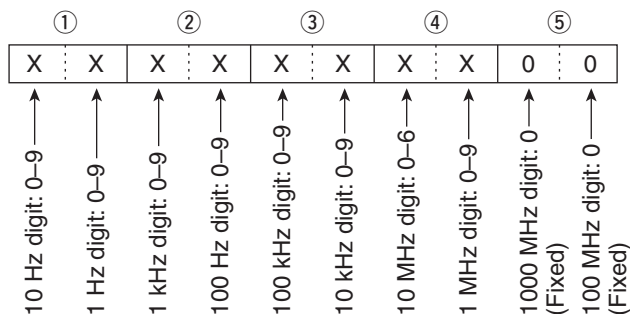

### • Operating mode

Command : 01, 04, 06

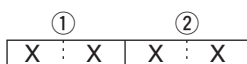

① Operating mode		② Filter setting
00: LSB	05: FM	01: FIL1
01: USB	07: CW-R	02: FIL2
02: AM	08: RTTY-R	03: FIL3
03: CW	12: PSK	
04: RTTY	13: PSK-R	

Filter setting (②) can be skipped with command 01 and 06. In that case, "FIL1" is selected with command 01 and the default filter setting of the operating mode is selected with command 06, automatically.

### • Memory keyer contents

Command : 1A 02

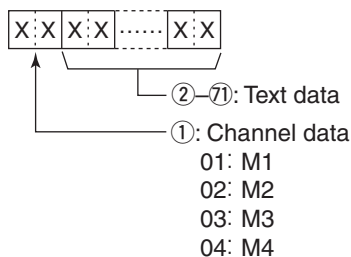

### • Character's code

Character	ASCII code	Description
0-9	30-39	Numerals
A-Z	41-5A	Alphabetical characters
space	20	Word space
/	2F	Symbol
?	3F	Symbol
,	2C	Symbol
.	2E	Symbol
@	40	Symbol
^	5E	Example: To send BT̄, enter ^BT (5E4254)
*	2A	Inserts contest number (can be used for 1 channel only)

### • Band stacking register

Command : 1A 01

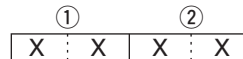

#### ① Frequency band code

Code	Freq. band	Frequency range (unit: MHz)
01	1.8	1.800000- 1.999999
02	3.5	3.400000- 4.099999
03	7	6.900000- 7.499999
04	10	9.900000- 10.499999
05	14	13.900000- 14.499999
06	18	17.900000- 18.499999
07	21	20.900000- 21.499999
08	24	24.400000- 25.099999
09	28	28.000000- 29.999999
10	50	50.000000- 54.000000
11	GENE	Other than above

#### ② Register code

Code	Registered No.
01	1 (latest)
02	2
03	3 (oldest)

For example, when reading the oldest contents in the 21 MHz band, the code "0703" is used.

When sending the contents, the following code should be added after code ②.

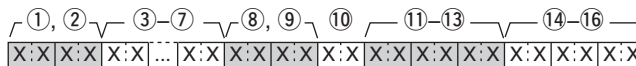

#### ③-⑦ Operating frequency setting

See "• Operating frequency."

#### ⑧, ⑨ Operating mode setting

See "• Operating mode."

#### ⑩ Data mode setting

1 byte data (XX)

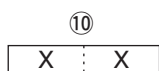

0: OFF, 1: DATA 1, 2: DATA 2, 3: DATA 3

#### ⑪-⑬ Repeater tone frequency setting

#### ⑭-⑯ Tone squelch frequency setting

See "• Repeater tone/tone squelch setting."

### • Clock 2 offset time setting

Command : 1A 05 0061

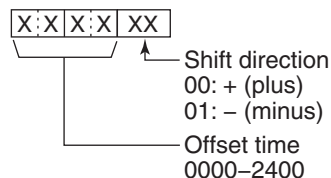

**• Offset frequency setting**

Command : 1A 05 0068, 0069, 0074

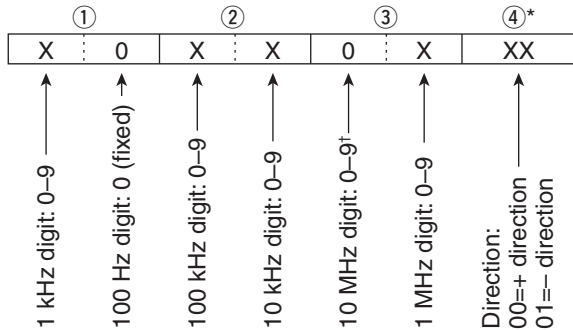

\*No need to enter for transverter offset frequency setting.  
†Transverter offset only; Fix to '0' for split offset setting.

**• Codes for memory name, opening message and CLOCK2 name contents**

- Character's code— Alphabetical characters

Character	ASCII code	Character	ASCII code
A-Z	41-5A	a-z	61-7A

- Character's code— Symbols

Character	ASCII code	Character	ASCII code
!	21	#	23
\$	24	%	25
&	26	\	5C
?	3F	"	22
'	27	`	60
^	5E	+	2B
-	2D	*	2A
/	2F	.	2E
,	2C	:	3A
;	3B	=	3D
<	3C	>	3E
(	28	)	29
[	5B	]	5D
{	7B	}	7D
	7C	_	5F
-	7E	@	40

Command	Set item/available characters
1A 00	Memory name All characters are available.
1A 050058	Opening message Capital letters, numerals, some symbols (- / . @) and space are available.
1A 050063	CLOCK2 name Capital letters, small letters, numerals, some symbols (! # \$ % & \ ? " ' ` ^ + - * / . , ; = < > ( ) [ ] { }   _ ' @) and space are available.

**• Color setting**

Command : 1A 05 0106, 0107, 0140, 0149, 0150, 0151, 0152, 0154, 0159, 0160, 0161, 0162, 0210, 0214, 0216

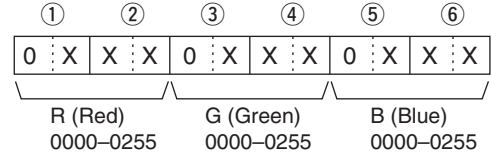

**• Bandscope edge frequency setting**

Command : 1A 05 0115, 0116, 0117, 0118, 0119, 0120, 0121, 0122, 0123, 0124, 0125, 0126

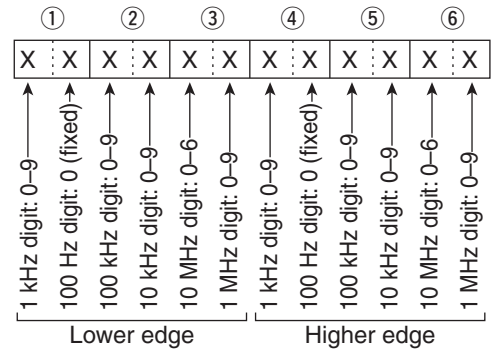

**• Data mode with filter width setting**

Command : 1A 06

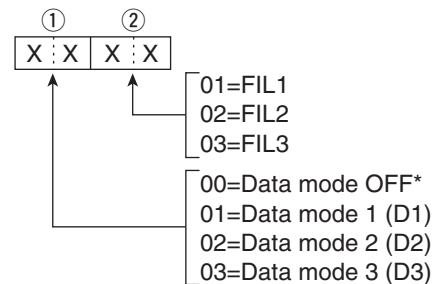

\* When "00" is set, set "00" in ②.

**• Repeater tone/tone squelch frequency setting**

Command : 1B 00, 1B 01

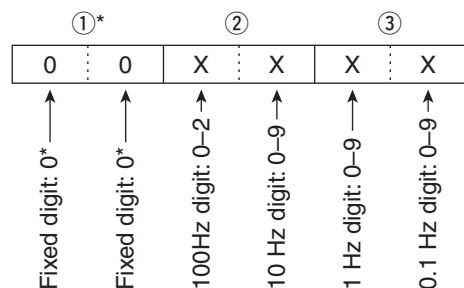

\*Not necessary when setting a frequency.

## ◇ Data contents description (continued)

### • SSB transmission passband width setting

The following data sequence is used when sending or reading the SSB transmission passband width setting.

Command : 1A 05 0019, 0020, 0021

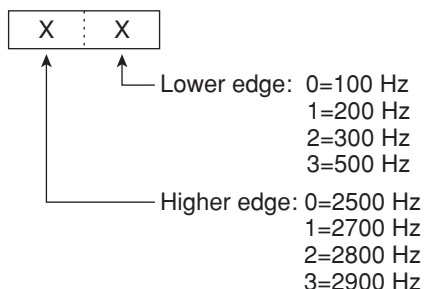

### • Antenna memory setting

The following codes are used when sending or reading the antenna memory setting.

Command : 1A 05 0165–0176

Data	Antenna selection	
	for TX	for RX
00	ANT1	
01	ANT2	
02	ANT3	
03	ANT4	
04*	ANT1	ANT4
05*	ANT2	ANT4
06*	ANT3	ANT4

\*\*"RX" should be selected for ANT4.

### • RIT frequency setting

Command : 21 00

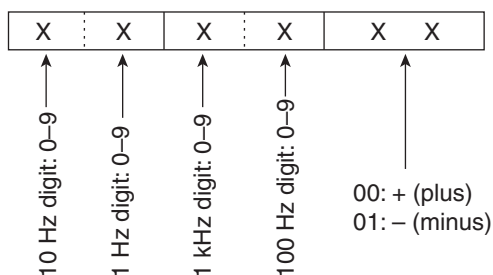

### • Band edge frequency setting

Command 02\*, 1E 01, 1E 03

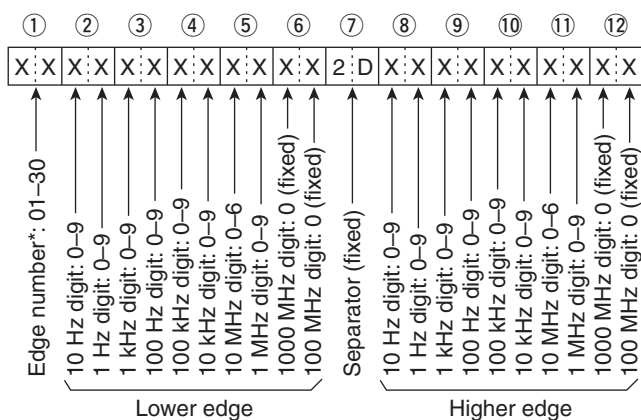

\* Edge number setting is not necessary with command 02.

### • Codes for CW message contents

To send CW messages, the following character codes are used.

Character	ASCII code	Character	ASCII code
0-9	30-39	'	27
A-Z	41-5A	(	28
a-z	61-7A	)	29
/	2F	=	3D
?	3F	+	2B
.	2E	"	22
-	2D	@	40
,	2C	Space	20
:	3A		

Command : 17 Up to 30 characters

- "FF" stops sending CW messages.
- "^" is used to transmit a string of characters with no inter-character space.

◇ Data contents description (continued)

• Memory content setting

Command : 1A 00

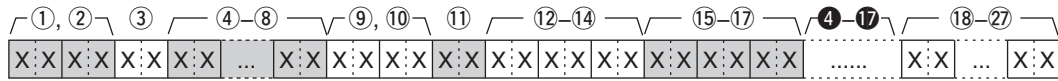

④-⑰: Are programmed in the same manner as ④-⑰.  
 When the split setting is ON, these settings are the matching transmit settings.  
 Even when the split setting is OFF, these settings are still necessary.  
 Be sure the settings are compatible with the specifications of the IC-7700.

①, ② Memory channel number

0001-0099 : Memory channel 1 to 99

0100 : Programmed scan edge P1

0101 : Programmed scan edge P2

▨ To clear the memory channel contents, add the code "FF" after the memory channel number. (instead of the data ③ to ⑰).

▨ This completes the memory clearing.

③ Split setting, Select memory setting

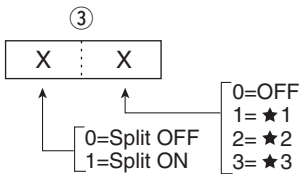

When setting the programmed scan edges P1 or P2, you must select OFF for both settings.

④-⑧ Operating frequency setting

See "• Operating frequency."

⑨, ⑩ Operating mode setting

See "• Operating mode."

⑪ Data mode and tone type settings

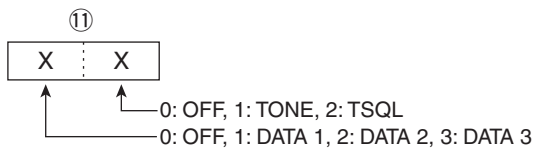

⑫-⑭ Repeater tone frequency setting

⑮-⑰ Tone squelch frequency setting

See "• Repeater tone/tone squelch setting."

⑱-⑳ Memory name setting

Up to 10 characters.

See "• Codes for memory name, opening message and Clock 2 name contents."

# 14 CONTROL COMMAND

## ◇ Data contents description (continued)

### • Codes for Network Radio name contents

Command : 1A 05 0203

- Character's code— Number

Character	ASCII code	Character	ASCII code
0-9	30-39		

- Character's code— Alphabetical characters

Character	ASCII code	Character	ASCII code
A-Z	41-5A	a-z	61-7A

- Character's code— Symbols

Character	ASCII code	Character	ASCII code
!	21	#	23
\$	24	%	25
&	26	?	3F
”	22	,	27
`	60	^	5E
+	2B	-	2D
*	2A	/	2F
.	2E	,	2C
:	3A	;	3B
=	3D	<	3C
>	3E	(	28
)	29	[	5B
]	5D	{	7B
}	7D		7C
_	5F	-	7E
@	40		

### • Selected or unselected VFO's frequency settings

Command : 25

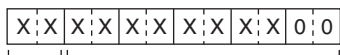

00: MAIN    Operating frequency data  
01: SUB    (See p. 14-10)

### • Selected or unselected VFO's operating mode and filter settings

Command : 26

Both data and filter settings can be skipped. In that case, "DATA OFF" and the default filter setting of the operating mode is automatically selected.

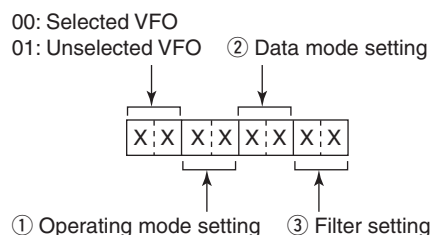

① Operating mode		② Data mode setting		③ Filter setting	
00: LSB	05: FM	00: Data mode OFF	01: FIL1		
01: USB	07: CW-R	01: Data mode 1 (D1)	02: FIL2		
02: AM	08: RTTY-R	02: Data mode 2 (D2)	03: FIL3		
03: CW	12: PSK	03: Data mode 3 (D3)			
04: RTTY	13: PSK-R				

---

■ Specifications .....	15-2
◇ General .....	15-2
◇ Transmitter .....	15-2
◇ Receiver .....	15-3
◇ Antenna tuner .....	15-3
■ Options .....	15-4

## ■ Specifications

### ◇ General

- **Frequency coverage** (unit: MHz) :
  - Receiver : 0.030000–60.000000\*<sup>1</sup>
  - Transmitter : 1.800000–1.999999\*<sup>2</sup>, 3.500000–3.999999\*<sup>2</sup>,  
5.255000 – 5.405000\*<sup>1</sup>, 7.000000–7.300000\*<sup>2</sup>,  
10.100000–10.150000\*<sup>2</sup>, 14.000000–14.350000\*<sup>2</sup>,  
18.068000–18.168000\*<sup>2</sup>, 21.000000–21.450000\*<sup>2</sup>,  
24.890000–24.990000\*<sup>2</sup>, 28.000000–29.700000\*<sup>2</sup>,  
50.000000–54.000000\*<sup>2</sup>
- **Operating mode** : J3E (USB/LSB), A1A (CW), F1B (RTTY),  
G1B (PSK31), A3E (AM), F3E (FM)
- **Number of memory channels** : 101 (99 regular, 2 scan edges)
- **Antenna connector** : SO-239×4 (antenna impedance: 50 Ω)
- **Operating temperature range** : 0°C to +50°C; +32°F to +122°F
- **Frequency stability** : Less than ±0.05 ppm (approximately 5 minutes after  
from turn the main power, [I/O], ON, 0–50°C; 32–122°F)
- **Frequency resolution** : 1 Hz
- **Power supply requirement** : 85–265 V AC (universal input)
- **Power consumption** :
  - Receive : 200 VA typical
  - Stand-by : 210 VA typical
  - Max. audio : 800 VA
  - Transmit at 200 W
- **Dimensions** (projections not included) : 425×149×437 mm; 16.7×5.9×17.2 in
- **Weight** : Approximately 22.5 kg; 50 lb
- **ACC 1 connector** : 8-pin DIN connector
- **ACC 2 connector** : 7-pin DIN connector
- **Display\*** : 7-inch (diagonal) TFT color LCD (800×480)
- **EXT-DISPLAY connector** : D-sub 15S
- **CI-V connector** : 2-conductor 3.5 (d) mm (1/8")
- **RS-232C connector** : D-sub 9-pin
- **USB connector** : USB (Universal Serial Bus)1.1/2.0×2

\*<sup>1</sup> Some frequency ranges are not guaranteed.

\*<sup>2</sup> Depending on versions.

### ◇ Transmitter

- **Transmit output power** :
  - SSB, CW, RTTY, PSK31, FM : 5–200 W
  - AM : 5–50 W
- **Modulation system** :
  - SSB : D.P.S.N. modulation
  - AM : Digital low power modulation
  - FM : Digital phase modulation
- **Spurious emission** :
  - Harmonics : More than 60 dB (HF bands)  
More than 70 dB (50 MHz band)
  - Unwanted emission : More than 50 dB (HF bands)
  - (except Harmonics) : More than 66 dB (50 MHz band)
  - Out of band emission : More than 40 dB (HF bands)  
More than 60 dB (50 MHz band)
- **Carrier suppression** : More than 63 dB
- **Unwanted side-band suppression** : More than 80 dB
- **ΔTX variable range** : ±9.999 kHz
- **Microphone connector** : 8-pin connector (600 Ω)
- **ELEC-KEY connector** : 3-conductor 6.35 (d) mm (1/4")
- **KEY connector** : 3-conductor 6.35 (d) mm (1/4")
- **RELAY connector** : Phono (RCA)
- **ALC connector** : Phono (RCA)



## ◇ Receiver

- **Receive system** : Double conversion superheterodyne system
- **Intermediate frequencies** :
  - 1st 64.455 MHz
  - 2nd 36 kHz
- **Sensitivity (typical)** :
  - SSB, CW, RTTY (BW=2.4 kHz, 10 dB S/N)
    - 0.100000– 1.799999 MHz 0.5  $\mu$ V (Preamp 1 ON)
    - 1.800000–29.990000 MHz 0.16  $\mu$ V (Preamp 1 ON)
    - 50.000000–54.000000 MHz 0.13  $\mu$ V (Preamp 2 ON)
  - AM (BW=6 kHz, 10 dB S/N)
    - 0.100000– 1.799999 MHz 6.3  $\mu$ V (Preamp 1 ON)
    - 1.800000–29.990000 MHz 2  $\mu$ V (Preamp 1 ON)
    - 50.000000–54.000000 MHz 1  $\mu$ V (Preamp 2 ON)
  - FM (BW=15 kHz, 12 dB SINAD)
    - 28.000000–29.990000 MHz 0.5  $\mu$ V (Preamp 1 ON)
    - 50.000000–54.000000 MHz 0.32  $\mu$ V (Preamp 2 ON)
- **Internal Modulate Distortion (typical)** : Dynamic range 109 dB (at 14.100 MHz, 100 kHz separation, Preamp OFF, CW mode; BW=500 Hz)
- **Selectivity** :
  - SSB, RTTY (BW=2.4 kHz)
    - More than 2.4 kHz/–3 dB
    - Less than 3.6 kHz/–60 dB
  - CW (BW=500 Hz)
    - More than 500 Hz/–3 dB
    - Less than 700 Hz/–60 dB
  - AM (BW=6 kHz)
    - More than 6.0 kHz/–3 dB
    - Less than 15.0 kHz/–60 dB
  - FM (BW=15 kHz)
    - More than 12.0 kHz/–6 dB
    - Less than 20.0 kHz/–60 dB
- **Spurious and image rejection ratio** : More than 70 dB
- **Squelch sensitivity (Preamp OFF)** :
  - SSB, CW, RTTY, PSK31 Less than 5.6  $\mu$ V
  - FM Less than 1  $\mu$ V
- **RIT variable range** :  $\pm$ 9.999 kHz
- **Audio output power** : More than 2.6 W at 10% distortion with an 8  $\Omega$  load
- **PHONES connector** : 3-conductor 6.35 (d) mm (1/4")
- **EXT-SP connectors** : 2-conductor 3.5 (d) mm (1/8")/8  $\Omega$

## ◇ Antenna tuner

- **Matching impedance range** : 16.7 to 150  $\Omega$  unbalanced (HF bands; VSWR better than 3:1)  
20 to 125  $\Omega$  unbalanced (50 MHz band; VSWR better than 2.5:1)
- **Minimum operating input** : 8 W (HF bands)  
15 W (50 MHz band)
- **Tuning accuracy** : VSWR 1.5:1 or less
- **Insertion loss (after tuning)** : Less than 1.0 dB

\*The LCD display may have cosmetic imperfections that appear as small or dark spots. This is not a malfunction or defect, but a normal characteristic of LCD displays.

Spurious signals may be received near the following frequencies. These are made in the internal circuit and does not indicate a transceiver malfunction.

- 0.15 MHz      • 0.23 MHz      0.31 MHz      • 10 MHz

Spurious signals may be displayed on the spectrum scope screen regardless of the transceiver's state (Tx or Rx). They are generated in the scope circuit. This does not indicate a transceiver malfunction.

**All stated specifications are typical and subject to change without notice or obligation.**

## Options

• **IC-PW1/EURO**

HF/50 MHz ALL BAND 1 kW LINEAR AMPLIFIER



Full-duty-cycle 1 kW linear amplifier including an automatic antenna tuner. Has automatic tuning and band selection capability when used with an Icom transceiver. Full break-in (QSK) operation. The amplifier/power supply unit and the remote control unit can be separately installed.

• **SP-34** EXTERNAL SPEAKER



4 audio filters; headphone jack; can connect to 2 transceivers.

- Input impedance : 8 Ω
- Max. input power : 5 W

• **SM-50** DESKTOP MICROPHONE



Unidirectional, dynamic microphone for base station operation. Includes [UP]/[DOWN] switches, a low cut switch and mic gain control.

• **SM-30** DESKTOP MICROPHONE



Unidirectional, electret microphone for base station operation. Includes low cut switch and mic gain control.

• **HM-36** HAND MICROPHONE



Hand microphone equipped with [UP]/[DOWN] switches.

• **CT-17** CI-V LEVEL CONVERTER



This unit converts signal levels from RS-232C data to the serial CI-V data. This can be used for remote transceiver control using PC. You can change frequencies, operating mode, memory channels, etc. (software is not included)

• **SP-33** EXTERNAL SPEAKER

Designed for base station operation.

- Input impedance : 8 Ω
- Max. input power : 5 W

• **RS-BA1** IP REMOTE CONTROL SOFTWARE

☞ To remotely control radios using the RS-BA1, **BE SURE** that you comply with your local regulations.

Approved Icom optional equipment is designed for optimal performance when used with an Icom transceiver. Icom is not responsible for the destruction or damage to an Icom transceiver in the event the Icom transceiver is used with equipment that is not manufactured or approved by Icom.

- General ..... 16-2
- Caution ..... 16-2
- Preparation ..... 16-3
  - ◇ Firmware and firm utility ..... 16-3
  - ◇ File downloading ..... 16-3
- Firmware update— USB flash drive ..... 16-4
- Firmware update— PC ..... 16-6
  - ◇ Connections ..... 16-6
  - ◇ IP address setting ..... 16-7
  - ◇ Updating from a PC ..... 16-8

## ■ General

At least one available USB (2.0 or 1.1) port is required to copy the downloaded firmware file. An Ethernet card/board (10 BASE-T/100 BASE TX compatible) is required when updating the firmware from the PC. The USB hub and Ethernet card/board are not supplied by Icom. Ask your PC dealer about a USB hub and an Ethernet card/board for details.

The IC-7700's firmware can be updated if desired. By updating the firmware, new function(s) can be added and the improvement of performance parameters can be obtained.

2 methods of firmware update are available: one uses the USB flash drive, and the other uses a PC. You can choose either methods according to your PC capabilities.

- When only one PC connected to the Internet is available
  - ➔ Refer to ■ Preparation (p. 16-3) and ■ Firmware update— USB flash drive (p. 16-4)
- When two or more PCs connected to the Internet are available and they are connected to a LAN (Local Area Network)
  - ➔ Refer to ■ Preparation (p. 16-3) and either ■ Firmware update— PC (p. 16-6) or ■ Firmware update— USB flash drive (p. 16-4)

Ask your dealer or distributor about how to update the firmware if you have no PC.

## ◇ Firmware confirmation



← Firmware version

The firmware version of the IC-7700 can be confirmed during turning power ON.

- The firmware version appears at the right bottom corner.

## ■ Caution

**CAUTION: NEVER** turn the transceiver power OFF while updating the firmware.

You can turn the transceiver power OFF only when the transceiver displays that rebooting is required.

If you turn the transceiver power OFF, or if a power failure occurs during updating, the transceiver firmware will be corrupted and you will have to send the transceiver back to the nearest Icom distributor for repair. This type of repair is out of warranty even if the warranty period is still valid.

---

### ***Recommendation!***

Backing up the settings and/or memory contents to the USB flash drive before starting the firmware update is recommended.

Settings and/or memory contents will be lost or returned to default settings when the firmware update is performed.

---

## ■ Preparation

### ◇ Firmware and firm utility

The latest firmware and the firm utility can be downloaded from the Icom home page via the Internet. Access the following URL to download the firm utility and the latest firmware.

<http://www.icom.co.jp/world/index.html>

### **For updating from the USB flash drive**

When updating the firmware from the USB flash drive, copy the downloaded firmware data (example: 7700\_200.dat) to the USB flash drive (in "IC-7700" folder) using an available USB port (USB hub may be required; purchased separately from your PC dealer).

### ◇ File downloading

- ① Access the following URL.  
<http://www.icom.co.jp/world/index.html>
- ② Click [Support] button.
- ③ Click "Firmware Updates/Software Downloads" link then click the firmware file link.
- ④ Click the desired firmware file link in IC-7700 group.

- ⑤ Read "Regarding this Download Service" carefully, then click [AGREE].

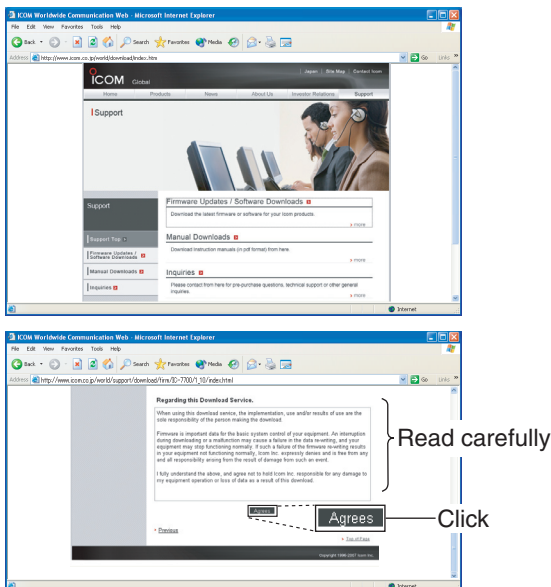

- ⑥ Click [Save] in the displayed File Download dialog.

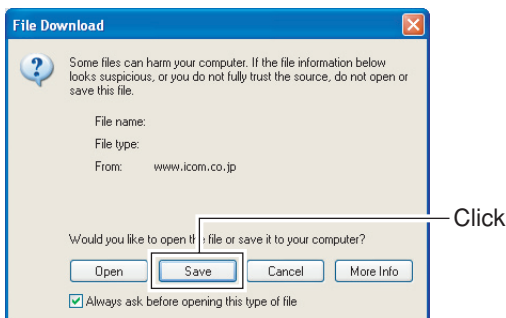

- ⑦ Select the desired location in which you want to save the firmware, then click [Save] in the displayed File Download dialog.
  - File download starts.

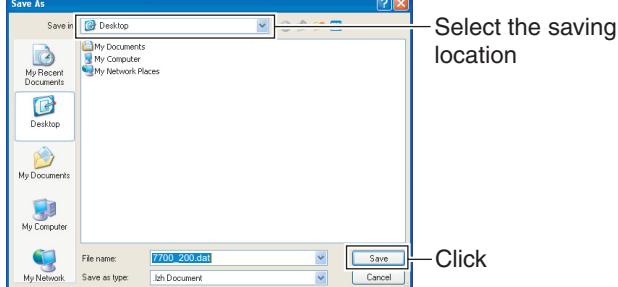

- ⑧ After download is completed, extract the file.
  - The firmware and the firm utility are compressed in "zip" format, respectively.
  - When updating the transceiver using with the USB flash drive, copy the extracted firmware (example: 7700\_200.dat) to the USB flash drive's IC-7700 folder.
  - The USB flash drive must have been formatted by the IC-7700. (p. 12-30)

## Firmware update— USB flash drive

When updating the firmware with the USB flash drive, no IP address or subnet mask settings are necessary.

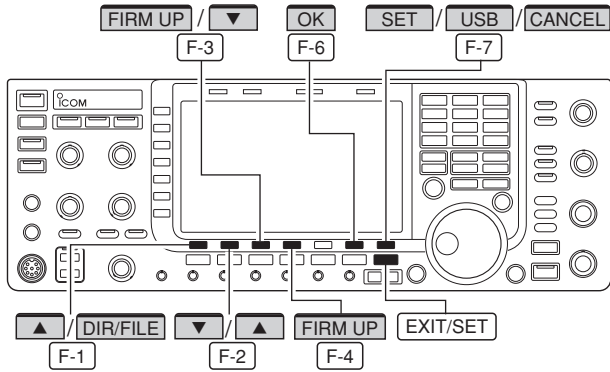

- ① Copy the downloaded firmware data into the USB flash drive (“IC-7700” folder).
  - The USB flash drive must have been formatted by the IC-7700.
- ② Insert the USB flash drive into the USB connector.
- ③ Push [EXIT/SET] several times to close a multi-function screen, if necessary.
- ④ Push [SET] [F-7] to select set mode menu screen.
- ⑤ Push [USB] [F-7] to select USB-Memory set menu.

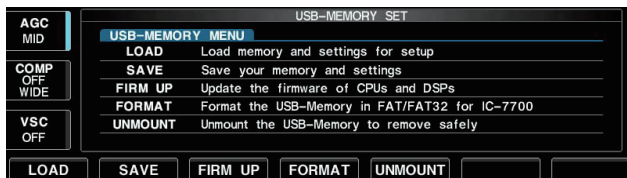

- ⑥ Hold down [FIRM UP] [F-3] for 1 second.

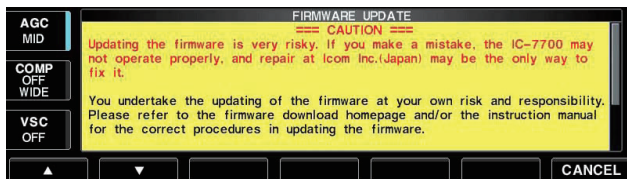

- ⑦ Read the displayed precaution carefully.
  - Push [▲] [F-1] or [▼] [F-2] to scroll the display.
  - Push [CANCEL] [F-7] to cancel the firmware updating.

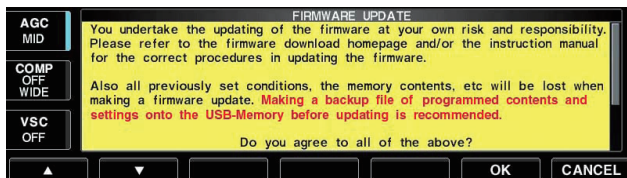

- ⑧ After you read and understand all of the precautions, push [OK] [F-6].
  - [OK] [F-6] appears only following the precautions.
  - Push [CANCEL] [F-7] to cancel the firmware updating.

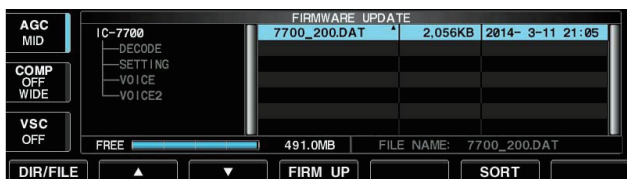

- ⑨ Push [▲] [F-2] or [▼] [F-3] to select the firmware file, then push [FIRM UP] [F-4].



- ⑩ Read the displayed precautions carefully.
- ⑪ If you agree, hold down [OK] [F-6] for 1 second to start the firmware update.
  - Push [CANCEL] [F-7] to cancel the firmware updating.

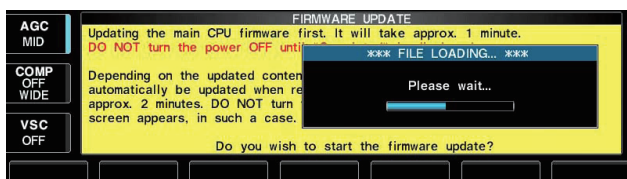

- ⑫ While loading the firmware from the USB flash drive, the dialog as at left is displayed.

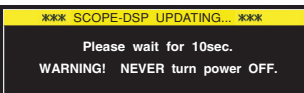
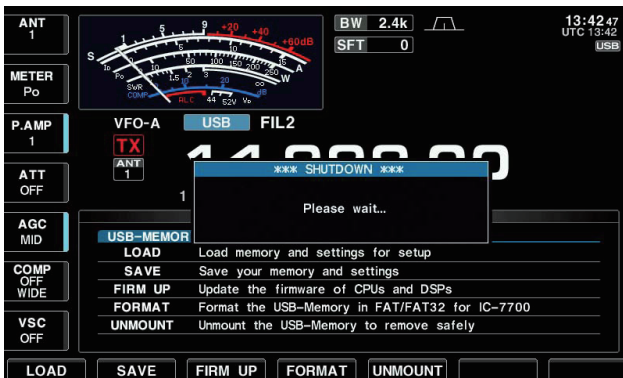
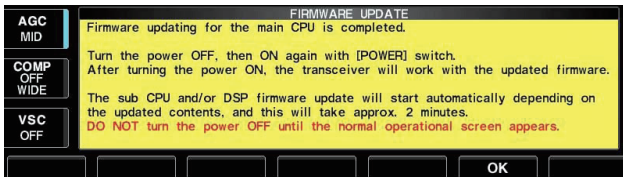
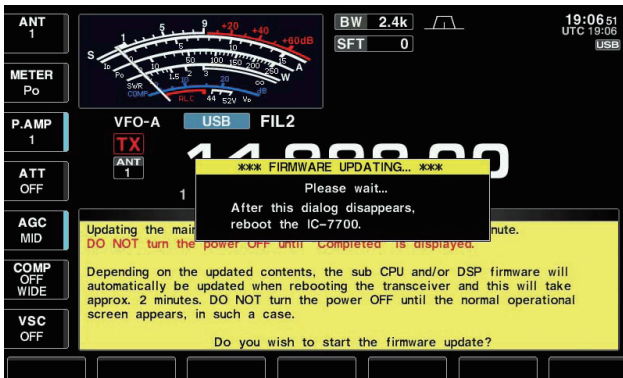

⑬ After the firmware loading is completed, the transceiver starts the update automatically and the dialog at left is displayed.

⚠ **WARNING! NEVER** turn the IC-7700 power OFF at this stage.  
 The transceiver firmware will be corrupted.

⑭ When the dialog disappears, the precaution at left is displayed.

⑮ Read the precaution carefully, and then push [OK] [F-6].  
 • Return to USB-Memory set menu.

⑯ Push [POWER] to turn the IC-7700 power OFF, then ON again.

⑰ Depending on the update, one or two dialog boxes as at left appear in sequence.

⚠ **WARNING! NEVER** turn the IC-7700 power OFF at this stage.  
 The transceiver firmware will be corrupted.

⑱ After the dialog disappears, the firmware updating is completed and normal operation screen appears.

## ■ Firmware update — PC

### ◇ Connections

Connect the IC-7700 and the PC through a LAN (Local Area Network) as follows.

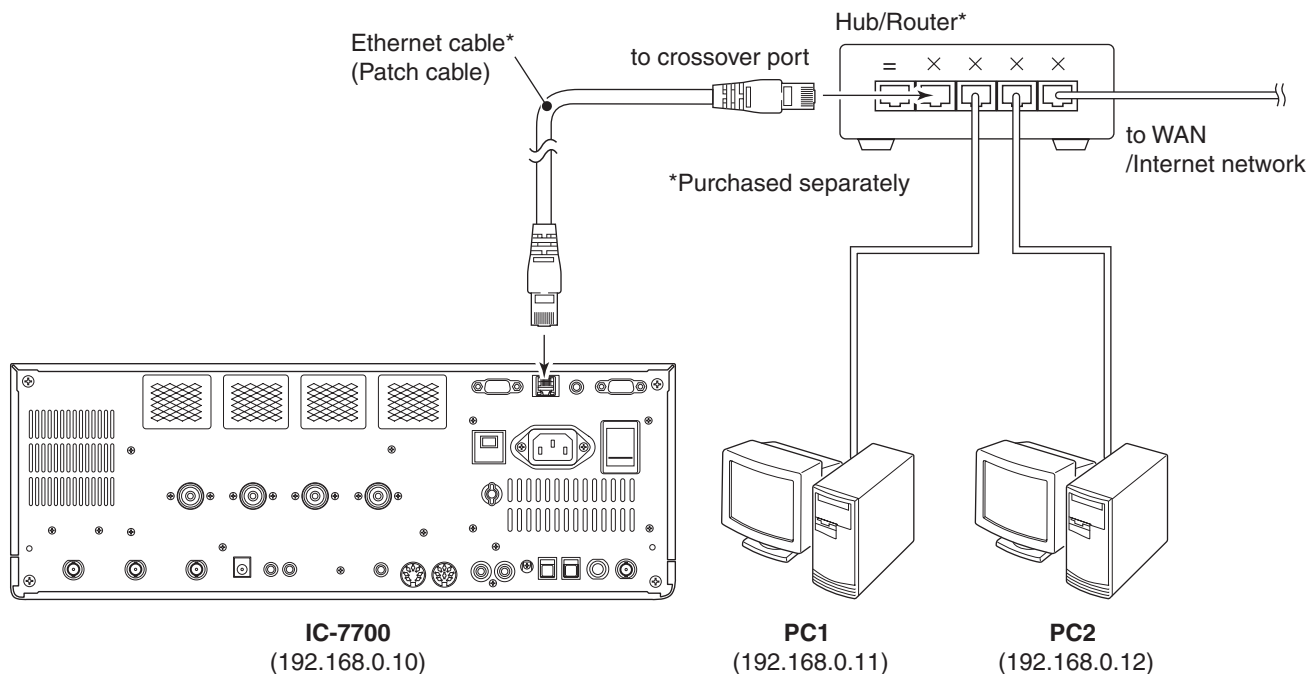

#### • IP address setting example

	IC-7700	PC1	PC2
IP address	192.168.0.10	192.168.0.11	192.168.0.12
Subnet mask	255.255.255.0	255.255.255.0	255.255.255.0



◇ IP address setting

When updating the firmware from the USB flash drive, the following settings are not necessary.

**IMPORTANT!** A fixed (static) IP address is used for the IC-7700.  
 When you connect the IC-7700 to a LAN, ask the network manager about a usable/assignable IP address and the subnet mask in advance.  
**NEVER** use an IP address that has already been used with another device in the network. If the IP address is duplicated, the network will crash.

- ① Push [EXIT/SET] several times to close a multi-function screen, if necessary.
- ② Push [SET] [F-7] to select set mode menu screen.
- ③ Push [OTHERS] [F-5] to select Others set mode.

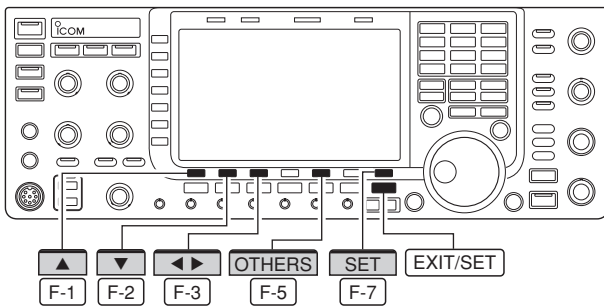

- ④ Push [▲] [F-1] or [▼] [F-2] several times to select "IP Address" item.
- ⑤ Push [◀▶] [F-3] to select the desired part then rotate the main dial to set the desired or specified IP address.
  - "192.168.0.10" is the default setting.
- ⑥ Push [▼] [F-2] to select "Subnet Mask" item.
- ⑦ Rotate the main dial to set the desired or specified subnet mask.
  - "255.255.255.0" is the default setting.
- ⑧ Push [POWER] to turn the transceiver power OFF, then ON to enable the IP address and subnet mask settings.

◇ Updating from a PC



- ① Start up the IC-7700 Firm Utility.
  - The window as at left appears.
- ② Read the caution in the window carefully.
- ③ Click [Yes] if you agree and continue the firmware updating.

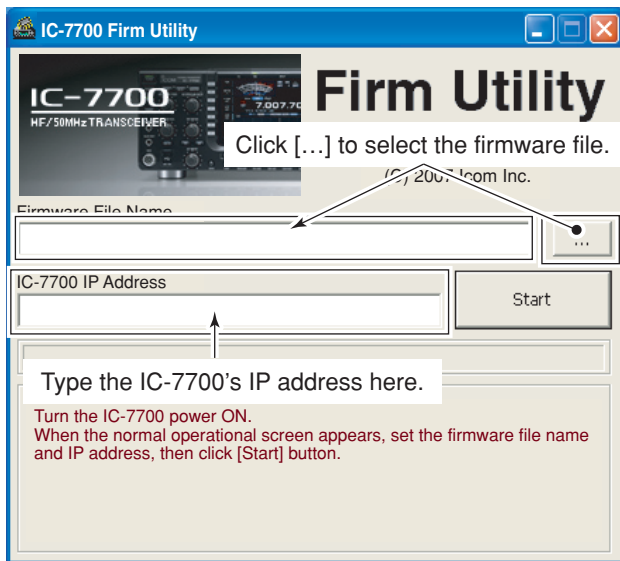

- ④ Select the firmware file, that has “dat” extension (example: 7700\_200.dat).
  - Click [...], then select the file, as well as the location.
- ⑤ Type the IC-7700’s IP address into “IC-7700 IP Address” text box.
- ⑥ Click [Start].

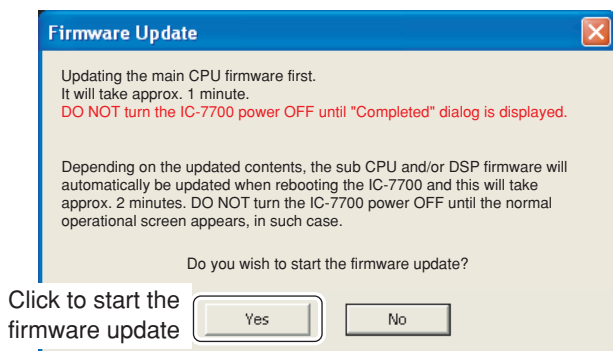

- ⑦ The window as at left appears.
  - Read the precaution in the window carefully.
- ⑧ Click [Yes] if you want to start the firmware update.

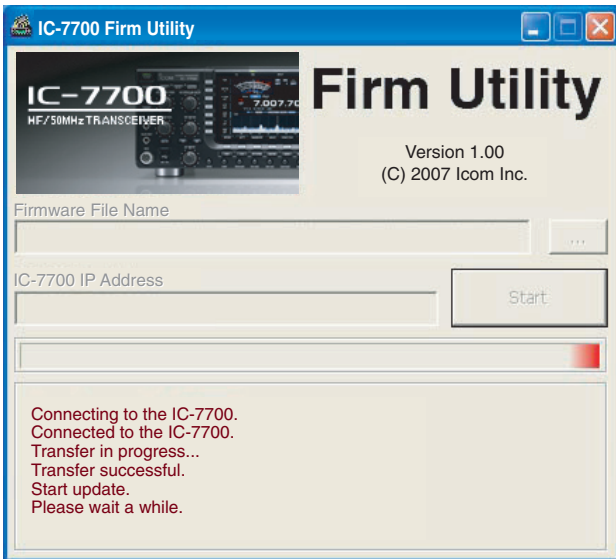

- ⑨ The screen as at left is displayed.
  - The following dialog appears in the IC-7700 display.

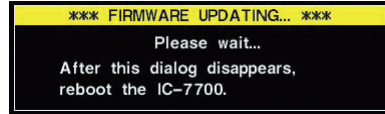

⚠ **WARNING! NEVER** turn the IC-7700 power OFF at this stage.  
 The transceiver firmware will be corrupted.

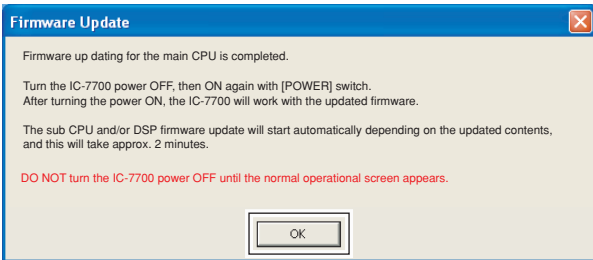

Click [OK] to finish the firmware update.

- ⑩ Click [OK] to finish the firmware update.
  - The “FIRMWARE UPDATING” dialog as above disappears.
- ⑪ Push **POWER** to turn the IC-7700 power OFF, then ON again.



- ⑫ Depending on the update, one or two dialog boxes as at left appear on the IC-7700 display in sequence.

⚠ **WARNING! NEVER** turn the IC-7700 power OFF at this stage.  
 The transceiver firmware will be corrupted.

- ⑬ After the dialog disappears, the firmware update is completed and normal operation screen appears.



## INSTALLATION NOTES

For amateur base station installations it is recommended that the clearance in front of the antenna array is calculated relative to the EIRP (Effective Isotropic Radiated Power). The clearance height below the antenna array can be determined in most cases from the RF power at the antenna input terminals.

Different exposure limits have been recommended for different frequencies, a relative table shows a guideline for installation considerations.

Below 30 MHz, the recommended limits are specified in terms of V/m or A/m fields as they are likely to fall within the near-field region. Similarly, the antennas may be physically short in terms of electrical length and that the installation will require some antenna matching device which can create local, high intensity magnetic fields. Analysis of such installations is best considered in association with published guidance notes such as the FCC OET Bulletin 65 Edition 97-01 and its annexes relative to amateur transmitter installations. The EC recommended limits are almost identical to the FCC specified 'uncontrolled' limits and tables exist that show pre-calculated safe distances for different antenna types for different frequency bands. Further information can be found at <http://www.arrl.org/>.

### • Typical amateur radio installation

Exposure distance assumes that the predominant radiation pattern is forward and that radiation downward is at unity gain (side lobe suppression is equal to main lobe gain). This is true of almost every gain antenna today. Exposed persons are assumed to be beneath the antenna array and have a typical height of 1.8 m.

The figures assume the worst-case emission of constant carrier.

For the bands 10 MHz and higher the following power density limits have been recommended:

10–144 MHz      2 W/sq m

### EIRP clearance heights by frequency band

1 Watts	2.1 m
10 Watts	2.8 m
25 Watts	3.4 m
100 Watts	5 m
1000 Watts	12 m

### Forward clearance, EIRP by frequency band

100 Watts	2 m
1000 Watts	6.5 m
10,000 Watts	20 m
100,000 Watts	65 m

In all cases any possible risk depends on the transmitter being activated for long periods. (actual recommendation limits are specified as an average during 6 minutes) Normally the transmitter is not active for long periods of time. Some radio licenses will require that a timer circuit automatically cuts off the transmitter after 1–2 minutes etc.

Similarly some types of emission, i.e., SSB, CW, AM etc. have a lower 'average' output power and the assessed risk is even lower.

 Versions of the IC-7700 which display the "CE" symbol on the serial number label, comply with the essential requirements of the Radio and Telecommunications Terminal Equipment Directive, 1999/5/EC, and the restriction of the use of certain hazardous substances in electrical and electronic equipment Directive, 2011/65/EU.

 This warning symbol indicates that this equipment operates in non-harmonised frequency bands and/or may be subject to licensing conditions in the country of use. Be sure to check that you have the correct version of this radio or the correct programming of this radio, to comply with national licensing requirement.

### • List of Country codes (ISO 3166-1)

	Country	Codes		Country	Codes
1	Austria	AT	18	Liechtenstein	LI
2	Belgium	BE	19	Lithuania	LT
3	Bulgaria	BG	20	Luxembourg	LU
4	Croatia	HR	21	Malta	MT
5	Czech Republic	CZ	22	Netherlands	NL
6	Cyprus	CY	23	Norway	NO
7	Denmark	DK	24	Poland	PL
8	Estonia	EE	25	Portugal	PT
9	Finland	FI	26	Romania	RO
10	France	FR	27	Slovakia	SK
11	Germany	DE	28	Slovenia	SI
12	Greece	GR	29	Spain	ES
13	Hungary	HU	30	Sweden	SE
14	Iceland	IS	31	Switzerland	CH
15	Ireland	IE	32	Turkey	TR
16	Italy	IT	33	United Kingdom	GB
17	Latvia	LV			



We Icom Inc. Japan  
1-1-32, Kamiminami, Hirano-ku,  
Osaka 547-0003, Japan

**Kind of equipment:** HF/50 MHz ALL MODE TRANSCEIVER

**Type-designation:** IC-7700

**R&TTE Directive**

Declare on our sole responsibility that this equipment complies with the essential requirements of the Radio and Telecommunications Terminal Equipment Directive, 1999/5/EC, and that any applicable Essential Test Suite measurements have been performed.

**Version (where applicable):**

This compliance is based on conformity with the following harmonised standards, specifications or documents:

- i) EN 60950-1:2006/A1:2010
- ii) EN 301 489-1 V1.9.2 (2011-09)
- iii) EN 301 489-15 V1.2.1 (2002-08)
- iv) EN 301 783-2 V1.2.1 (2010-07)
- v) EN 62311:2008
- vi)

**DECLARATION OF CONFORMITY**



**RoHS Directive**

Declare on our sole responsibility that this equipment complies with the restriction of the use of certain hazardous substances in electrical and electronic equipment Directive, 2011/65/EU.

Bad Soden 19th June 2013

**Place and date of issue**

Icom (Europe) GmbH  
Communication Equipment  
Auf der Krautweide 24, 65812  
Bad Soden am Taunus, Germany

**Authorized representative name**

Y. Furukawa  
General Manager

Signature

**Icom Inc.**

**DISPOSAL**



The crossed-out wheeled-bin symbol on your product, literature, or packaging reminds you that in the European Union, all electrical and electronic products, batteries, and accumulators (rechargeable batteries) must be taken to designated collection locations at the end of their working life. Do not dispose of these products as unsorted municipal waste. Dispose of them according to the laws in your area.

Please record the serial number of your IC-7700 transceiver below for future servicing reference:

**Serial Number** :

---

**Date of purchase** :

---

**Place where purchased** :

---

# Count on us!

IC-7700  
#13 (Europe-01)

<Intended Country of Use>	
<input checked="" type="checkbox"/>	AT
<input checked="" type="checkbox"/>	BE
<input checked="" type="checkbox"/>	CY
<input checked="" type="checkbox"/>	CZ
<input checked="" type="checkbox"/>	DK
<input checked="" type="checkbox"/>	EE
<input checked="" type="checkbox"/>	FI
<input type="checkbox"/>	FR
<input checked="" type="checkbox"/>	DE
<input checked="" type="checkbox"/>	GR
<input checked="" type="checkbox"/>	HU
<input type="checkbox"/>	IE
<input type="checkbox"/>	IT
<input type="checkbox"/>	LV
<input checked="" type="checkbox"/>	LT
<input checked="" type="checkbox"/>	LU
<input checked="" type="checkbox"/>	MT
<input checked="" type="checkbox"/>	NL
<input checked="" type="checkbox"/>	PL
<input checked="" type="checkbox"/>	PT
<input checked="" type="checkbox"/>	SK
<input checked="" type="checkbox"/>	SI
<input type="checkbox"/>	ES
<input type="checkbox"/>	SE
<input type="checkbox"/>	GB
<input type="checkbox"/>	IS
<input checked="" type="checkbox"/>	LI
<input type="checkbox"/>	NO
<input type="checkbox"/>	CH
<input checked="" type="checkbox"/>	BG
<input checked="" type="checkbox"/>	RO
<input type="checkbox"/>	TR
<input type="checkbox"/>	HR

IC-7700  
#14 (France-01)

<Intended Country of Use>	
<input type="checkbox"/>	AT
<input type="checkbox"/>	BE
<input type="checkbox"/>	CY
<input type="checkbox"/>	CZ
<input type="checkbox"/>	DK
<input type="checkbox"/>	EE
<input type="checkbox"/>	FI
<input checked="" type="checkbox"/>	FR
<input type="checkbox"/>	DE
<input type="checkbox"/>	GR
<input type="checkbox"/>	HU
<input type="checkbox"/>	IE
<input type="checkbox"/>	IT
<input type="checkbox"/>	LV
<input type="checkbox"/>	LT
<input type="checkbox"/>	LU
<input type="checkbox"/>	MT
<input type="checkbox"/>	NL
<input type="checkbox"/>	PL
<input type="checkbox"/>	PT
<input type="checkbox"/>	SK
<input type="checkbox"/>	SI
<input type="checkbox"/>	ES
<input type="checkbox"/>	SE
<input type="checkbox"/>	GB
<input type="checkbox"/>	IS
<input type="checkbox"/>	LI
<input type="checkbox"/>	NO
<input type="checkbox"/>	CH
<input type="checkbox"/>	BG
<input type="checkbox"/>	RO
<input type="checkbox"/>	TR
<input type="checkbox"/>	HR

IC-7700  
#15 (Italy-01)

<Intended Country of Use>	
<input type="checkbox"/>	AT
<input type="checkbox"/>	BE
<input type="checkbox"/>	CY
<input type="checkbox"/>	CZ
<input type="checkbox"/>	DK
<input type="checkbox"/>	EE
<input type="checkbox"/>	FI
<input type="checkbox"/>	FR
<input type="checkbox"/>	DE
<input type="checkbox"/>	GR
<input type="checkbox"/>	HU
<input type="checkbox"/>	IE
<input checked="" type="checkbox"/>	IT
<input type="checkbox"/>	LV
<input type="checkbox"/>	LT
<input type="checkbox"/>	LU
<input type="checkbox"/>	MT
<input type="checkbox"/>	NL
<input type="checkbox"/>	PL
<input type="checkbox"/>	PT
<input type="checkbox"/>	SK
<input type="checkbox"/>	SI
<input type="checkbox"/>	ES
<input type="checkbox"/>	SE
<input type="checkbox"/>	GB
<input type="checkbox"/>	IS
<input type="checkbox"/>	LI
<input type="checkbox"/>	NO
<input type="checkbox"/>	CH
<input type="checkbox"/>	BG
<input type="checkbox"/>	RO
<input type="checkbox"/>	TR
<input type="checkbox"/>	HR

IC-7700  
#16 (Spain-01)

<Intended Country of Use>	
<input type="checkbox"/>	AT
<input type="checkbox"/>	BE
<input type="checkbox"/>	CY
<input type="checkbox"/>	CZ
<input type="checkbox"/>	DK
<input type="checkbox"/>	EE
<input type="checkbox"/>	FI
<input type="checkbox"/>	FR
<input type="checkbox"/>	DE
<input type="checkbox"/>	GR
<input type="checkbox"/>	HU
<input type="checkbox"/>	IE
<input type="checkbox"/>	IT
<input type="checkbox"/>	LV
<input type="checkbox"/>	LT
<input type="checkbox"/>	LU
<input type="checkbox"/>	MT
<input type="checkbox"/>	NL
<input type="checkbox"/>	PL
<input type="checkbox"/>	PT
<input type="checkbox"/>	SK
<input type="checkbox"/>	SI
<input checked="" type="checkbox"/>	ES
<input type="checkbox"/>	SE
<input type="checkbox"/>	GB
<input type="checkbox"/>	IS
<input type="checkbox"/>	LI
<input type="checkbox"/>	NO
<input type="checkbox"/>	CH
<input type="checkbox"/>	BG
<input type="checkbox"/>	RO
<input type="checkbox"/>	TR
<input type="checkbox"/>	HR

IC-7700  
#17 (United Kingdom-01)

<Intended Country of Use>	
<input type="checkbox"/>	AT
<input type="checkbox"/>	BE
<input type="checkbox"/>	CY
<input type="checkbox"/>	CZ
<input type="checkbox"/>	DK
<input type="checkbox"/>	EE
<input type="checkbox"/>	FI
<input type="checkbox"/>	FR
<input type="checkbox"/>	DE
<input type="checkbox"/>	GR
<input type="checkbox"/>	HU
<input checked="" type="checkbox"/>	IE
<input type="checkbox"/>	IT
<input type="checkbox"/>	LV
<input type="checkbox"/>	LT
<input type="checkbox"/>	LU
<input type="checkbox"/>	MT
<input type="checkbox"/>	NL
<input type="checkbox"/>	PL
<input type="checkbox"/>	PT
<input type="checkbox"/>	SK
<input type="checkbox"/>	SI
<input type="checkbox"/>	ES
<input type="checkbox"/>	SE
<input checked="" type="checkbox"/>	GB
<input type="checkbox"/>	IS
<input type="checkbox"/>	LI
<input type="checkbox"/>	NO
<input type="checkbox"/>	CH
<input type="checkbox"/>	BG
<input type="checkbox"/>	RO
<input type="checkbox"/>	TR
<input type="checkbox"/>	HR

Icom Inc.

1-1-32 Kamiminami, Hirano-ku, Osaka 547-0003, Japan

Printed on recycled paper with soy ink.