

# TO CUSTOMERS

Thank you very much for using our two way radio.

This radio of modern design is reasonable structure with stable functions. It is designed to meet different customers' need for high quality with easy operation and perfect capability. We believe you are pleased with its nice shape and excellent performance.

This manual is suitable for using the model of MD-398.

Welcome to use **TYT** two-way radio

<http://www.tyt888.com>

## Main functions

Frequency band: VHF:136.000–174.000MHz

UHF:400.000–470.000MHz

1024 channels Conversely alarm

GPS function(Optional) IP67 waterproofed function

PC Programmed function Software online updating

VOX Chinese and English voice selection

CTCSS/DCS Busy channel lock

Battery save function TOT

High&Low Power selection Talk around function

Scanning function Lone work

Digital Encryption

Analog Wide/Narrow bandwidth selection

End-tone elimination

Emergency alert

High-low power

Key side setting

Record



# Cotents

Using tips .....	01
Unpacking and checking equipments .....	02
Installing and uninstalling of supplied accessories .....	03
Getting Familiar .....	07
Safety and Overview .....	10
Product safety and RF radiation for handheld two way radio .....	10
Overview .....	11
Switch On .....	11
Adjust Volume .....	11
Launch and Receive Calls .....	12
Zone Selection .....	12
Selection Of Channels , User ID Or Group ID .....	12
Receive And Reply Group Call .....	12
Receive And Reply The Single Call .....	13
Receive all calls .....	13
Launch a radio call .....	14
Using Channel Knob To Make A Call .....	14
Launch A Group Call .....	14
Single Call .....	15
All Call .....	15

Use Single key To Launch A Group Call Or Single Call .....	16
Emergency Function .....	18
Receive the Emergency Call .....	18
Reply the Emergency Call .....	18
Emergency Alarm .....	19
Logout Emergency Mode .....	19
Menu Operation .....	20
Character Input .....	20
English Typing .....	20
Chinese Typing .....	21
Numeral typing .....	21
Menu Application .....	21
Radio Check .....	22
Send Radio check .....	22
Monitor .....	23
Start Monitor .....	23
Contacts Setting .....	23
Group Call with Contacts .....	24
Private Call with Contact .....	24
Call Log .....	25
Missed Call .....	25
Message Function .....	26

Edit and Sending Message .....	26
Send Quick message .....	27
Send Quick Text with A Key .....	28
Forward Message .....	28
Editing message .....	29
Manage the Sent message .....	29
Check the sent message .....	30
Send the sent message .....	30
Receive Message .....	31
Check the Message .....	31
Manage Received Message .....	32
Check and Read the Inbox Message .....	32
Reply the Inbox Message .....	32
Deleting the Inbox Message .....	33
Deleting all Messages in the Inbox .....	34
Encryption .....	34
Basic encryption .....	34
DTMF .....	35
Secrecy .....	35
Radio Kill .....	35
Radio activate .....	36
Scan List .....	36

Scanning instructions and methods .....	36
Start and stop scanning .....	37
Scanning reply .....	37
<b>Settings</b> .....	<b>39</b>
Radio attributes .....	39
Radio configurati on .....	39
Transmitting frequency .....	40
Receiving frequency .....	41
Channel name .....	41
Channel name .....	42
Transmitting limit time .....	42
Color code .....	43
Repeater time slot .....	43
Power-on display Selct .....	43
Radio setting .....	44
Language selection .....	44
Lock Key setting .....	45
Turn on or off LED .....	45
Conversely Ann Setting .....	46
Set The Power Level .....	46
Zone Setting .....	47
Date & Time Setting .....	47

Date ..... 47  
Time ..... 48  
Date format ..... 48  
Tone Setting ..... 49  
Profiles ..... 49  
Keypad tone set ..... 50  
Power Tone set ..... 50  
Message Tones ..... 50  
GPS Setting ..... 51  
GPS information ..... 51  
RX GPS information ..... 51  
Specifications ..... 52  
Warranty card ..... 54

# Using tips & Unpacking and checking equipments

<http://www.tyt888.com>

## Using tips

- Please read the following brief instructions, non-compliance with these rules may cause danger or violate the law.
- Obey the local government regulation before using this radio, improper use may violate the law and be published.
- Turn off the radio before entering flammable or explosive areas
- Do not use radio whose antenna is damaged, touching of damaged antenna will cause heat injury
- Do not attempt to disassemble this radio; the maintenance work should be done by technical expert only.
- To avoid troubles caused by electromagnetic interference of electromagnetic compatibility, please turn off the radio in places where have the banner "Do not use wireless equipment", such as hospital and other healthcare places.
- In the car with an airbag, do not put the radio under the direct sunshine or in hot areas. When you transmit with the radio, do keep away from its antenna for 5cm at least.
- If the radio appears smelly or smoke, please shut off its power immediately and contact with your local dealer
- Do not transmit too long, for the radio may heat and hurt the user.

## Unpacking and checking equipments

Carefully unpacking the radio. We recommend you check the items listed in the following table before discarding the package. If any item is missing or has been damaged during shipment, please contact us immediately.

### Supplied accessories

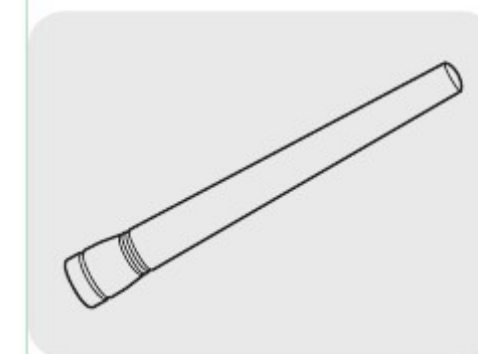

Antenna



Li-ion battery pack



Belt clip



Charger



Verification

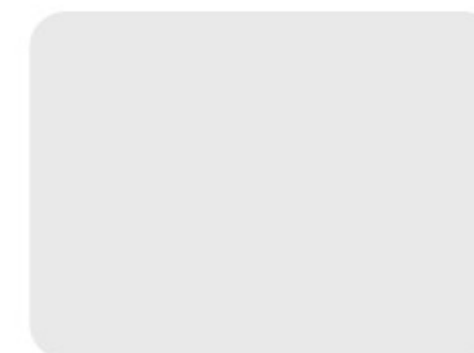

User 's manual

**Note:** The antenna frequency range please refers to the annular label at the bottom of antenna.

## Installing and uninstalling of supplied accessories

### Installing/Removing the battery

1. Align the two grooves of battery and the guide rail on the back of aluminum shell, ensuring full contact and in parallel, then push the battery up to the radio base along the rail on the back of aluminum shell, until the battery latch locks up.
2. To move the battery, please make sure the radio is closed, push the battery latch down, and then push the battery out from the radio.

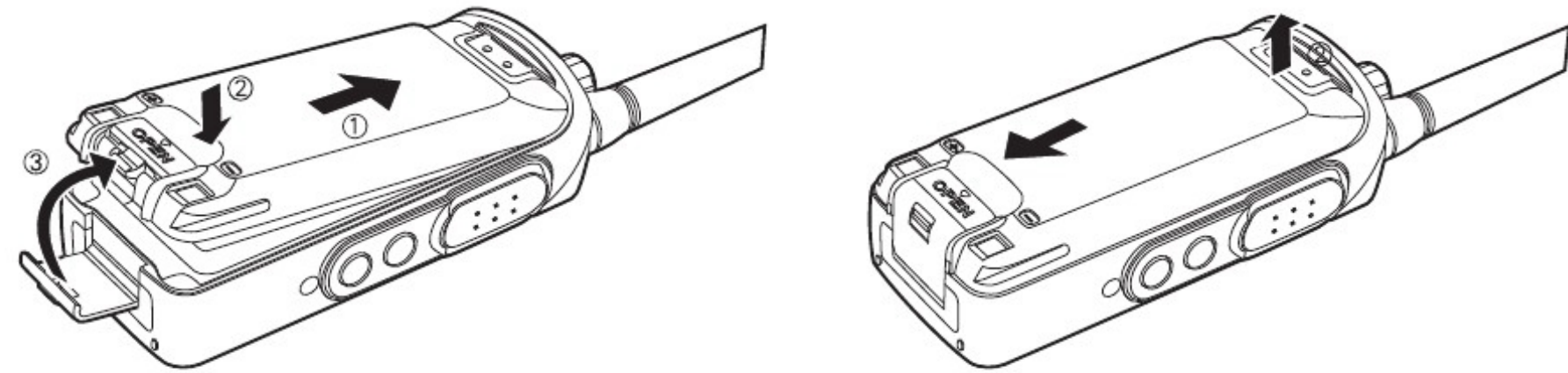

### Installing and removing the antenna

1. Align the threaded end of antenna and the treaded hole at the top of radio, rotate the antenna clockwise until it is tight.
2. To remove the antenna, rotate it counter-clockwise until the antenna spirals out.

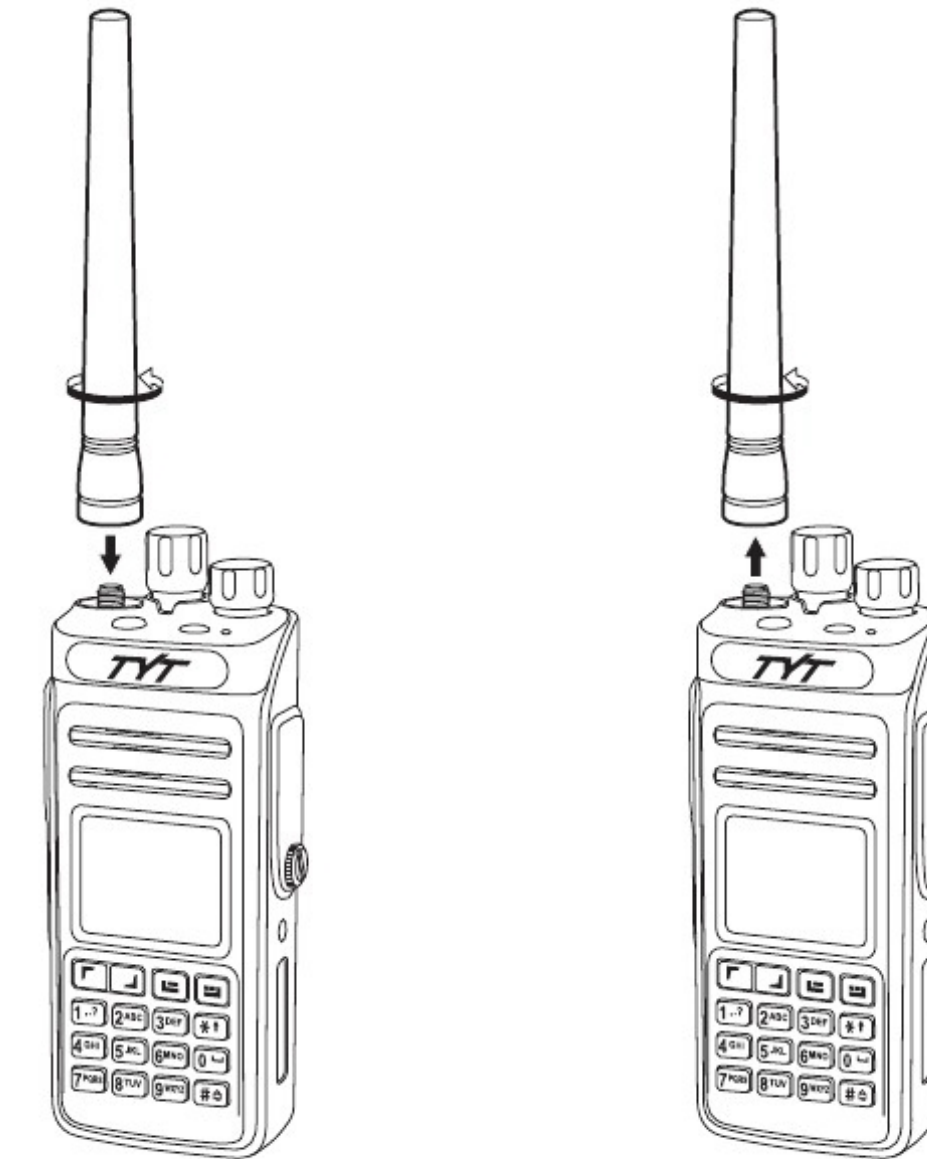

## Installing and removing the belt clip

1. Align the two holes of belt clip and the two holes of the radio, fix them with the supplied M2.5 X 5 screw.
2. Loosen the screw set to remove the belt clip

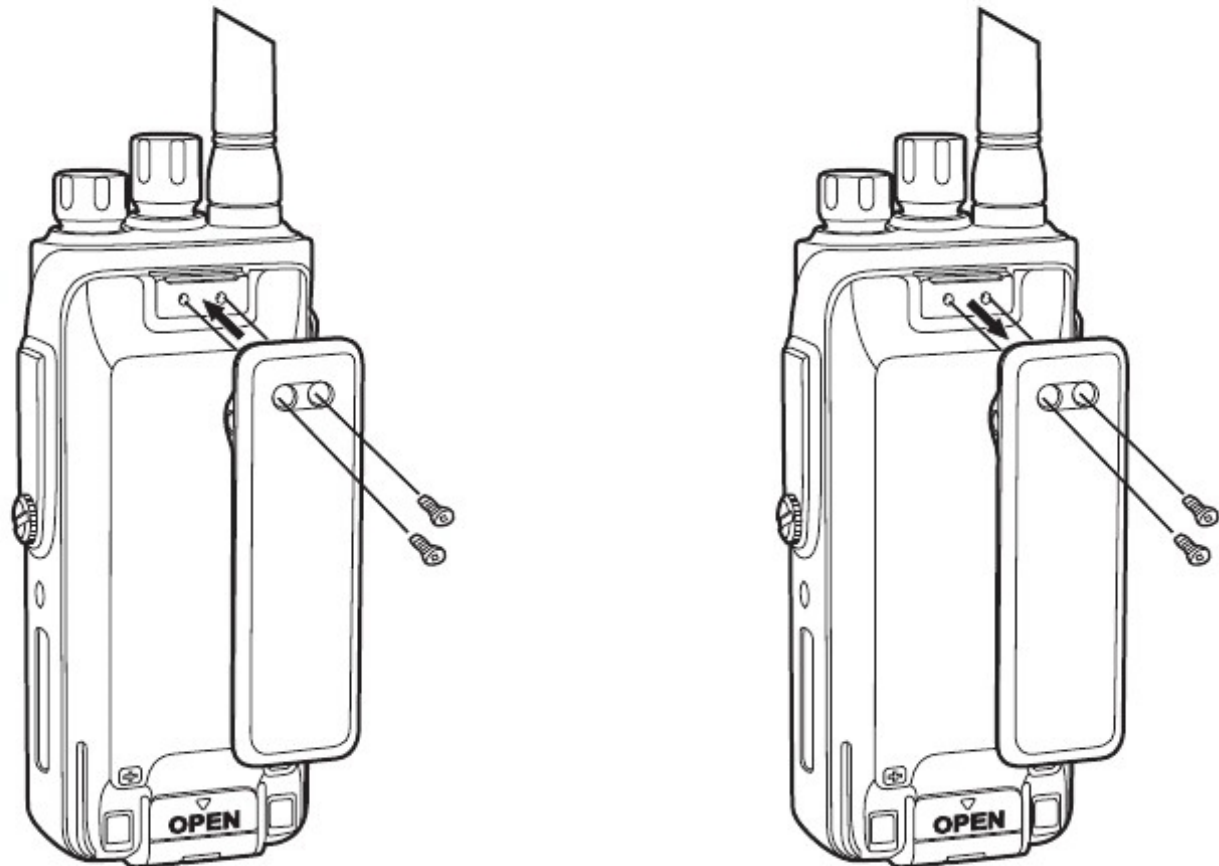

## Installing external headset

Reveal (do not remove) the mic/speaker jack cover, insert the headset into the mic/speaker jack.

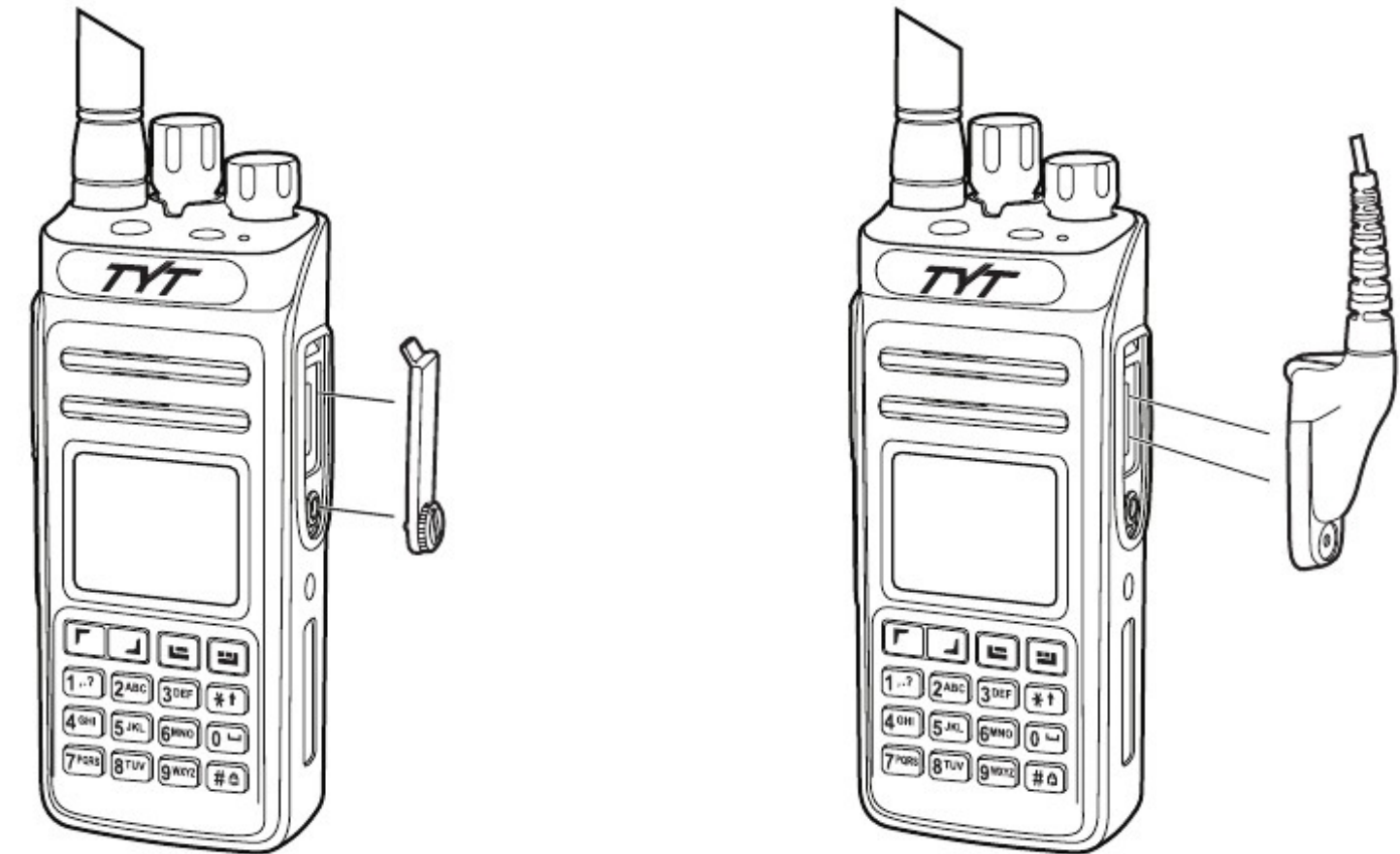



## Getting Familiar

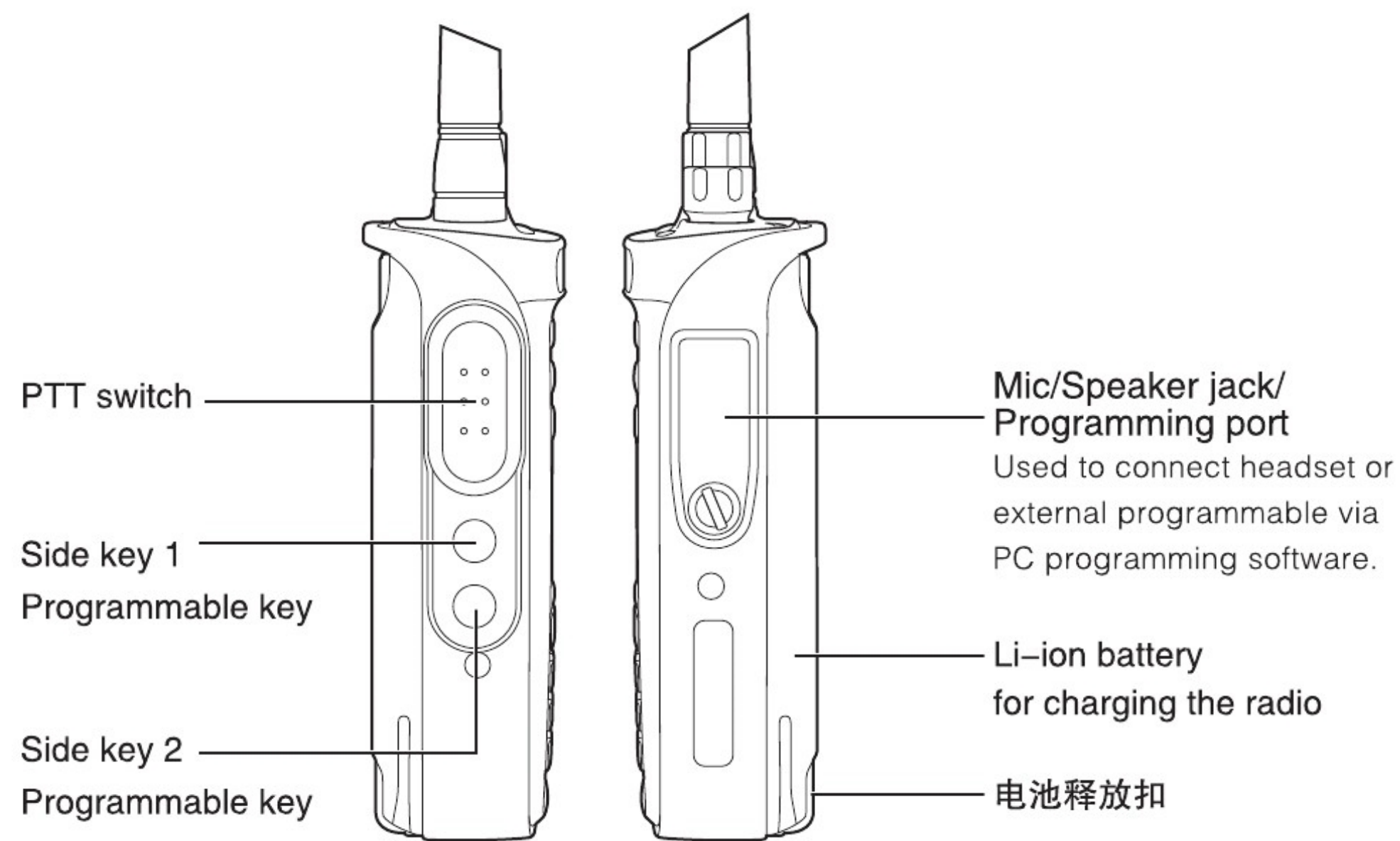
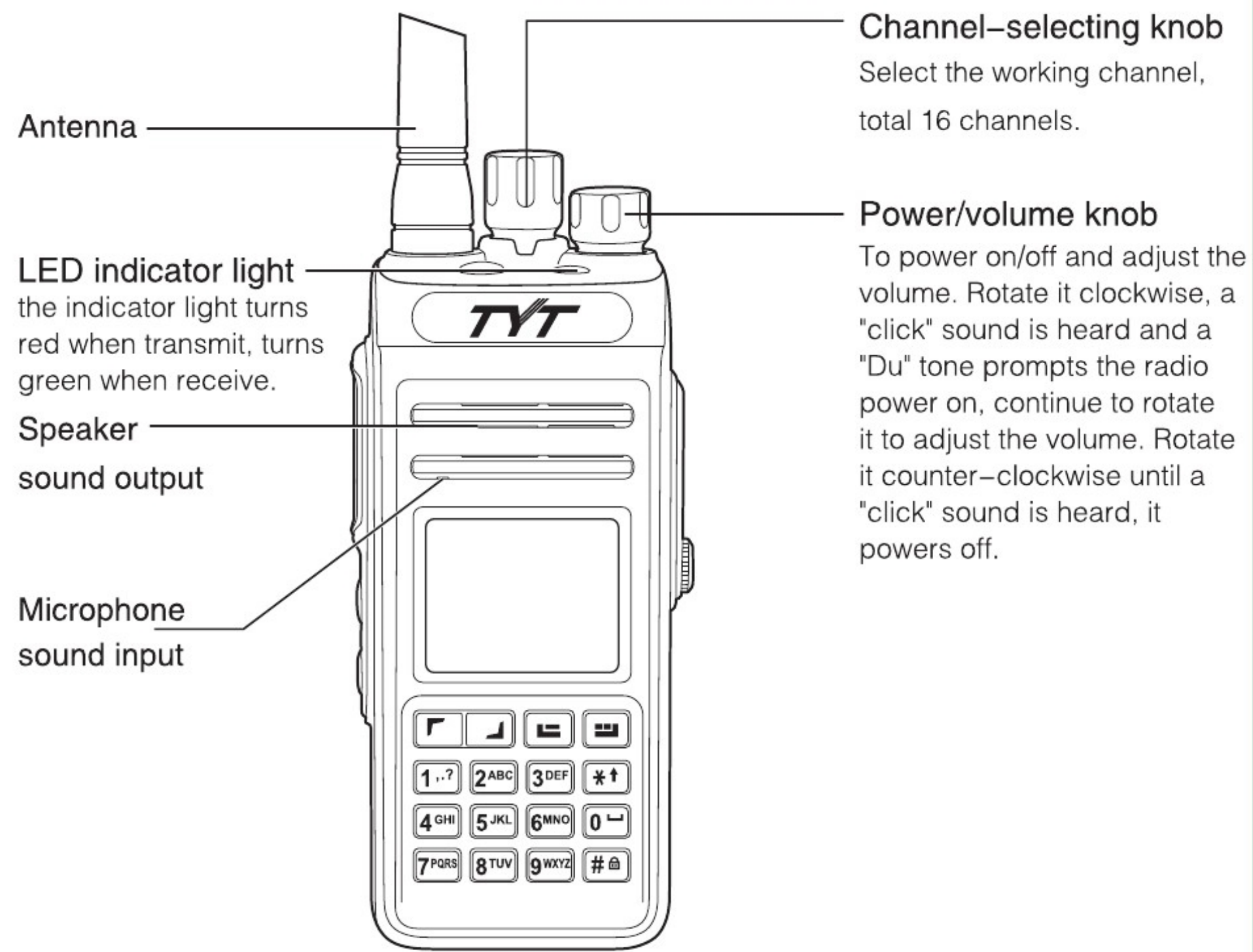

**Notice:** Either Long -press or Short-press of Side-key 1/Side-key 2/Side-key 3 can be set by program software for the following functions:

1. None-function
2. Radio activate
3. Radio check
4. Radio remote kill
5. High/low power selective
6. Monitor
7. All warning tone on/off
8. Zone selective
9. Scan on/off
10. VOX
11. PTT
12. PTT13. PTT
14. PTT
15. PTT
16. Error rate
17. Talk around
18. 1750 zone

# Safety and Overview Overview

## Launch And Receive Calls

<http://www.tyt888.com>

### Safety and Overview

#### Product safety and RF radiation for handheld two way radio.

Before using this two way radio ,please read the operational instructions carefully in the manual of product safety and RF radiation for safe usage of two way radio.



This two way radio can only satisfy the vocational applications for FCC RF energy exposure requirements. Before using this two way radio, Please read the operational instructions carefully in the manual of product safety and RF radiation for safe usage of two way radio for compliance with RF Energy Exposure limits in applicable national and international standards.

## Overview

### Switch On

Clockwise to turn on the radio volume knob there will be a "KADA" sound, message sound and the screen will show you "Welcome", while the LED indicator lights up and becomes Green color if the battery is full charged.

Notice: if all LED indicators are forbidden the screen will not light up when switch on the walkie talkie, but with a message sound.

Notice: if the volume function is forbidden, there will be no sound when power on. Now, need to power off the walkie talkie and anticlockwise to rotate the knob until a "KADA" sound.

### Adjust Volume







Clockwise the volume knob to higher the volume or anticlockwise to lower. And there shows a volume line on the screen.

## Launch and Receive Calls

### Zone Selection

Zones is a channel group. Each radio can set 64 zones and each zone with max 16 channels.

The menu function

1. Press [  ] key to enter the menu. Find out "Setting" in the menu "Settings", Then you can see "Zone".
2. Press [  or  ] key to zone after that with [  ] key to confirm
3. Screen shows current zone.
4. Press [  or  ] key to choose after then press [  ] key to confirm
5. Screen shows the chosen zone, Then back to the screen for the chosen zone.

### Selection Of Channels, User ID Or Group ID

Select the needed zone (if there are more than one zone), using the channel knob to select the channel, user name or ID, Or group name or ID.

### Receive And Reply Group Call

The radio must be under a group, then can receive the group call.

When receive the group call

1. LED indicator is green color.
2. On the top of the screen will show RSSI mark, Under it, The first line will show "group call", "private call" or "all call", The name of the caller will be shows in the middle, The

conversation time will be showed on the last line ( this happens only under Digital mode ).

3. Hold or keep the radio in a vertical position and place it between your lip within 2.5~5.0cm.

4. Press [PTT] key to answer the call LED indicator light change to red color.

5. Release [PTT] key to receive next call .

6. If there is no any transmitter within the time limited , the call failed .

### **Receive And Reply The Single Call**

Single call means one individual radio call to another individual radio. Only with two types:

The first type is the self testing part before rise a call , The second type is ready for immediate call .

When Receive The Single Call

1. LED indicator is green color

2. On the top of the screen will show RSSI mark follows shows single call user's name or ID in the middle The conversation time will be showed on the last line (Only for Digital mode ).

3. Hold or keep the radio in a vertical position and place it between your lip with 2.5~5cm.

If on the "free channel message sound" function let go [PTT] key , You can hear a message sound , That means this channel is free for you to answer .

4. Press [PTT] key to answer the call, LED indicator light change to red color.

5. Release [PTT] key to receive the call.

### **Receive all calls**

All call means a walkie talkie call up all other users in a channel to public an important notices.

When receive the all calls

1. LED indicator becomes green.

2. On the top of the screen will show RSSI mark follows shows all calls, User's name or ID in the middle, The conversation time will be showed on the last line (Only for Digital mode ).

3. End of the all calls, radio will back to the screen before receive all calls If under the "free channel message sound" function If you release the PTT key , you will hear a short message sound , That means this channel is free to use , but can't reply the all calls .

Notice: when receive the all calls , if you turn over to another channel the radio will stop to receive this all calls During the all calls You can't use any re-programmed key until the call finished .

### **Launch a radio call**

You can choose a channel , user ID or group call with following methods:

- Channel Knob
- Pre-programmed key
- Contact lists

### **Using Channel Knob To Make A Call**

#### **Launch A Group Call**

The radio should be under the group then can have the group call

1. Turn over channel knob , use an activated group name or ID to choose channel.

2. Hold or keep the radio in a vertical position and place it between your lip with 2.5~5cm.

3. Press [PTT] key to call LED indicator changes to red . Screen shows group name or ID .

4. Let go [PTT] key to receive ,when target radio is replying ,LED indicator becomes green. Screen shows group name or ID and Tx radio's name or ID.

5.when the walkie talkie back to home screen ,you can also make a group call using contact lists.

### Single Call

1. Turn over channel knob , use the activated name or user ID to choose channel .

2. Hold or keep the radio in a vertical position and place it between your lip with 2.5~5cm.

3. Press[PTT]key to callLED indicator changes to red . On the top of the middle screen will show RSSI markfollows shows single call, User name or ID in the middle(Only for Digital mode ).

4. Release [PTT] key to receive , when target radio is replying , LED indicator becomes green.

You can make a single call using contact lists for quick access to contacts and use keyboard to search the target walkie talkie to make a call.

### All Call

Walkie talkie must be programmed with this function , so that you can send information to every user who are under the channel .

1. Turn over channel knob , use the name or ID to choose channel.

2. Hold or keep the radio in a vertical position and place it between your lip with 2.5~5cm.

3. Press [PTT] key to release a call , LED indicator becomes to red color .Screen shows Group name or ID with all call mark .

User under the channel can not reply the all call .

### Use Single key To Launch A Group Call Or Single Call

Single key call function is convenient for you to set a name or ID for group call or single call with long–press or short–press the program key.

You can set a name or ID for a single key , Two way radios can have many programmed single call key .

1. Press pre–programmed call key, Can make a group all or single call to a predefine name or ID .

2. Hold or keep the radio in a vertical position and place it between your lip with 2.5~5cm.

3. Press [PTT] key to call , LED indicator becomes to red color .Screen shows group/user name or ID .

4. Let go[PTT] key to receive, when target walkie talkie is replying ,LED indicator changes to green .

# Emergency Function Menu Operation

<http://www.tyt888.com>

## Emergency Function

Emergency alarm only use to transfer emergency situations, you can release a emergency call at anytime and anywhere. Even the walkie talkie is busy in transferring or receiving.

Radio supports 3 types of emergency call:

- Emergency call
- Call follow emergency alarm
- A voice follow emergency alert

### Receive the Emergency Call

1. When receiving emergency call, number of received calls and alarms received, exchange the sender name or ID
2. With a message sound and LED indicator becomes red.
3. If the radio have activated, then will confirm the emergency alarm automatically.

When the radio receive the emergency alarm, screen shows the emergency alarm warning mark, until send with a confirm message then can logout. While, you will not receive any calls and notices from other radios during this situation.

Notice: short-press[]key, then with the pre-programmed off key, delete all received emergency call and logout the emergency mode.

### Reply the Emergency Call

When receiving the emergency call

1. Press[PTT] key to stop emergency call alarm
2. Hold the radio place it between your lip with 2.5–3cm.

3. Press[PTT] key to have a call. LED indicator becomes red. Walkie talkie under the emergency call mode.

4. Let go[PTT] key to receive, when reply the emergency, LED indicator becomes green. The screen shows group mark or ID and call ID.

### Emergency Alarm

This function called speech signal and allows to send emergency alarm and will trigger on another radio.

1. Press pre-programmed power on key.

2. Screen shows sending emergency call, exchange ID with other walkie talkie.

LED indicator changes to red and emergency call mark will down on the home screen.

3. When receive the emergency call, the radio issues the emergency call and LED indicator changes to red. LED shows emergency call and call ID.

### Logout Emergency Mode

The walkie talkie will logout emergency mode when any of the following situations happen:

1. Confirm with the received emergency call, or

2. Meet with the max emergency call, or

3. Press the pre-programmed call, or

4. Press [PTT]key.

Notice: Emergency mode will be logout when power off the walkie talkie. Radio will not under emergency mode when the radio is power on next time.

## Menu Operation

### Character Input

Users can use the 3X4 alphanumeric keypad to access the radio's function. When you're using the keypad to input a user alias or text messages, walkie-talkie input contains three modes: 1.English letter mode 2.Chinese input mode 3.Digital input mode.



When using the keypad input ID, you can only select the digital mode.

### English Typing:

Users have to press a button several times for getting some characters. The following table shows how many times needed to press a button to get the required character.

Bution	1	2	3	4	5	6	7	8	9	10	11	12	13
1	1	.	,	?	!	@	&	'	%	-	:	*	#
2	a	b	c	2	A	B	C						
3	d	e	f	3	D	E	F						
4	g	h	i	4	G	H	I						
5	j	k	l	5	J	K	L						
6	m	n	o	6	M	N	O						
7	p	q	r	s	7	P	Q	R	S				
8	t	u	v	8	T	U	V						
9	w	x	y	z	9	W	X	Y	Z				
0	0	Space											
*	*												
#	Press # to switch mode												



## Chinese Typing:

Number 1 is a button of punctuation/s selection input, number 2–9 are correspond Pinyin input, when user input something, the screen shows the Pinyin input interface, the first line of interface shows the contents inputted by user, the second line of interface shows Chinese character what user input. When the content of Pinyin input interface shows in the first line, users can press [  or  ]key to select Pinyin, press[  ]key to delete the Pinyin what they inputted previously one by one, after all Pinyin characters of inputted are deleted, the interface of Pinyin will disappears.

Press[  ] key to choose corresponding Chinese characters and display them in the editing area. At this time the Chinese character input finished, Pinyin inout interface disappears. Pressing "0" key shows space, press "#" to switch input modes.

## Numeral typing

When in the numbers input mode, press the number keys to display the corresponding number, press " #"key to switch input modes.

Note: When users enter a user alias, ID, or text messages, if editing area without any content, then the [  ] key is used for returning to the higher level menu, or else if there is any content on the editor area, pressing [  ]key will delete one character before the cursor at one time, until the editing area has no content, then press the [  ]key to return to the higher level menu.

## Menu Application

1. Press [  ] to enter Menu, then press left or right [  or  ]to access the menu function

2. Press [  ], select a function or go into a sub menu

3. Press [  ] to return the higher level menu

## Radio Check







If there are any activation, this feature allows you to determine whether there is other two way radio active inside the system, and does not disturb the walkie talkie users, none-voice or visual appears on the target two way radio.

Note: This function only apply to private call.

## Send Radio check

1. Press [  ]key to enter menu

2. Press [  or  ]key to select Contacts, then press [  ]key to select.

3. Press [  or  ] to the required user alias or ID, then press [  ] to select or press [  or  ]key to manual dialing, and then press [  ]key to select. If there are before calling ID, show ID and along with the flashing cursor, using the keyboard editing ID, press [  ].

4. Press [  or  ] to radio detection, and then press [  ] to select

5. When screen displays radio detection: < use alias or ID>, it is indicating the ongoing radio detection.

6. Waiting for confirmation

7. If the target radio is active in the system, then it makes a prompt sound, screen will shows success, or if is inactive, then it makes a prompt sound, screen will shows "fail"

8. Two way radio returns to user alias or ID screen. If you press [  ] when waiting for confirmation, made a prompt, two way radio will end all retry and exit the two way radio detection mode.



## Monitor

Using monitoring function to open the target two way radio microphone ( only the user alias or ID ). You can use the function to monitor any sound around target two way radio. You must allow your two way radio to use this function by programming it.

This function only apply to private call

### Start Monitor

Using the Menu:

1. Press [M] to enter the menu
2. Press [F or J]key to select Contacts, then press [M]key to select.
3. Press [F or J] to the required user alias or ID, then press [M]key to select
4. Press [F or J] to select Remote Monitor then press [M] to select
5. Two way radio makes a prompt sound.
6. Waiting for confirmation
7. Screen displays Monitor succeeded,  
Or screen displays Monitor failed
8. If succeeded: two way radio began to receive voice signals from the radio which are being monitored voice and screen displays two way radio are monitoring, until the end of the duration of the preprogrammed, two way radio made a prompt sound, and the LED light puts out, screen display that monitoring ends.

If failed: two way radio repeats until reach the preprogrammed attempts.

### Contacts Setting

Contacts is "address book" for handheld two way radio. Each entry correspond to an alias or ID used to start the call. In addition, each item, according to the different content setting, relate to there types of call: group call, single call, all call. Your radio support digital address booking.

### Group Call with Contacts

Note: the difference between private call icon, group call icon and all call icon

1. Press [M]key to enter Menu
2. Press [F or J] to contacts, then press [M] to choose, entries arrange in alphabetical order.
3. Press [F or J] to required calling group\*s alias or ID.
4. Hold the radio and let it in a vertical position and keep mouth 1 to 2 inches (2.5 to 5.0cm) with radio.
5. Press [PTT] key to start calling, the LED light turns red. The screen displays the calling group's alias or ID.
6. Releasing [PTT]key to receive, when any user response within the group, the LED light turns green. You will see on screen group call icon of user 's ID
7. If you enable the "Channel Free Prompt" function, when the target radio release the [PTT]key, you will hear a short beep, said this channel is idle, waiting for your answer. Press the call key (PTT) to answer. If in a preprogrammed group called hang time without voice activity, the call is ended.

### Private Call with Contacts

Note: the difference between private call icon, group call icon and all call icon

1. Press [☰]key to enter Menu
2. Press [↵ or ↩] to contacts, then press [☰] to choose, entries arrange in alphabetical order.
3. Press [↵ or ↩] to required calling alias or ID.
4. Holding the radio and let it in a vertical position and keep mouth 1 to 2 inches (2.5 TO 5.0cm) with radio
5. Press [PTT]key to start calling, the LED light turns red.
6. Releasing [PTT]key to receive, when the target radio response, the LED light turns green.

You will see on the screen target radio call icon of ID

Note: If you release [PTT]key when you are setting up the call, and it will exit and return to the previous screen without any remind.

## Call Log

Your radio can record all the recent dialed, received, and missed calls.

### Checking New Call's Number

1. Press [☰]key to enter the Menu.
2. Press [↵ or ↩]key to the Call Log, and then press [☰]key to choose.
3. Press [↵ or ↩]key to dialed calls, and then press [☰]key to choose.
4. The top of the list on the screen shows the recent entries.

## Missed Call

Whenever you miss call, two way radio will display a not answered call, you can view in the

Call Log.

### Deleting Calling Log's Record

1. Press [☰]key to enter the Menu,
2. Press [↵ or ↩]key to the Call Log, and then press [☰]key to choose.
3. Press [↵ or ↩]key to the Dialed Numbs, and then press [☰]key to choose.
4. Press [↵ or ↩]key to required alias or ID, and then press [☰]key to choose.
5. Press [↵ or ↩]key to delete the entries, then press [☰]key to select if you need delete this entry.
6. Select "ok", then press [☰]key to delete the entries, screen appears entry deleted; or select "back", press [☰]key to return previous screen.

When you select a call list but there is no entry in, the screen will display the list is empty.

## Message Function

Your radio can receive data, such as from another radio sent text messages, message of a maximum length is 144 characters.

## Edit and Sending Message

### Using the Menu

1. Press [☰] key to enter the menu mode.
2. Press the [↵ or ↩] key to message, and then press [☰] key to choose.
3. Press [↵ or ↩] key to text message, and then press [☰] key to choose.
4. A flashing cursor appears, using the keyboard to input messages, press [↵] key to move to the left one, press[↩] button to the right one, when editing area have content,

press the [\*↑] key to delete any useless character, otherwise when editing area without content to return to the higher level menu.

5. After writing the text, press [↵] to choose to send or save.

6. When on the process of editing, user can choose by pressing the [↵] key to empty option to empty all the content of the editor, quickly return to the higher level menu.

7. Choose the [↵ or ↵] key to required alias name or ID, and then press [↵] key to select .

Or press [↵ or ↵] key to manual dialing, and then press [ ] button, enter your user ID and press [↵] key.

8. The screen shows message: < user/group name or ID > call, sending message are being confirmed.

9. If the messages sent successfully, the screen will displays text message has been sent.

### Send Quick message

Two way radio support maximum 16 programming of prefabricated text messages by the agent:

When a predefined text message, you can edit every message before you send each message.

Using the Menu:

1. Press [↵]key to enter the Menu

2. Press [↵ or ↵] key to message, and then press key to choose.

3. Press [↵ or ↵] key to Quick Text, and then press[↵]key to choose.

4. Press [↵ or ↵] key to required quick text, press [↵]key to choose.

5. A flashing cursor appears, using the keyboard to input messages, press [↵]key to

move to the left, press [↵]key to move to the right, when editing area have content, press [\*↑]key to delete any useless character otherwise when editing area without content to return to the higher level menu.

6. After writing the text message, press [↵]key to choose to send or save.

### Send Quick Text with A Key

1. Press preprogrammed, single bond calls to a predefined alias or ID sends a prefabricated text messages.

2. The screen displays a text messages: <user/group name or ID> call, to confirm text messages were being sent.

3. If the messages sent successfully, the screen will displays text message has been sent. Or if you cannot send text messages, screen displays text message sent failure. If message sent failure, intercom chance to return to the retransmission selection screen.

### Forward Message

Choose to forward message to another User/group name or ID.

1. Press the [↵ or ↵] key to forward, and then press [↵] key choose.

2. Press the [↵ or ↵] key to the alias name or ID, and then press [↵]key to choose.

Or press [↵ or ↵] key to manual dialing, and then press [↵] key to choose, enter your user ID and press [↵] key.









3. The screen display a text message: < user/group name or ID > call, to confirm text messages were being sent

4. If the messages sent successfully, the screen will displays text message has been sent.

## Editing message

Choosing edit to edit message before you edit.

Note: if you have a subject line (receive text messages from email program ), you can't edit the subject line.

1. Press key to edit, then press [  or  ] key to choose
2. A flashing cursor appears, using the keyboard to input messages, press [  ] key to move to the left one, press [  ] button to the right one, when editing area have content , press the [  ] key to delete any useless character, otherwise when editing area without content to return to the higher level menu.
3. After writing the text, press [  ] choose to send or save
4. After choose send, press [  or  ] to required alias or ID, and then press [  ] key to choose.
5. Screen displays message: < user/group name or ID > call, to confirm text messages were being sent
6. If the messages sent successfully, the screen will displays text message has been sent.











## Manage the Sent SMS

Once a message is sent to another radio, it will be saved in the "Outbox". Send after sending a text message has always been to "Outbox" at the top of the list. The "Outbox" folder can store up to 20 recently send text messages. After the folder is full, the next send text messages will automatically replace the earlier messages in this folder.

Note: at any time pressing the [  ] key can return to the previous screen.





## Check the sent message

Using the menu function:

1. Press [  ] button to enter the menu mode.
2. Press [  or  ] the key to message, and then press [  ] key to choose
3. Press [  or  ] to Outbox, and then press [  ] key to choose
4. Press [  or  ] the key to the required message, and then press [  ] key choose. If the message from the email program, a subject lines will appear, in the top right corner of the screen icon indicates state of SMS.

## Send the sent message

When the view sent messages, you can choose the following options:

- Resend
  - Forward,
  - Edit
  - Delete
1. Check the message, press [  ] key again
  2. Press the [  or  ] key to resend, then press [  ] key to choose.
  3. The screen displays: < user/group name or ID > call, confirm that it is preparing to send the same message to the same target radio
  4. If the messages sent successfully, the screen will displays text message has been sent. Select contacts, send the required message to user/group name or ID. Select edit, editing the required message before send,

Select delete, deleting required message.

Using Menu:

1. Press [⏏]key to enter the menu
2. Press [↵ or ⏏] the key to message, and then [⏏]key to choose,
3. Press [↵ or ⏏] the key to delete message, and then [⏏]key to choose
4. Press [↵ or ⏏] the key to outbox, and then press [⏏]key to choose.
5. The screen will displays "are you sure", press [⏏]key to delete all message of outbox.

### Receive Message

When your radio are receiving message, the left of the screen shows the sender alias or ID icons and messages.

When receiving messages, you can choose the following options,

- Reading
- Backing

### Check the Message

1. Press [↵ or ⏏] the key to Read, And then press [⏏] key to choose
2. The selected text messages on the inbox opened, if the message is from the email program, it will appear a subj ect line.
3. Click [⏏] key to return to your inbox.

Or press [⏏] to reply, forward or delete messages.

Press [↵ or ⏏] key to enter later view or delete selection screen:

Choose read later and return the screen before receive the message.

Choose delete, delete receive text messages.

### Manage Received Message

Use your inbox to manage messages. inbox can store up to 20 text messages at Most.

Two way radio supports the following text options:

- Reply,
- Forward,
- delete

Store the message in the inbox in the order of received time .

Note: At any time according to the [⏏] key can return to the previous screen.

### Check and Read the Inbox Message

1. Press the [⏏] button to enter the menu mode.
2. Press the [↵ or ⏏] key to Message, and then press [⏏] key to choose
3. Press [↵ or ⏏] to the inbox, and then press [⏏] key to choose.
4. Press the [↵ or ⏏] key to check the message. If the messages are from the email program, it will appear a subj ect line.
5. Press the [⏏] key to choose the current text, then press [⏏] key again to reply, delete, or forward this message.

Unread messages:  , .Already read message: 

### Reply the Inbox Message

Use the menu function:

1. Press [⏏] key to enter the menu mode.
2. Press the [↵ or ⏏] key to message, and then press [⏏] key to choose

3. Press [↵] or [↩] to the inbox, and then press [↵] key to choose
4. Press the [↵] or [↩] key to the required message, and then press [↵] key to choose. If the messages are from the email program, it will appear a subject line.
5. Press again [↵] key to enter submenu.
6. Press to reply, and then press [↵] key to choose.
7. Press to write messages, and then press [↵] key to choose, a flashing cursor, using a keyboard editing text messages.  
Or press [↵] or [↩] key to prefabricated text messages, and then press [↵] key to choose. Choose the required message after press [↵] a flashing cursor, if needed, with the keyboard editing your message.
- 8 After writing the text, press [↵].
9. The screen displays message : < user/ call group name or ID >, to confirm text messages were being sent
10. If the messages sent successfully, the screen display text message has been sent.

### Deleting the Inbox Message

Use the menu function:

1. Press the [↵] key to enter the menu mode.
2. Press the [↵] or [↩] key to message, and then press [↵] key to choose
3. Press [↵] or [↩] to the inbox, and then press [↵] key to choose
4. Press the [↵] or [↩] key to the required message, and then press [↵] key to choose. If the messages are from the email program, it will appear a subject line.

5. Press again [↵] key to enter submenu.
6. Press the [↵] or [↩] key to delete, and then press [↵] key to choose.
7. Delete messages, the screen will display "are you sure" , then press [↵] key to choose ok.
8. Screen appears short message has been deleted.
9. The screen back to inbox.

### Deleting all Messages in the Inbox

Use the menu function,

1. Press [↵] key to enter the Menu
2. Press [↵] or [↩] key to message, and then press [↵] key to choose.
3. Press [↵] or [↩] key to the delete message, and then press [↵] key to choose.
4. Press [↵] or [↩] key to inbox, and then press [↵] key to choose.
5. The screen will appears "are you sure", press [↵] key to delete all messages, press [↵] to back.

### Encryption

If you enable this feature, which is beneficial to prevent other users on the channel by using the method of software encryption for unauthorized eavesdropping. The launch of signaling and user identification part unencrypted. Your radio must be enabled on the channel encryption function, can send encrypted, even if the receiving transmission is not must request to do so.

### Basic encryption

Two way radio can only be assigned more than one type of encryption. If users Call for encryption or decryption of data transmission, must make to be preprogrammed walkie-

talkies and launch radio has the same "encryption keys" (suitable for basic encryption). If your radio to receive different encryption keys or key values and key encryption call ID, you will hear the sound of the transport chaos encryption (basic).

Press the preliminary programming encryption keys on or off.

### **DTMF**

Dual Tone Multi-Frequency (DTMF) function allows operating radio when there is interference in the radio system.

To initiate a DTMF call Setting the Coding sequence table from programming software, support 16 groups most.

You can set the code sending before PTT transmitter and after PTT transmitter, the duration time and the interval time of DTMF code sending,

You can disable DTMF tone by turning off all radio tone and prompts.

### **Secrecy**

You can activate or kill any radio in the system. For example, you might want to disable a stolen radio, to prevent thieves use it, and enable it when you get it back.

Note: radio kill or activation is limited to activate the radios with these functions.

### **Radio Kill**

This function only applies to private call.

- 1.Via programming software to edit radio kill function to side key.
- 2.Via programming software to make the radio can use radio kill function.
- 3.Via programming cable to choose the private call ID
- 4.If successful, emit a beep and the screen displays radio kill successfully. Or if it fails,

emit a beep and the screen displays radio fail to kill.

During radio kill operation, do not press the [PTT] key, because you will not get a confirmation message.

### **Radio activate**

This function only applies to private call.

- 1.Via programming software to edit radio kill function to side key.
- 2.Via programming software to make the radio can use radio kill function.
- 3.Via programming cable to choose the private call ID.

### **Scan List**

Create a scan list and assign to a single channel/talk group, your radio can support up to 16 scan lists, each up to 16 members. Each scan list support mixed analog and digital channels. You can edit the scan list to add / delete channels or set the priority channel.

### **Scanning instructions and methods**

When scanning, your radio can view if there is a voice activity in current channel through circulating pre-programmed scan list. LED lights flashing for a red light.

When scanning in dual mode, if you're in a digital channel and your radio locking an analog channel, radio will switch automatically from digital mode to analog mode throughout the duration of the call. And vice versa.

There are two scanning methods

- Manual Scan: According to a pre-programmed scan on / off key to start the scan, when you start scanning, radio will detect all channels/contact groups on pre-programmed scan list.

● Auto Scan: When you select an already activated auto scan channels / contact groups, radio scans from the activated auto scan channel.

### Start and stop scanning

Press Pre-programmed scan on / off key or enter the scan menu function

When the scan is activated, LED indicator flashes red and displays scan icon ; or when scanning is disabled, LED light goes out and does not display the scan icon.

### Scanning reply

Radio detect active channel/contact group when scanning, at this time radio will stay in the channel/ contact group, which is called "Scan hang time" pre-programmed time.

Procedure:

1. Hold the radio in a vertical position and keep 1 to 2 inches (2.5 to 5.0 cm) distance from the mouth.
2. Within the hang time by pressing [PTT]key, LED indicator light is red.
3. Release [PTT] key to respond.
4. If you do not respond within the hang time, radio will continue down the scan.

# Settings

## Technical Parameters

<http://www.tyt888.com>



## Settings

Settings includes the following contents:

- Attributes
- Configuration
- Settings
- GPS information
- Receive GPS information

### Radio attributes

Attributes includes the following contents:

- Serial Number
- Version Number

Serial Number

- Shows the radio's ID

Version Number

- Shows the firmware's version NO .

### Radio configuration

Including the following contents:

- Transmitting frequency
- Receiving frequency
- Channel Name

- squelch grade/level
- Transmit limit time
- Color code
- Time slot
- Power-on display Selct

### Transmitting frequency

1. Press [⏏] key to enter the menu mode.
2. Press [↵] or [⏏] key to Settings, and then press [⏏] key to select .
3. Press [↵] or [⏏] key to radio configuration, and then press [⏏] key to select .
4. Press [↵] or [⏏] key to transmitting frequency, and then press [⏏] key to select .
5. The screen displays transmitting frequency of the current channel , and then press [⏏] key to select .
6. Press the number keys to enter the corresponding number, press [\*] key to delete the last number, press [⏏] to return to the previous menu.
7. After finish the change, press [⏏] key, the screen displays transmitting frequency has been saved.

Note: Editing frequency will be limited within the frequency range set by programming software, if less than the write frequency range set by software, the final change result will be the minimum frequency of frequency range set on software, otherwise it is maximum

## Receiving frequency

1. Press [⏻] key to enter the menu mode.
2. Press [↵] or [⏴] key to Settings, and then press [⏻] key to select.
3. Press [↵] or [⏴] key to radio configuration, and then press [⏻] key to select.
4. Press [↵] or [⏴] key to receiving frequency, and then press [⏻] key to select.
5. The screen displays transmitting frequency of the current channel, and then press [⏻] key to select.
6. Press the number keys to enter the corresponding number, press [\*↑] key to delete the last number, press [⏻] to return to the previous menu.
7. After finish the change, press [⏻] key, the screen displays transmitting frequency has been saved.

Note: Editing frequency will be limited within the frequency range set by programming software, if less than the write frequency range set by software, the final change result will be the minimum frequency of frequency range set on software, otherwise it is maximum.

## Channel name

1. Press [⏻] key to enter the menu mode.
2. Press [↵] or [⏴] key to Settings, and then press [⏻] key to select.
3. Press [↵] or [⏴] key to radio configuration, and then press [⏻] key to select.
4. Press [↵] or [⏴] key to the channel name and press [⏻] key to select.
5. The screen displays the current channel name, press the [#] key to switch the input method to enter the relevant letters, numbers or characters, the same as the input method

for text editing.

6. After the change is completed, press [⏻] key, the screen displays channel name has been saved.

## Channel name

You can adjust radio's squelch level, thus filtering low signal intensity useless call or channels which background noise higher than normal value.

Setting: Normal is the default, strict filtering (useless) call or background noise. However, a call from a remote location may also be filtered out.

Using the menu function:

1. Press [⏻] key to enter the menu mode.
2. Press [↵] or [⏴] key to Settings, and then press [⏻] key to select.
3. Press [↵] or [⏴] key to radio settings, and then press [⏻] key to select.
4. Press [↵] or [⏴] key to squelch level, and then press [⏻] key to select.
5. Press [↵] or [⏴] key to choose the level from 0 to 9, and then press [⏻] key to select.
6. The screen returns to the previous menu.

## Transmitting limit time

1. Press [⏻] key to enter the menu mode.
2. Press [↵] or [⏴] key to Settings, and then press [⏻] key to select.
3. Press [↵] or [⏴] key to radio configuration, and then press [⏻] key to select.
4. Use the keypad to enter the correct radio configuration password (programmed by software), and then press [⏻] key to select.

5. Press [**F** or **J**] key to transmitting limit time, and then press [**E**] key to select.
6. The screen displays infinite,30S ... and other options (increasing 30S each time), press [**F** or **J**] key to the corresponding option, then press [**E**] key to select; if you choose infinite, the screen displays transmit time close, if you select others, the screen display corresponding time selected.

### Color code

Color code only can be set on digital channels.

1. Press [**E**] key to enter the menu mode.
2. Press [**F** or **J**] key to Settings, and then press [**E**] key to select.
3. Press [**F** or **J**] key to radio configuration, and then press [**E**] key to select.
4. Press [**F** or **J**] key to color code, then press [**E**] key to select.
5. Press [**F** or **J**] key to select color code values, and then press [**E**] key to select. Screen shows X(the selected color code value) is selected.

### Repeater time slot

Repeater slot only can be set on digital channels.

This radio have only one slot

### Power-on display Selct

You can select display when power-on ,None, Picture , Word and All.

1. Press [**E**] key to enter the menu mode.
2. Press [**F** or **J**] key to Settings, and then press [**E**] key to select.
3. Press [**F** or **J**] key to radio configuration, and then press [**E**] key to select.

4. Press [**F** or **J**] key to Dis Selct, then press [**E**] key to select.
5. Select the display mode you want.
6. Then press [**E**] key to select. Screen shows "Dis set".

### Radio setting

- Language
- Lock Key
- Led
- Converse LyAnn
- Power
- Zone
- Data &Time
- Tone
- GPS

### Language selection

This radio support the following languages:

- Chinese
  - English
1. Press [**E**] key to enter the menu mode.
  2. Press [**F** or **J**] key to Settings, and then press [**E**] key to select.
  3. Press [**F** or **J**] key to radio setting, and then press [**E**] key to select.
  4. Press [**F** or **J**] key to the language selection, then press [**E**] key.

5. Press [F] or [J] key to the corresponding language option, then press [E] key.
6. Screen displays to select corresponding language, and then jump back to the main interface.

### Lock Key setting

You can lock the keypad to prevent accidental key input, Ways include manual and automatic keypad lock, which includes None, 5S, 10S, 15S three options.

1. Press [F] or [J] key to enter the menu mode.
2. Press [F] or [J] key to Settings, and then press [E] key to select.
3. Press [F] or [J] key to radio setting, and then press [E] key to select.
4. Press [F] or [J] key to keypad lock, then press [E] key to select.
5. Press [F] or [J] key to None, 5S, 10S, 15S, the screen shows to select the corresponding time, then keypad will be locked and return to the main screen if user have not any keypad operation after corresponding period of time.
6. To unlock the keypad, press [E] key, then press [#] key.
7. Screen shows unlock keyboard, and then return to the main screen.

### Turn on or off LED

You can turn on or off the screen backlight according to the need. Turn on or off LED as the pre-programmed setting:

1. Press [E] key to enter the menu mode.
2. Press [F] or [J] key to Settings, and then press [E] key to select.
3. Press [F] or [J] key to radio setting, and then press [E] key to select.
4. Press [F] or [J] key to LED, and press [E] key to select.

5. The screen displays on,5sec,15sec,30sec four choices, Select "on " , the screen will remain lit and won't turn off,.If select the other choices ,The screen backlight will be off if user have not any keypad operation after corresponding period of time.

### Conversely Ann Setting

It will trigger the switch When radio fall on the ground horizontal ,not in vertical state. According to your need to set the switch, Whether to raise the alarm the channel pre-set.

1. Press [E] key to enter the menu mode.
2. Press [F] or [J] key to Settings, and then press [E] key to select.
3. Press [F] or [J] key to radio setting, and then press [E] key to select.
4. Press [F] or [J] key to Conversely Ann, and press [E] key to select.
5. Press [F] or [J] key to turn on or turn off , and press [E] key to select.

### Set The Power Level

You can set each channel power level to high or low.

Setting High-power radio implement communications with radios relatively far distance.

Low-power radio implement communications with radios relatively close distance.

Press pre-programmed high / low power selection key, you can switch high / low transmit power.

Using the menu function:

1. Press the [E] key to enter the menu mode.
2. Press [F] or [J] key to Settings, and then press [E] key to select.
3. Press [F] or [J] key to radio setting, and then press the [E] key to select.

4. Press [**↵** or **↩**] key to power, and then press [**⏏**] key to select.
5. Follow the on–screen instructions to change the current settings.
6. Press [**⏏**] key to select the new power level.
7. Return to the previous menu screen. Press [**⏏**] to return to the main screen, the screen displays the power level icon H or L.

### Zone Setting

Change to different zone according to need.

1. Press the [**⏏**] key to enter the menu mode.
2. Press [**↵** or **↩**] key to Settings, and then press [**⏏**] key to select.
3. Press [**↵** or **↩**] key to radio setting, and then press the [**⏏**] key to select.
4. Press [**↵** or **↩**] key to Zone, and then press [**⏏**] key to select.
5. Follow the on–screen instructions to change the current settings.
6. Press [**⏏**] key to select the new zone.
7. Return to the previous menu screen.

### Date & Time Setting

Time Setting divided into:

- Date
- Time
- Date format

#### Date

1. Press the [**⏏**] key to enter the menu mode.

2. Press [**↵** or **↩**] key to Settings, and then press [**⏏**] key to select.
3. Press [**↵** or **↩**] key to radio setting, and then press the [**⏏**] key to select.
4. Press [**↵** or **↩**] key to Date &Time, and then press [**⏏**] key.
5. Press [**↵** or **↩**] key to Date, and then press [**⏏**] key to display the current date .
6. Press [**⏏**] key to enter date setting interface.
7. Press [**↵** or **↩**] key to move left and right to select the desired number, the selected number will reverse video display ,then enter the corresponding numbers to change the date via the numeric keypad.
8. Press [**⏏**] key to save, the screen displays the date has been saved.

#### Time

1. Press the [**⏏**] key to enter the menu mode.
2. Press [**↵** or **↩**] key to Settings, and then press [**⏏**] key to select.
3. Press [**↵** or **↩**] key to radio setting, and then press the [**⏏**] key to select.
4. Press [**↵** or **↩**] key to Date &Time, and then press [**⏏**] key.
5. Press [**↵** or **↩**] key to Time, and then press [**⏏**] key to display the current time .
6. Press [**⏏**] key to enter time setting interface.
7. Press [**↵** or **↩**] key to move left and right to select the desired number, the selected number will reverse video display ,then enter the corresponding numbers to change the date via the numeric keypad.
8. Press [**⏏**] key to save, the screen displays the time has been saved.

#### Date format

1. Press the [⏏] key to enter the menu mode.
2. Press [↵] or [⏏] key to Settings, and then press [⏏] key to select.
3. Press [↵] or [⏏] key to radio setting, and then press the [⏏] key to select.
4. Press [↵] or [⏏] key to Date & Time, and then press [⏏] key.
5. Press [↵] or [⏏] key to date format, and then press [⏏] key to display the current time .
6. Press [↵] or [⏏] key to select the date format you want .
7. Press [⏏] key to save, the screen displays the time has been saved.

### Tone Setting

- Tone divided into
- Profiles
- keypad tone set
- power tone set
- Msg tones

### Profiles

1. Press the [⏏] key to enter the menu mode.
2. Press [↵] or [⏏] key to Settings, and then press [⏏] key to select.
3. Press [↵] or [⏏] key to radio setting, and then press the [⏏] key to select.
4. Press [↵] or [⏏] key to Tone, and then press [⏏] key.
5. Press [↵] or [⏏] key to profiles, and then press [⏏] key.
6. Press [↵] or [⏏] key to select General or Silent according to your need.
7. Press [⏏] key to save.

### Keypad tone set

1. Press the [⏏] key to enter the menu mode.
2. Press [↵] or [⏏] key to Settings, and then press [⏏] key to select.
3. Press [↵] or [⏏] key to radio setting, and then press the [⏏] key to select.
4. Press [↵] or [⏏] key to Tone, and then press [⏏] key.
5. Press [↵] or [⏏] key to keypad tone set, and then press [⏏] key.
6. Press [↵] or [⏏] key to select KeyRingon or KeyRingoff according to your need.
7. Press [⏏] key to save.

### Power Tone set

1. Press the [⏏] key to enter the menu mode.
2. Press [↵] or [⏏] key to Settings, and then press [⏏] key to select.
3. Press [↵] or [⏏] key to radio setting, and then press the [⏏] key to select.
4. Press [↵] or [⏏] key to Tone, and then press [⏏] key.
5. Press [↵] or [⏏] key to power tone set, and then press [⏏] key.
6. Press [↵] or [⏏] key to select CouloToneon or CouloToneoff according to your need.
7. Press [⏏] key to save.

### Message Tones

1. Press the [⏏] key to enter the menu mode.
2. Press [↵] or [⏏] key to Settings, and then press [⏏] key to select.
3. Press [↵] or [⏏] key to radio setting, and then press the [⏏] key to select.
4. Press [↵] or [⏏] key to Tone, and then press [⏏] key.

5. Press [F] or [J] key to Message Tones selection, and then press [E] key.
6. Press [F] or [J] key to select Ring1 to Ring5 according to your need.
7. Press [E] key to save.

### GPS Setting

1. Press the [E] key to enter the menu mode.
2. Press [F] or [J] key to Settings, and then press [E] key to select.
3. Press [F] or [J] key to radio setting, and then press the [E] key to select.
4. Press [F] or [J] key to GPS , and then press [E] key.
5. Press [F] or [J] key to select GPS on or off .
6. Press [E] key to save.

### GPS information

GPS function of the machine starts when switch on the GPS ,After Locked by the GPS , Latitude and longitude information shows here.

1. Press the [E] key to enter the menu mode.
2. Press [F] or [J] key to Settings, and then press [E] key to select.
3. Press [F] or [J] key to GPS information, and then press the [E] key to enter in.

### RX GPS information

Here you can see the GPS positioning information send from the other radios .

1. Press the [E] key to enter the menu mode.
2. Press [F] or [J] key to Settings, and then press [E] key to select.
3. Press [F] or [J] key to Rx GPS information, and then press the [E] key to enter in.

## Specifications

### General

Frequency Range	VHF:136–174MHz UHF: 400–470MHz
Channel capacity	1024 Channels
Channel spacing	12.5KHZ
Working voltage	7.8V
Battery type	LI-ON
Working temperature	-40°C+85°C
Antenna Impedance	50 Ω
Audio output power	≤1000Mw@16
Dimension	144*59*40mm

### Receiver

Analog sensibility	0.35uV/-116dBm(20dB SINAD) 0.22 uV/-120dBm(Type)
Digital sensibility	0.3 uV/-117.4dBm(BER 5%) 0.7 uV/-110dBm(BER 1%)
Common channel Rejection	≥-12dB
Adjacent channel selectivity	TIA603C: 65dB ETSI: 60dB
Spurious response	TIA603C: 75dB ETSI: 70dB

Rated audio power	≤ 1W
Rated audio distortion	3%(Type)
Audio response	=1dB~-3dB
<b>Transmitter</b>	
Output power	High: 10W Low: 4 W
Frequency stability	+/- 1.0ppm
Adjacent channel Power	≤ -60dB
Free time slot power	TDMA: ≤ -57dBm
FM modulation mode	12.5KHZ:11K0F3E
Modulation Deviation	2.5KHZ:@12.5KHZ
Nonactive slot power	-57dBm
Digital protocol	ETSI TS 102 361-1-2-3
Vocoder type	AMBE+2TM
Modulation BER(Bit error rate)	≤ 5%
4FSK digital mode	12.5KHz(data only):7K60FXD 12.5KHz(data+voice):7K60FXE



## Warranty card

**Note:**

1. This warranty card is only applicable to two-way radio of the above-listed model and serial number.
2. The warranty card is an important document for the end-user to enjoy warranty service, please keep it well.
3. The warranty card shall be filled and chopped by the dealer, or it is invalid.

Customer's name:

Gender:

Add and postal code:

Customer's Tel:

Model:

Serial number:

Purchasing date:

Invoice No.:

Dealer:

Stamp:

Add and postal code of the dealer:

Contact Tel:

Handling people:



Thank you for buying TYT two-way radios, we will do our best to provide you with a stable, clear and efficient wireless communication services. In order for you to enjoy a better quality warranty service, please focus on the following information:

The products warranty period begins from the purchasing date, if product failure under normal use within warranty period occurs, according to the contents of this warranty, (the radio is guaranteed for 12 months, accessories 6 months), please carry the warranty card originals and purchase invoice to TYT designated authorized warranty repair station for warranty service.

The following situations occur during warranty period will be implemented in paid service:

- (1) Failure to produce the warranty card
- (2) The card has altered traces or inconsistent with the product
- (3) Defect or damage caused by abnormal or non-normal use
- (4) Defect or damage caused by misuse, accident, water or negligence
- (5) Defect or damage caused by improper testing, operation, maintenance, installation, disassembly or adjustment
- (6) Defect or damage caused by unauthorized repair or disassembly
- (7) Defect or damage caused by force majeure
- (8) Wear and tear under normal use

When you are in need of repair, please send the radio, warranty card and purchase invoice together by post or take directly to TYT designated authorized service stations, shipping costs should be borne by the user.

### Maintenance record

Carry-in date			
Completion date			
Fault description			
Maintenance staff numbers			
Maintenance personnel No.			
Signature			

This warranty card to be kept by the user, no replenishment if lost

